

Community Helper Printable Crafts



Printable crafts are easy to print crafts where all you need are scissors, crayons – markers and glue.

Print up craft sheets on white card stock. This will make the finished craft more durable.

You can locate card stock at office supply stores, or local stores like Target, Wal Mart, Sam's Club or K-Mart in the office supply section.

Community Helper Sequencing

- Print up the sheet with the 3 community helpers on white card stock.
- Give to the children to color and cut out.
- Glue them in sequence – Largest to smallest.
- (Print up the sequence – Largest to smallest sheet on card stock. Or hand print the information on a piece of construction paper.)

- Police
- Firefighter
- Doctor

Name _____

Community Helper Sequencing
Large to Small

Large

Medium

Small

Astronaut Sequencing

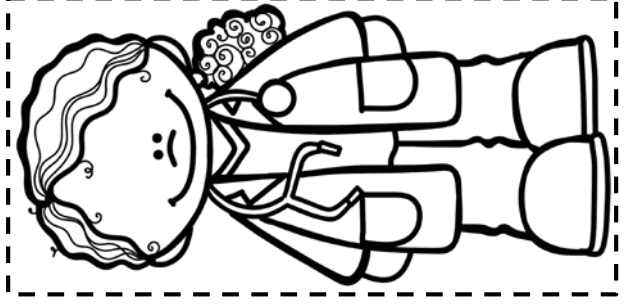
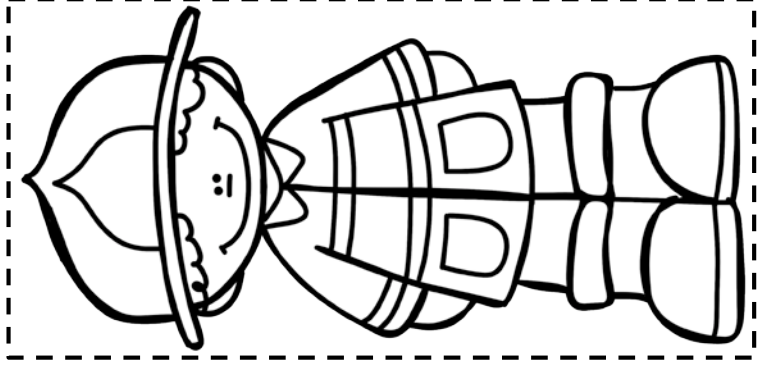
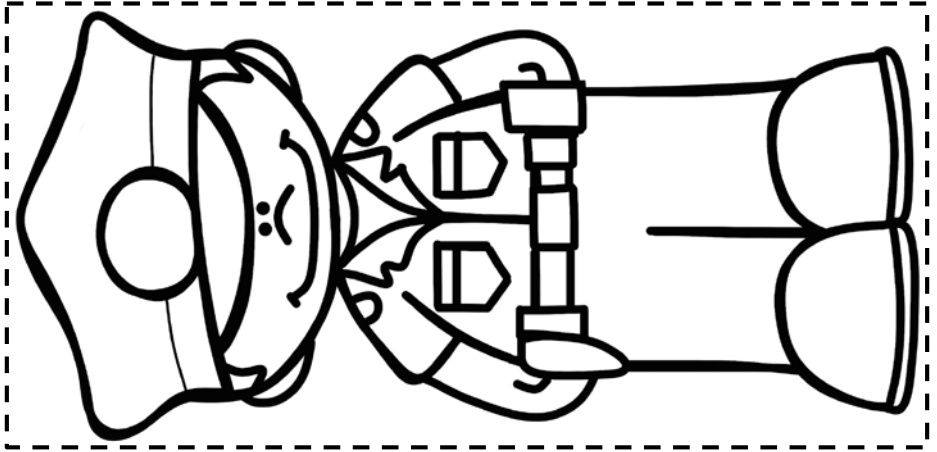

Community Helper Hat

- One sheet per child.
- Print up on white card stock.
- Have child color or paint.
- Cut out both strips.
- Connect both strips to make a band.
- Fit to child's head and staple together to form a hat. If needed, for additional strip, cut strip from another sheet.

You have the option of several hats. Let children pick the community helper hat they would like to make.

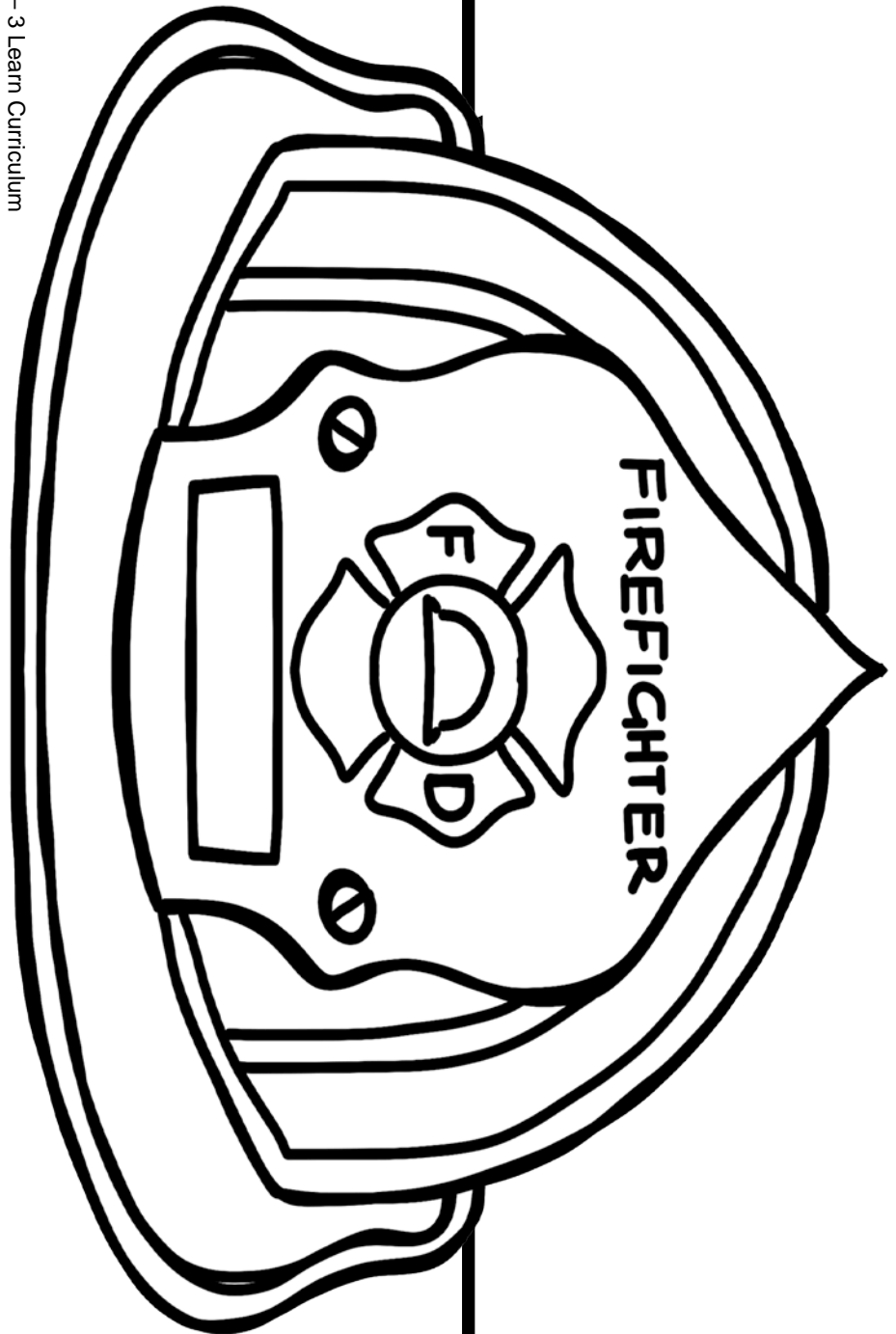

What I need to Do My Job!

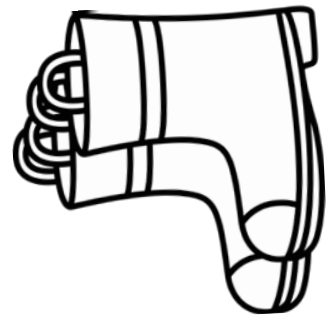
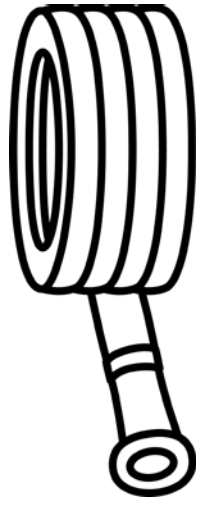
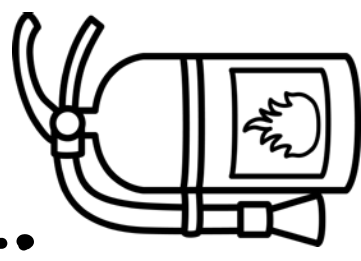

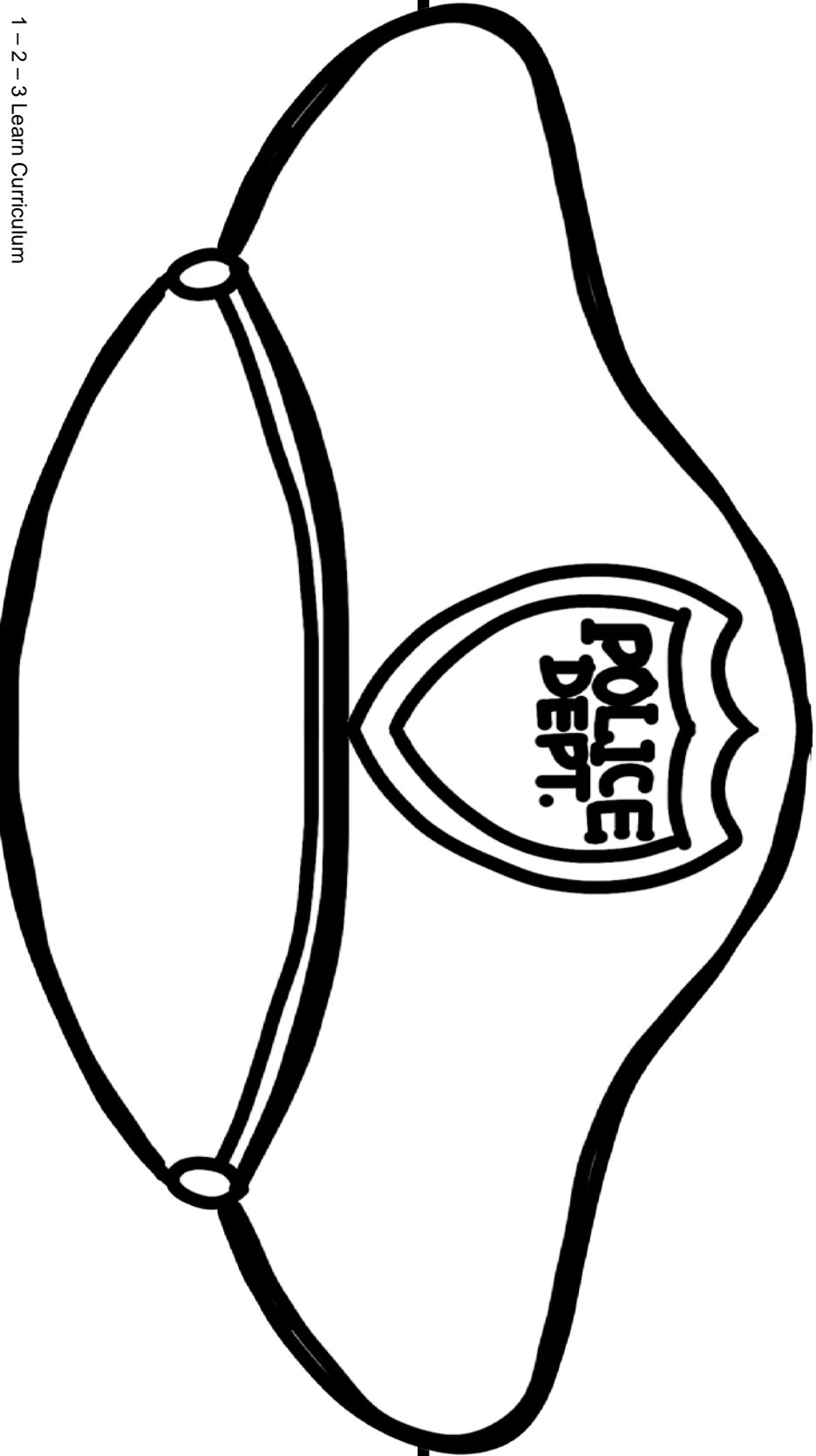

What I need to Do My Job!

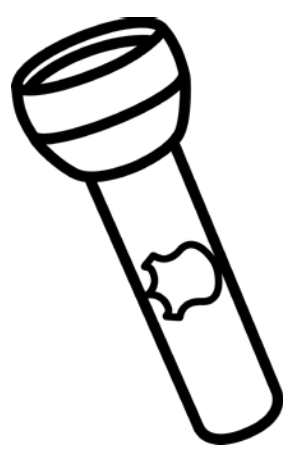
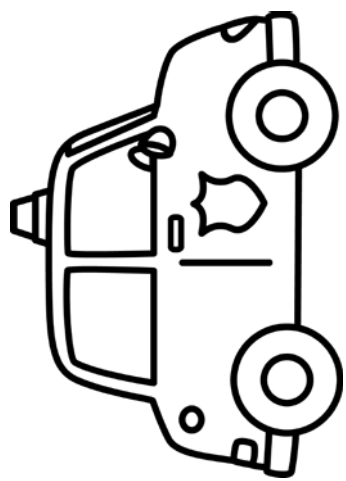

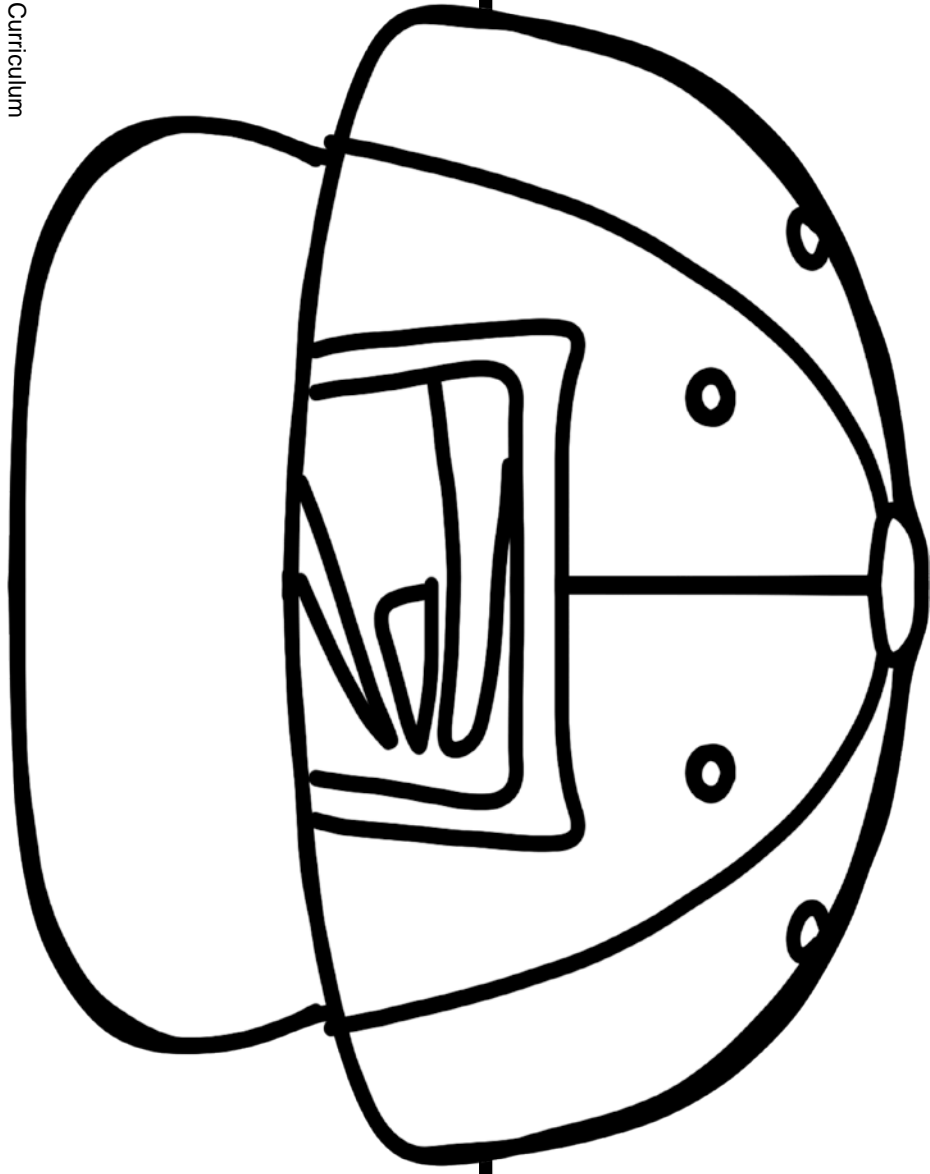

What I need to Do My Job!

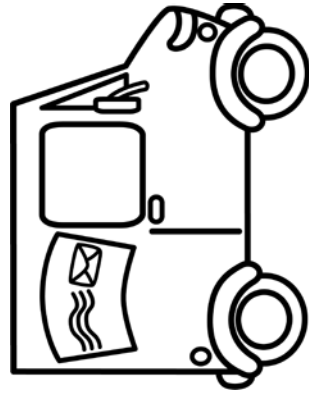

Postal
Worker

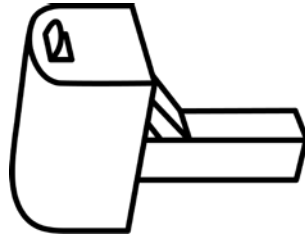
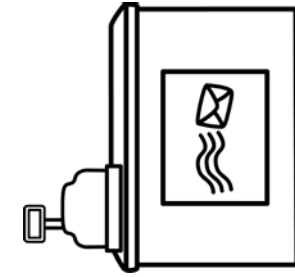

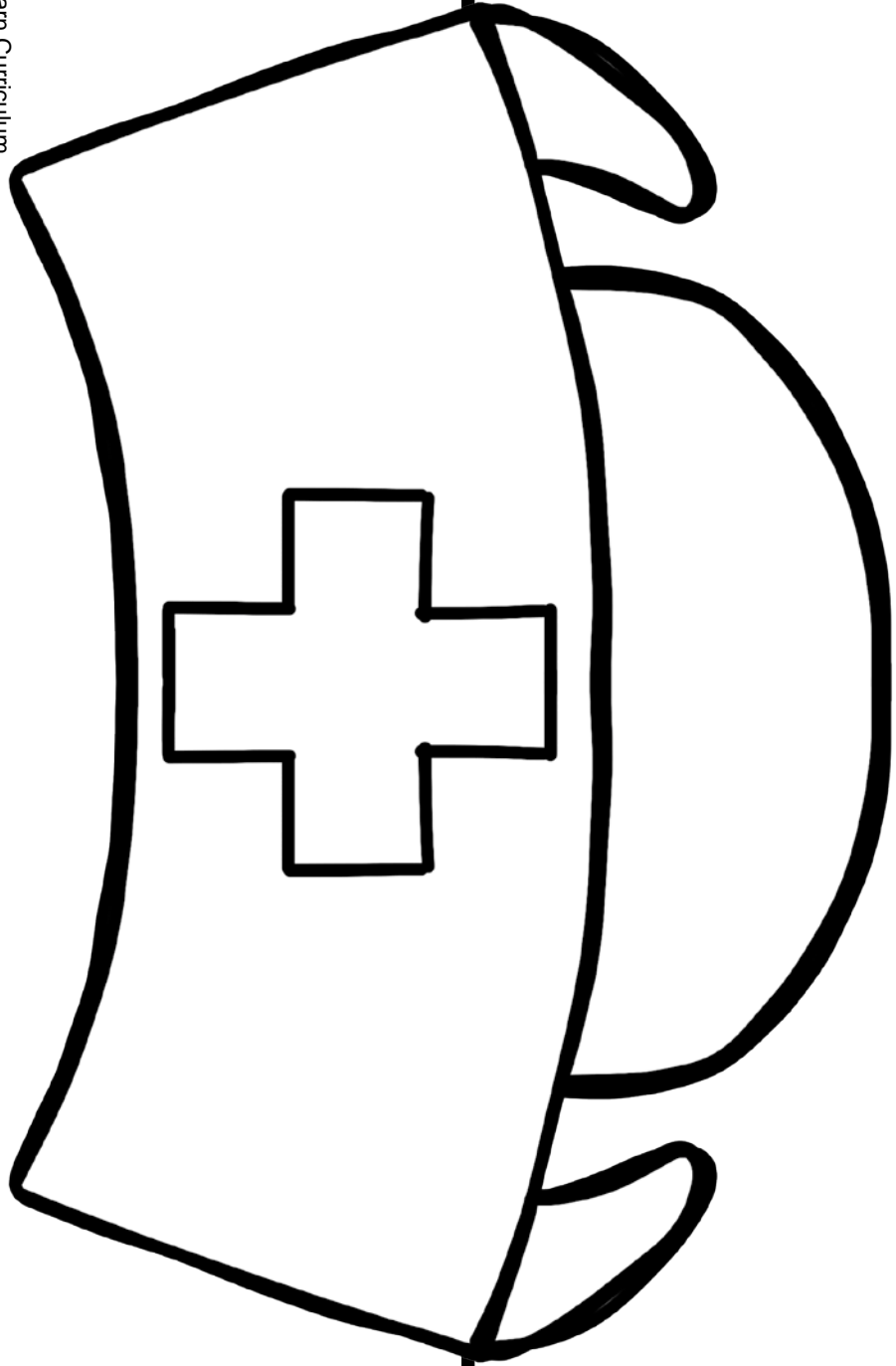

What I need to Do My Job!

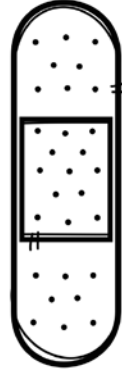
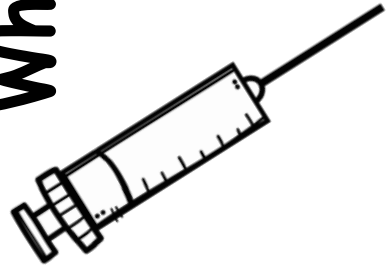

Nurse

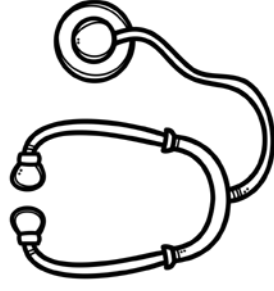

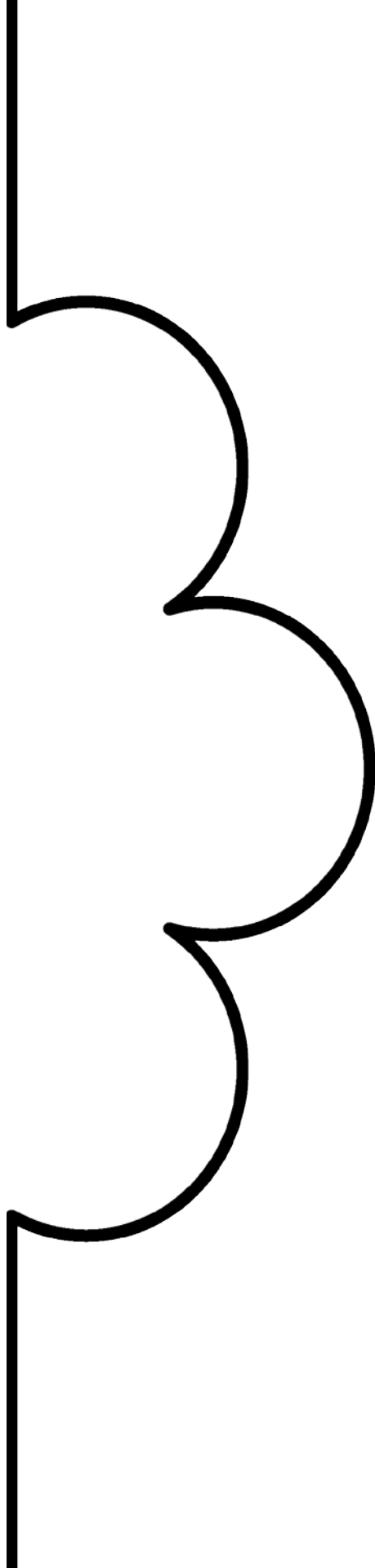

It's Out of This World

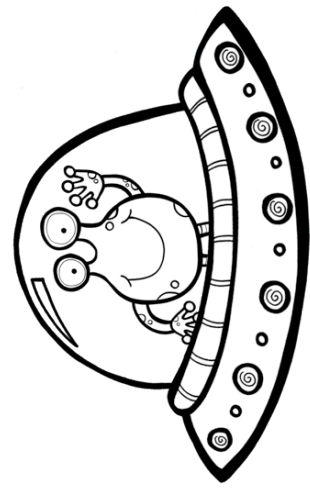

Community Helper Mobile - Hospital



Supplies needed:

- White card stock
- Crayons or markers
- Scissors
- Hole punch
- Yarn

Directions:

Print up mobile onto white card stock.

Have children color and cut out on the dotted lines.

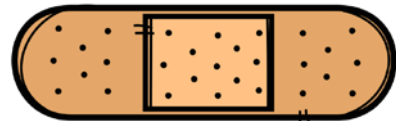

- Punch holes in the pieces, using a hole punch. (Picture of a hole punch to the right).
- Using yarn, attach all the pieces of the mobile. (Attach a piece of yarn at the top and hang from the ceiling during community helper week).



Hole punch – find at any local craft store or office supply section.

Print up on white card stock.

Punch hole with a hole punch on the top where there is a small circle and towards the bottom of the hospital.

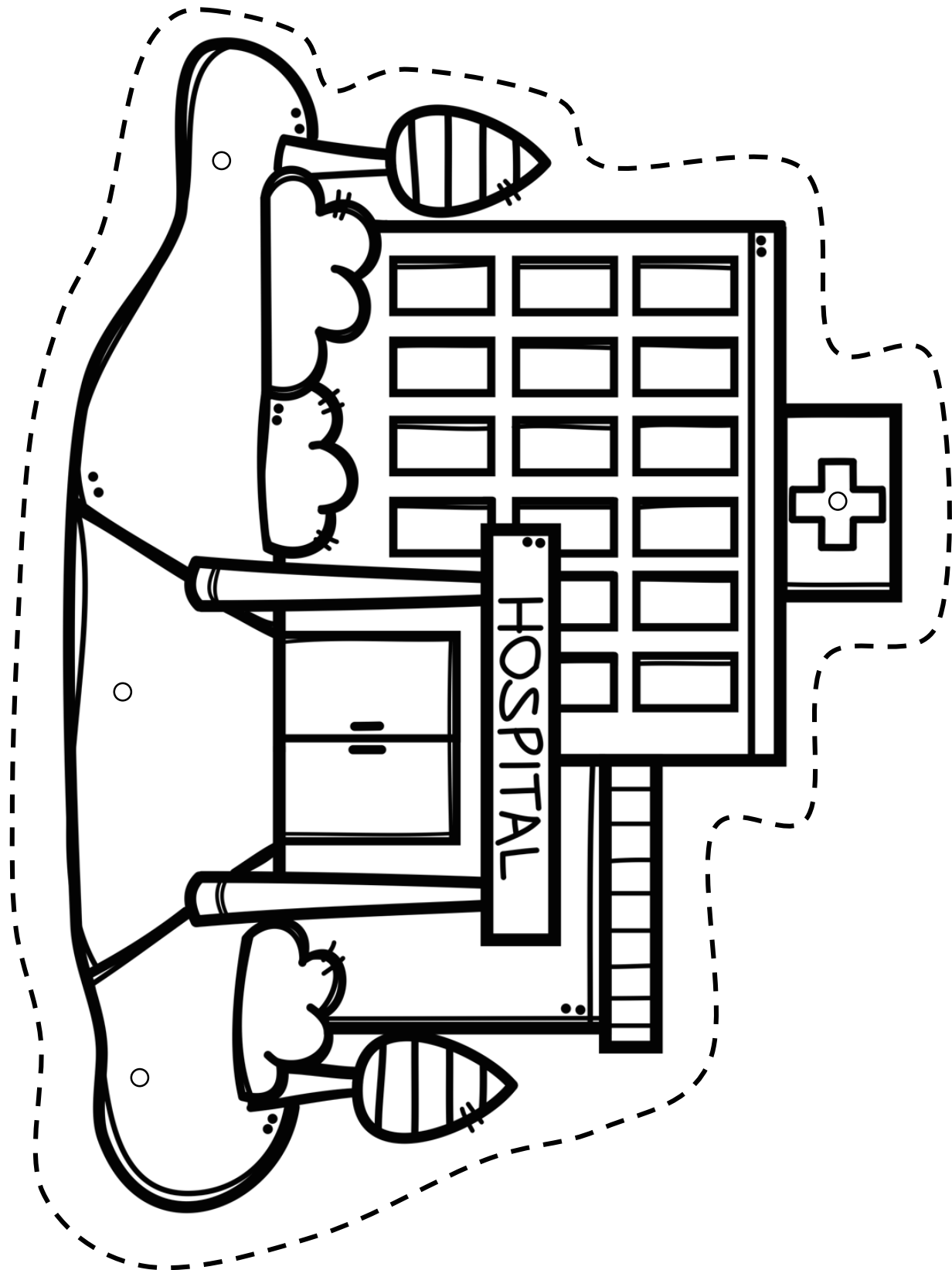

Print up on white card stock.
Punch hole with a hole punch,
and add people who work at a
hospital with yarn.

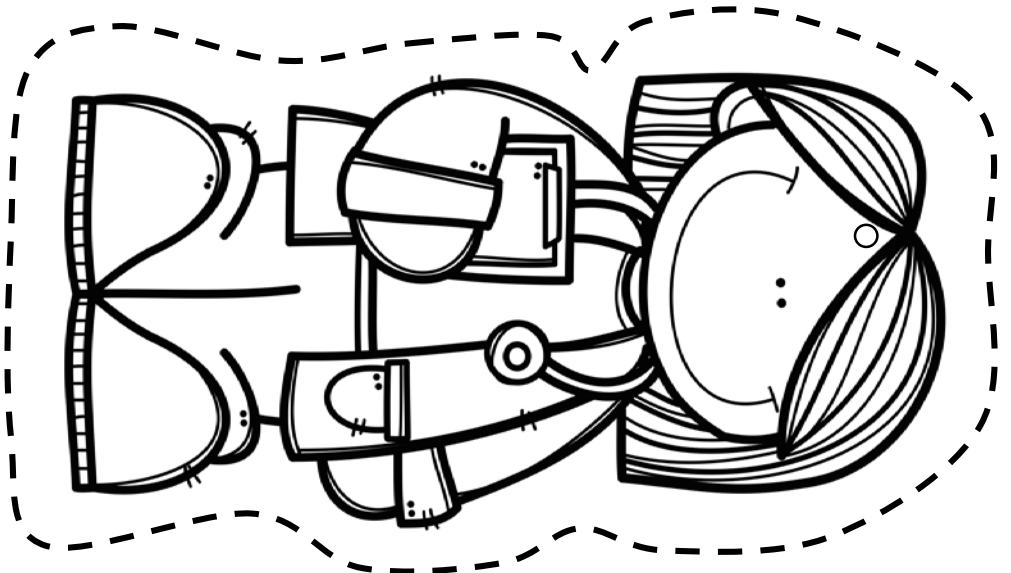

Community Helper Mobile – Firefighters

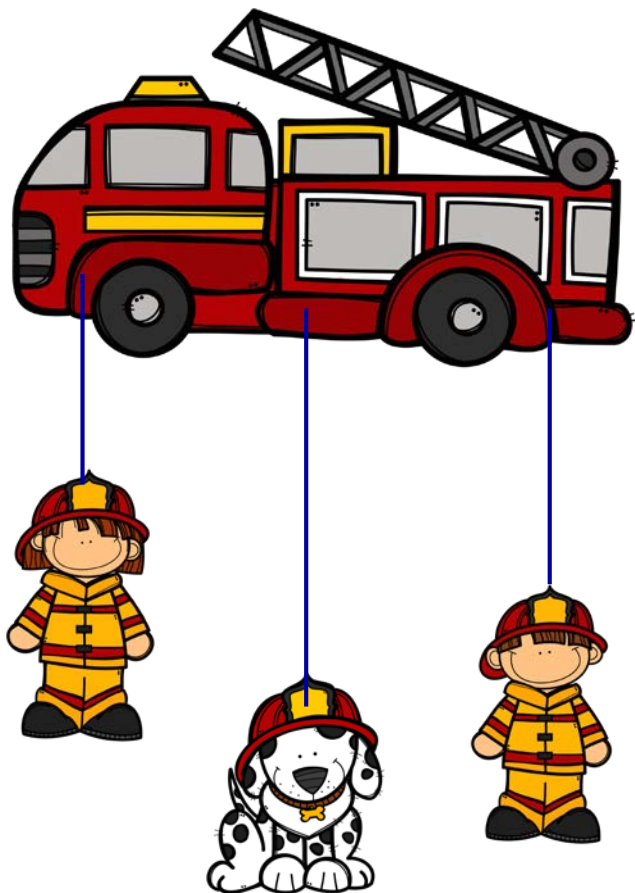

Supplies needed:

- White card stock
- Crayons or markers
- Scissors
- Hole punch
- Yarn

Directions:

Print up mobile onto white card stock.
Have children color and cut out on the dotted lines.



- Punch holes in the pieces, using a hole punch. (Picture of a hole punch to the right).
- Using yarn, attach all the pieces of the mobile. (Attach a piece of yarn at the top and hang from the ceiling during community helper week).

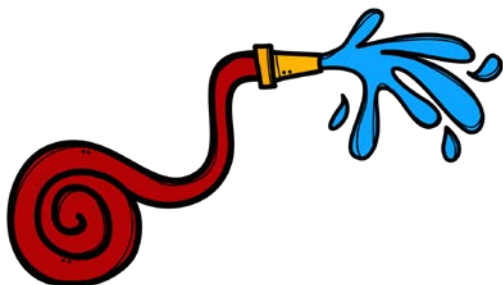

Hole punch – find at any local craft store or office supply section.

Print up on white card stock.

Punch hole with a hole punch on the top where there is a small circle and towards the bottom of the firetruck.

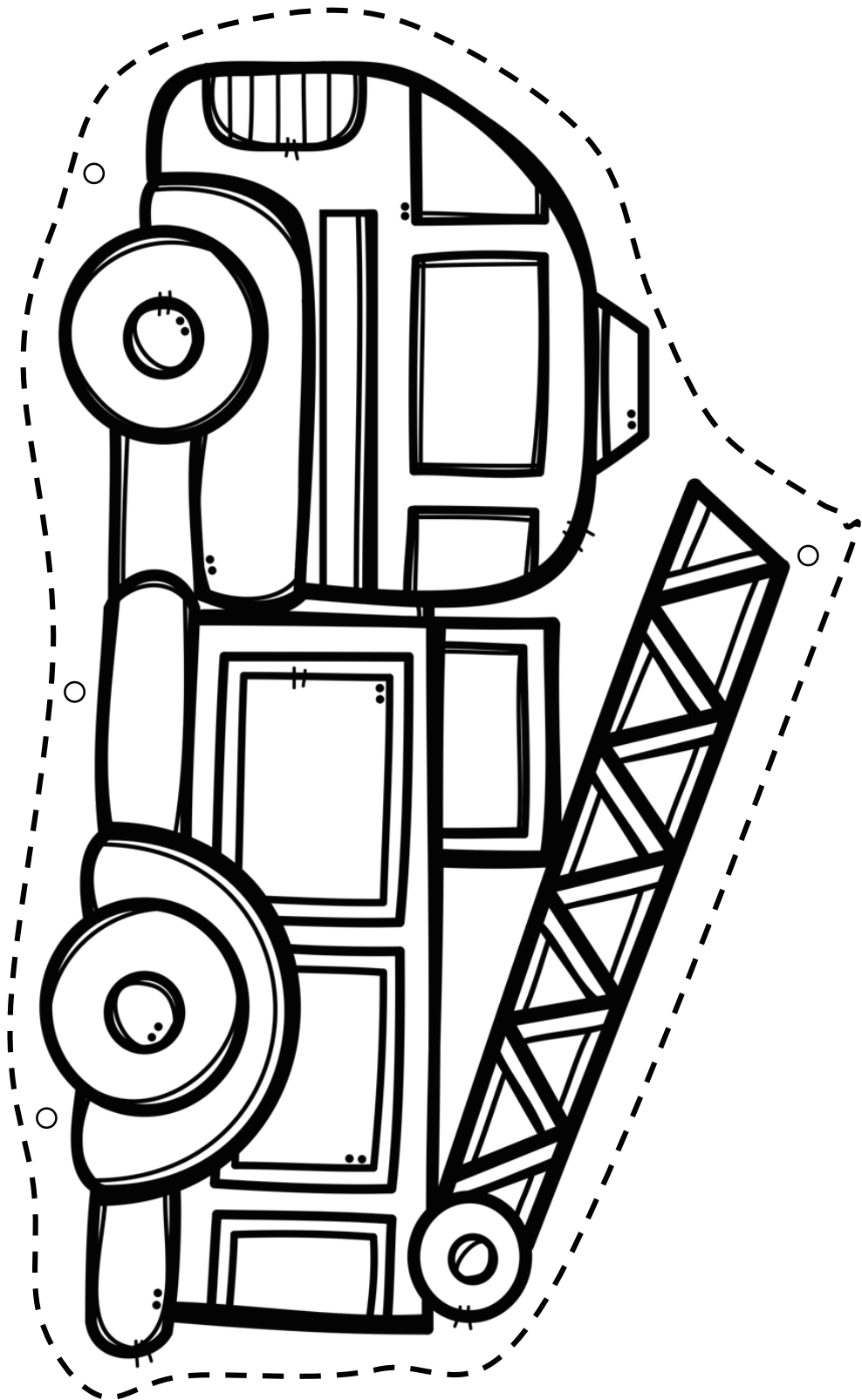

Print up on white card stock.
Punch hole with a hole punch,
attach to fire truck with yarn.

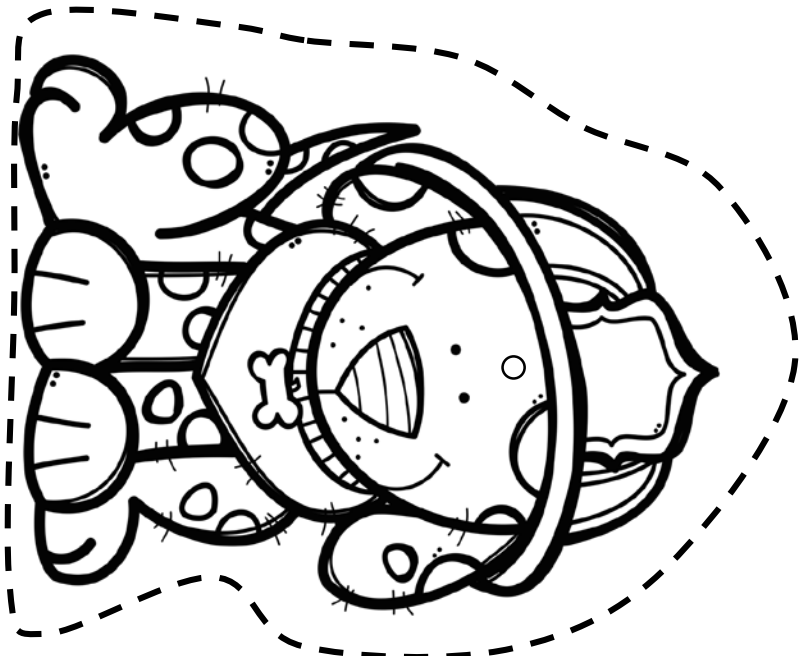
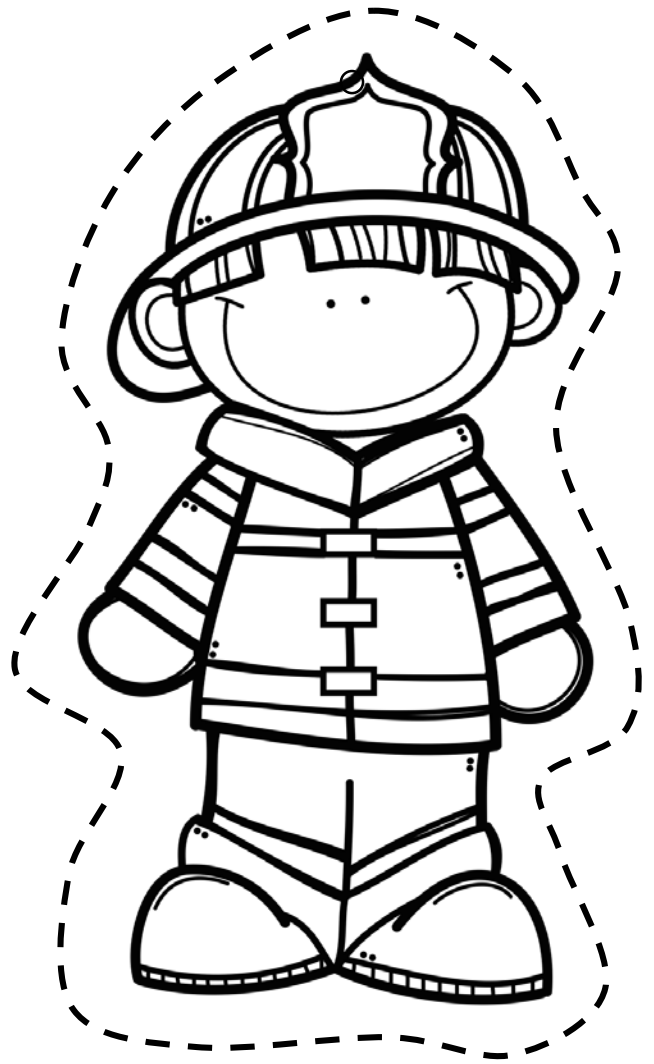
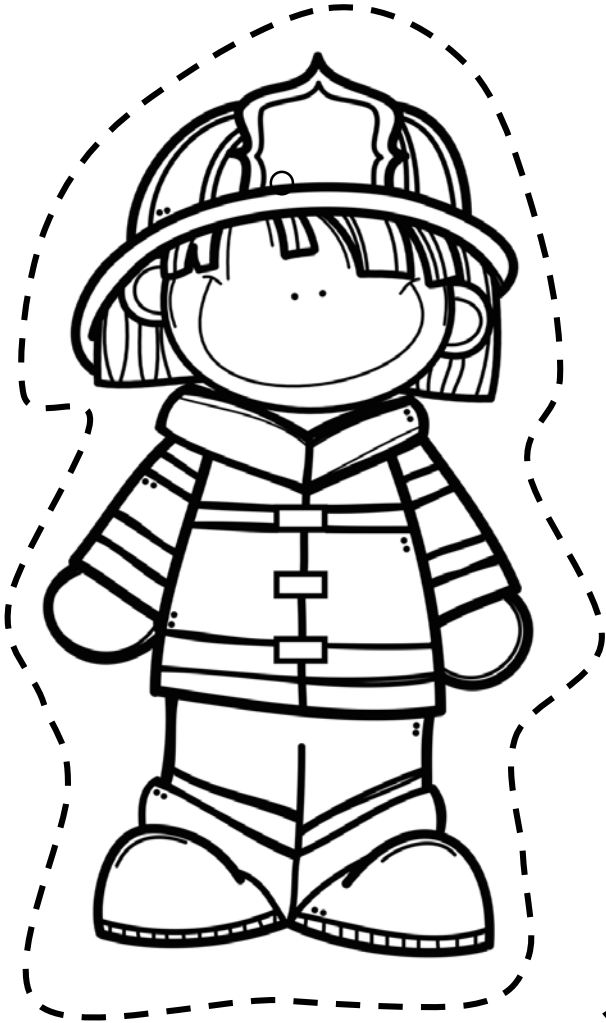

Community Helper Mobile – Police

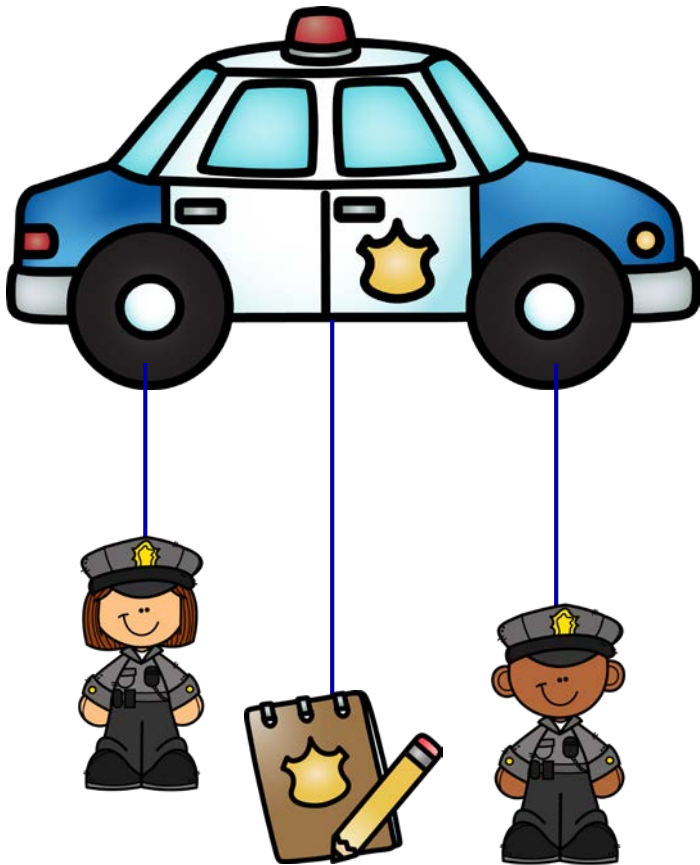

Supplies needed:

- White card stock
- Crayons or markers
- Scissors
- Hole punch
- Yarn

Directions:

Print up mobile onto white card stock.
Have children color and cut out on the dotted lines.



- Punch holes in the pieces, using a hole punch. (Picture of a hole punch to the right).
- Using yarn, attach all the pieces of the mobile. (Attach a piece of yarn at the top and hang from the ceiling during community helper week).



Hole punch – find at any local craft store or office supply section.

Print up on white card stock.

Punch hole with a hole punch on the top where there is a small circle and towards the bottom of the police car.

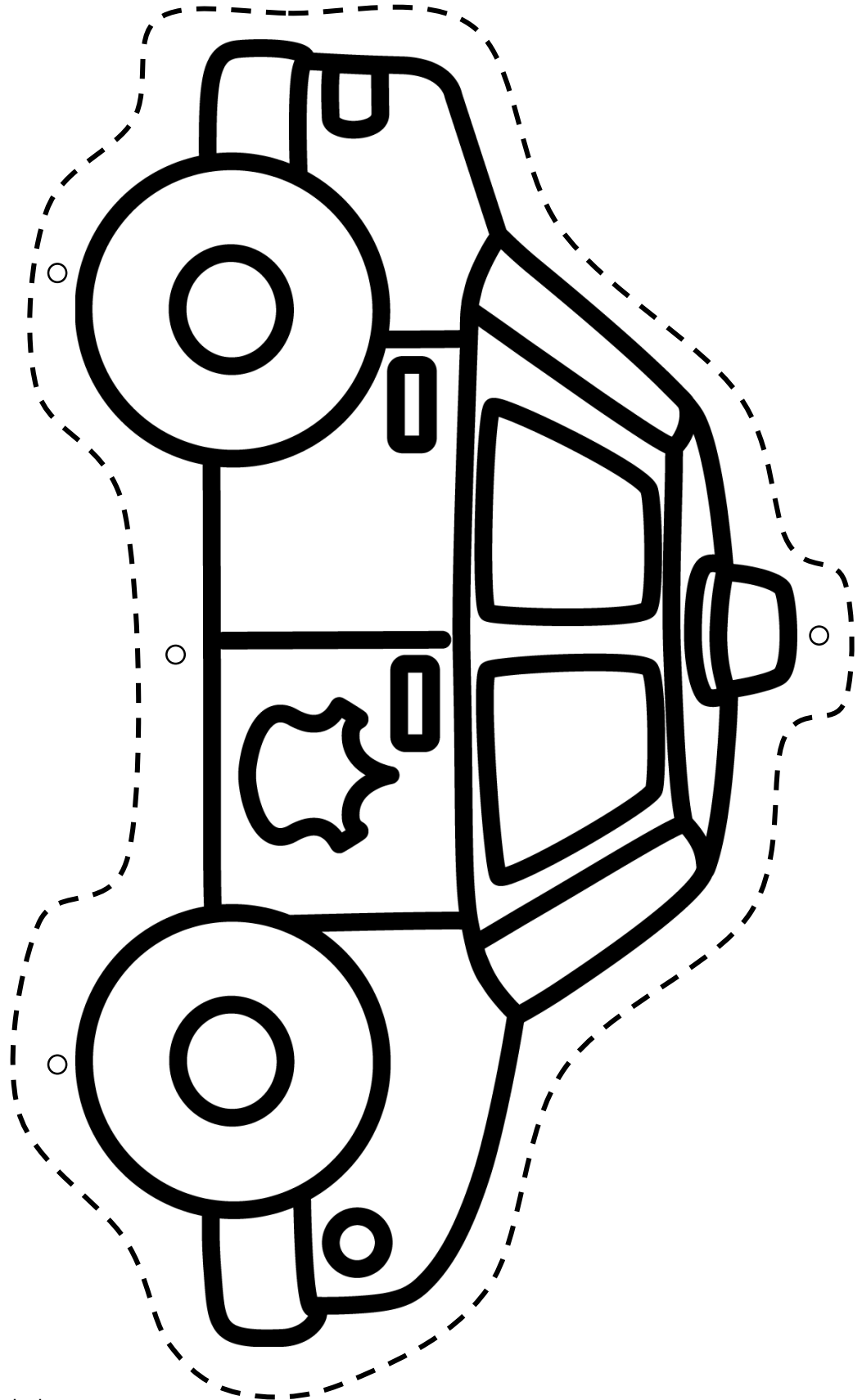

Print up on white card stock.
Punch hole with a hole punch,
and attach police items with yarn.

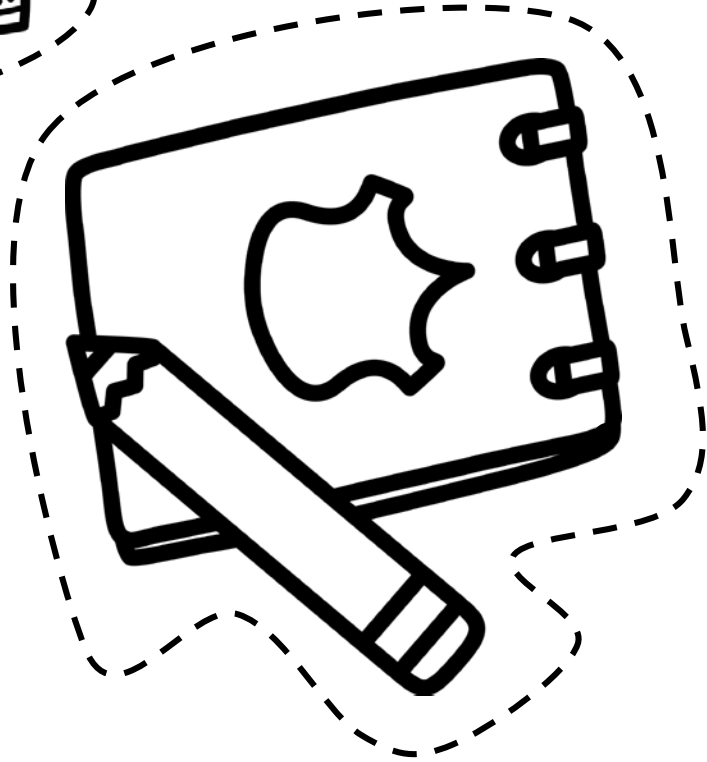
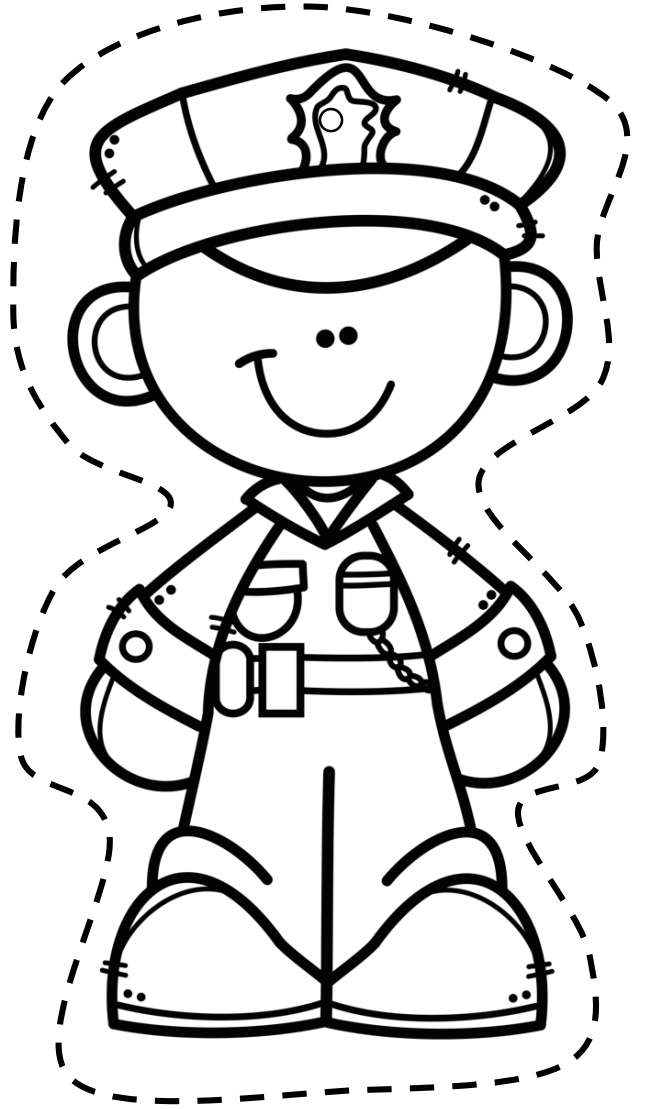
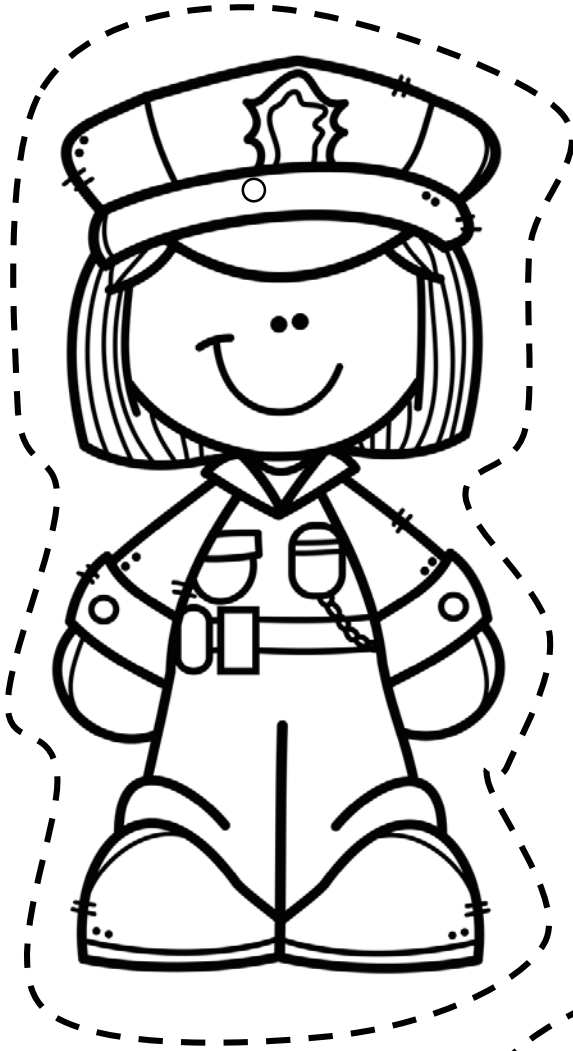

Community Helpers Bookmarks

Print up on white card stock. Give each child a book marker to color. Cut out. Have adult punch a hole at the top. Run a piece of yarn through the hole to create a tassel. Laminate if desired.



Community Helpers

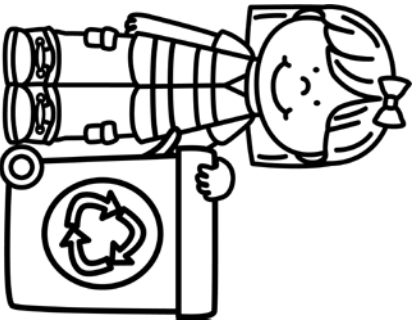

Read all about
the community
helpers in your
neighborhood!



Community Helpers

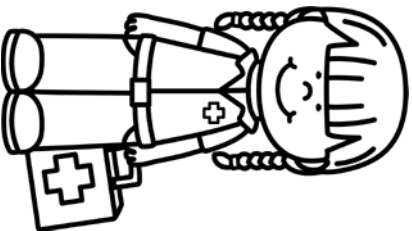

Read all about
the community
helpers in your
neighborhood!



Community Helpers

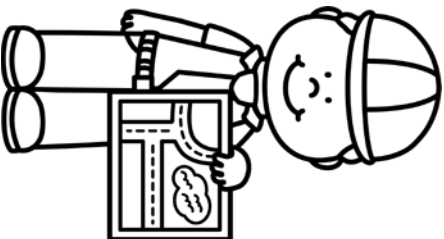

Read all about
the community
helpers in your
neighborhood!



Community Helpers

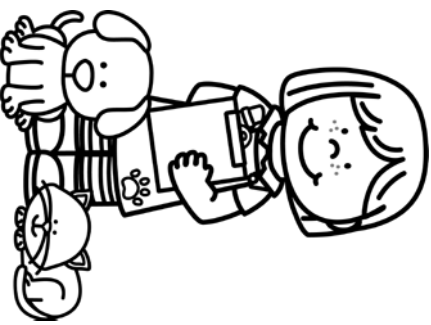

Read all about
the community
helpers in your
neighborhood!

Community Helper Necklace

- Print up on white card stock. Color and cut out community helper necklace.
- Make a hole in the top of the badge. Pull a length of yarn or string through the hole.
- Thread round cereal or colored noodles on each side of the community helper necklace.
- Tie both ends of the yarn together to make a necklace.

You have several templates of this activity. Let children pick the community helper they would like to make.

Community Helper Necklace

Police



Community Helper Necklace

Firefighter

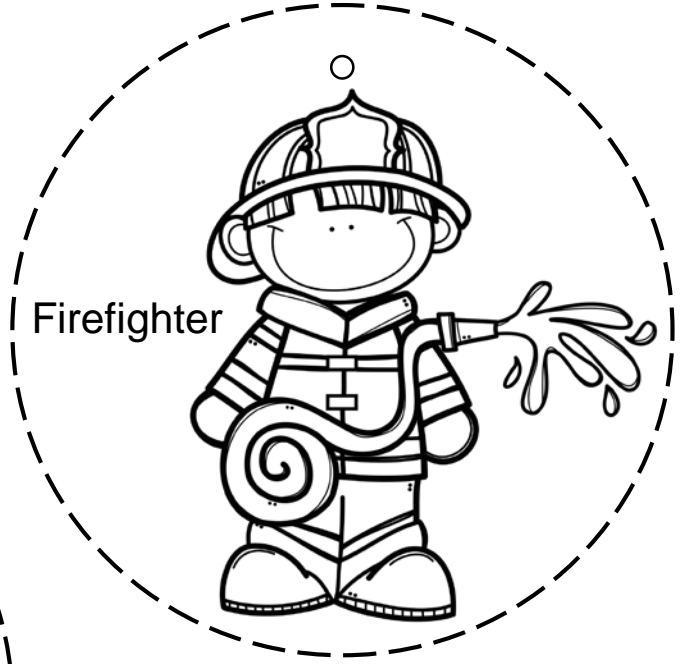
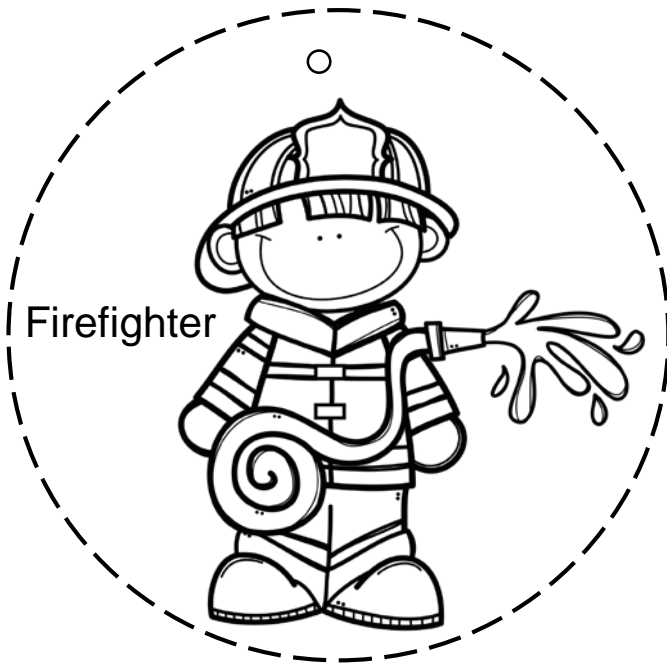
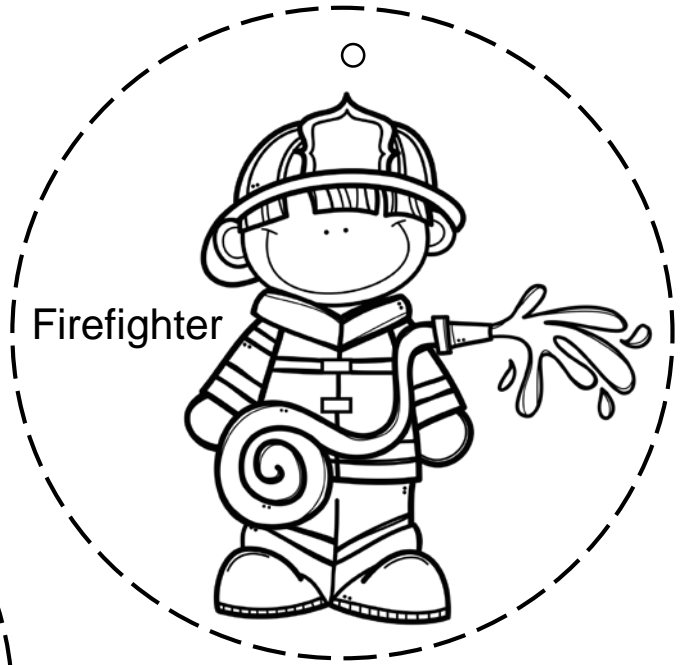
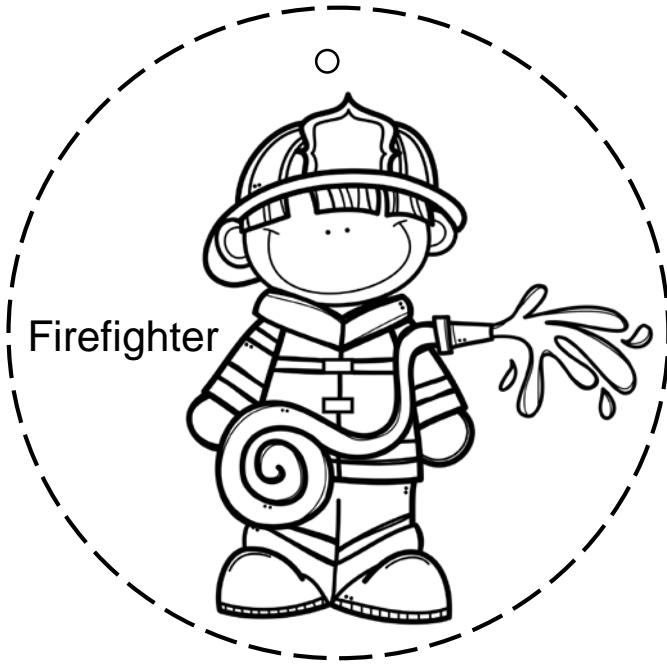

Community Helper Necklace

Paramedic

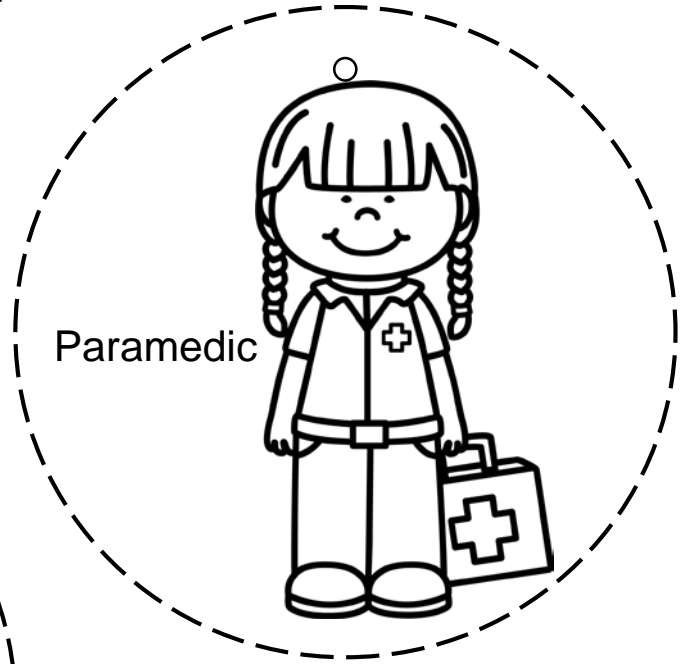
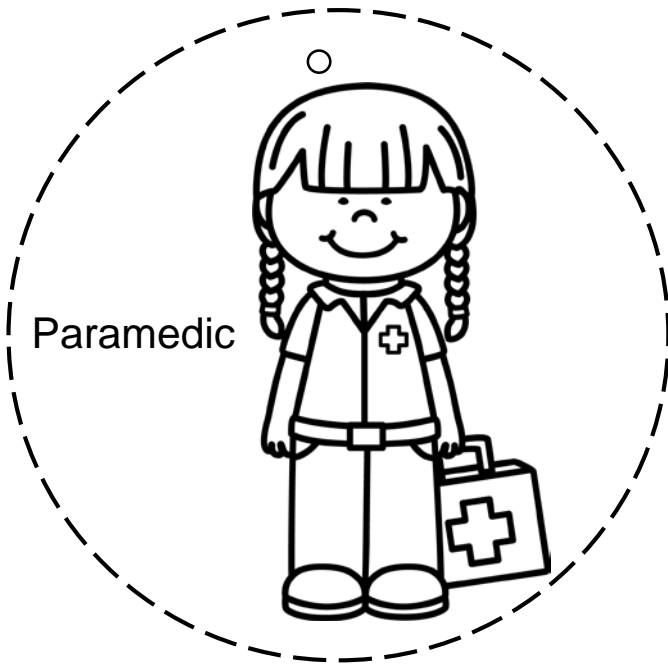
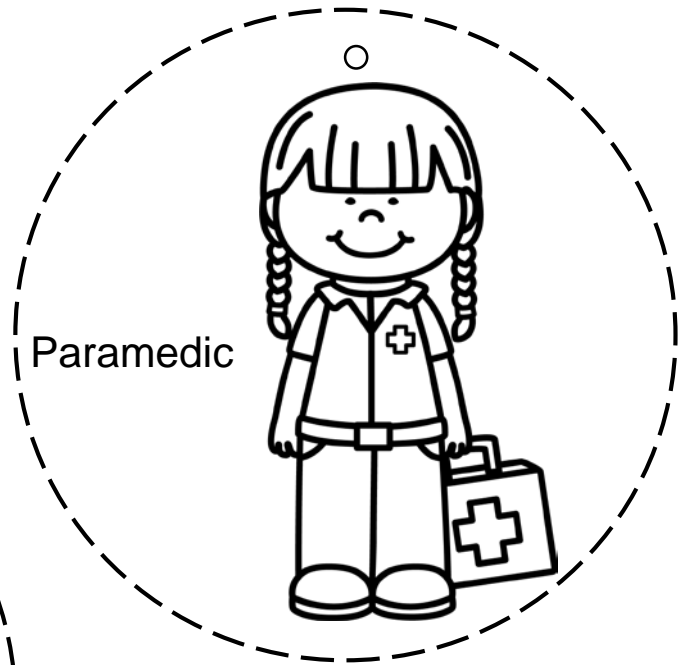
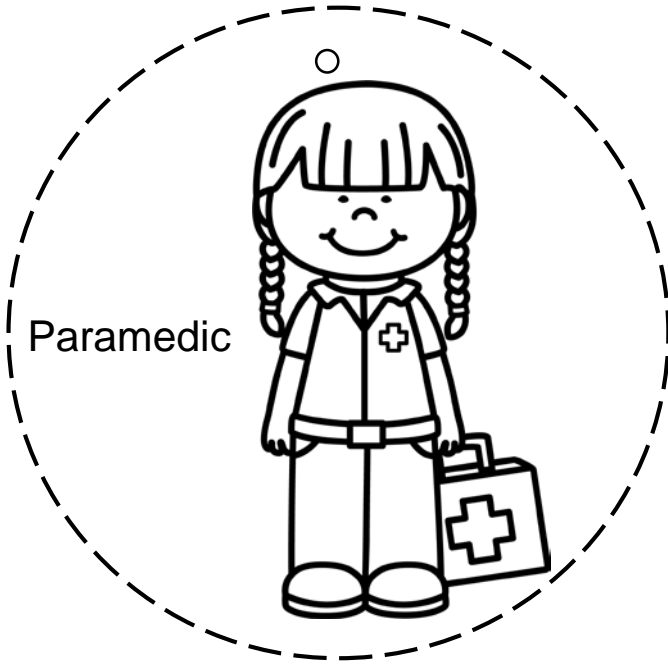

Community Helper Necklace

Dentist

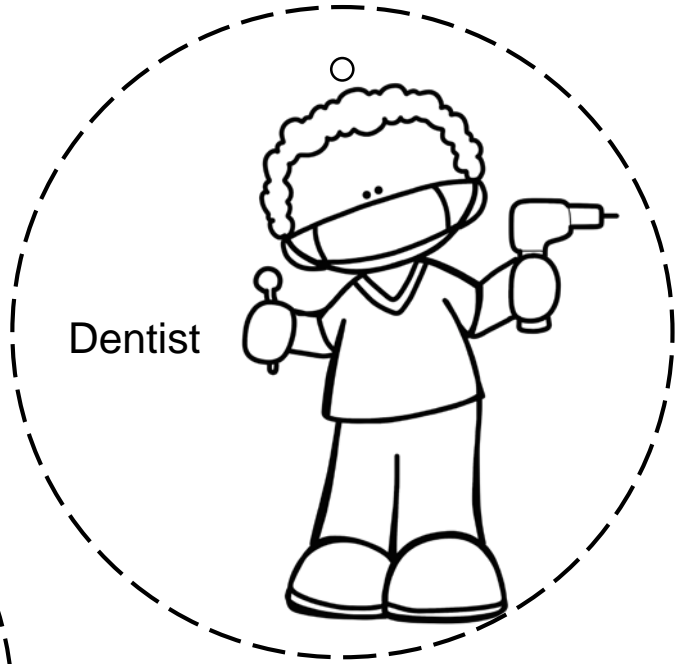
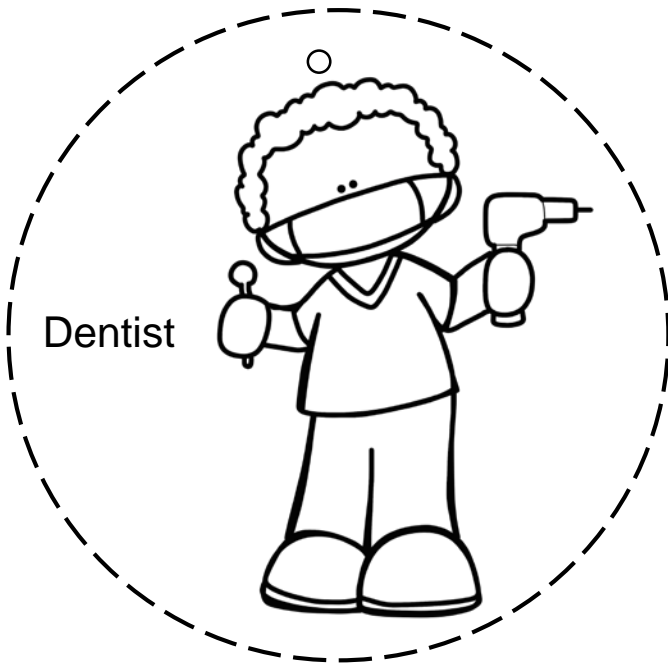
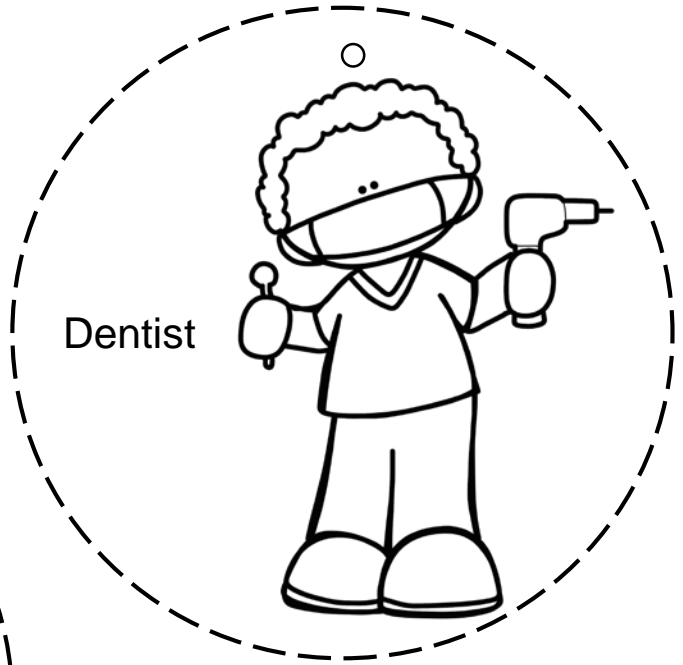
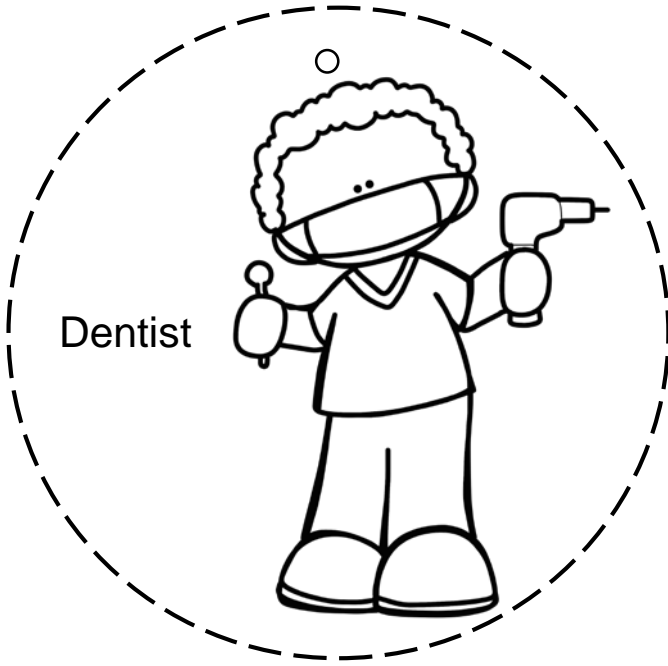

Community Helper Necklace

Trash Hauler

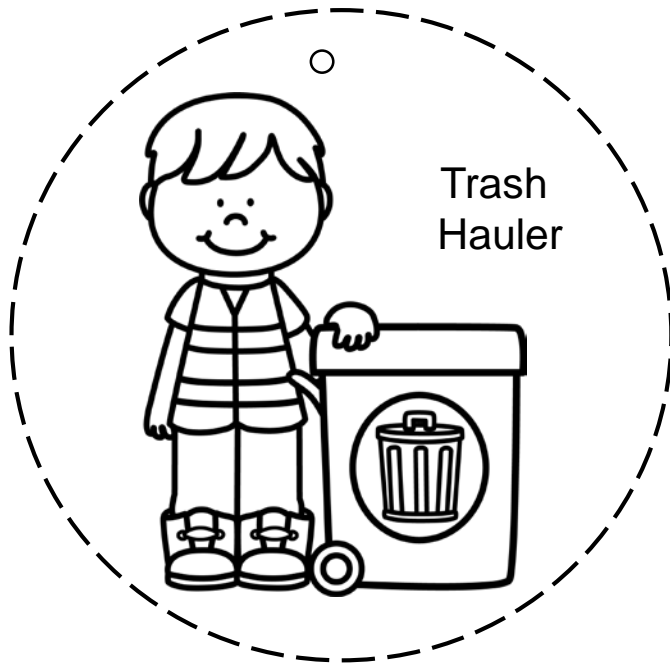
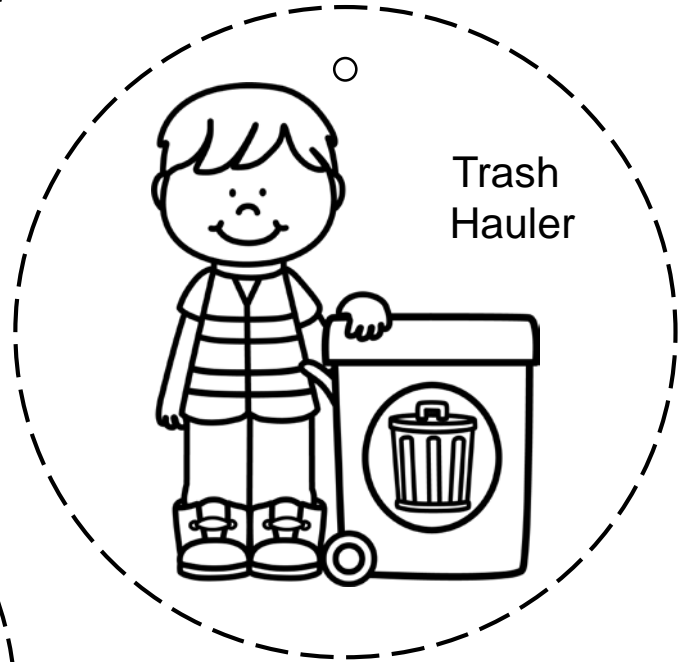
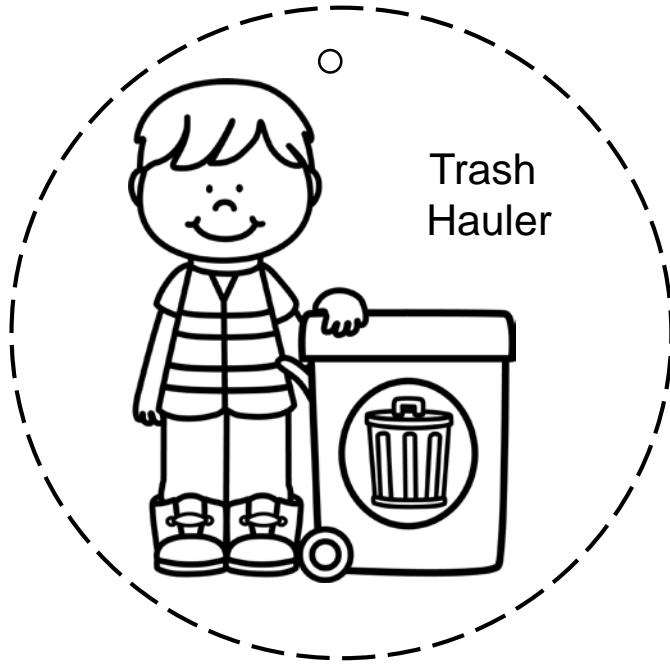
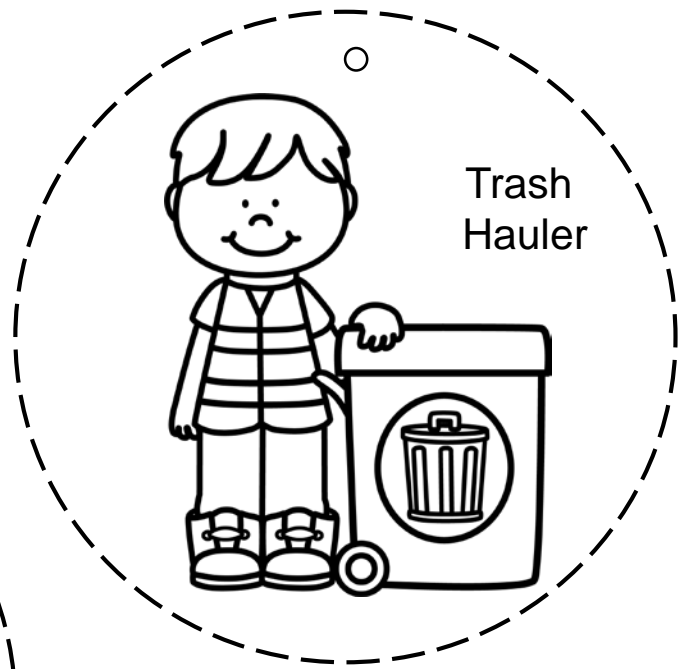

Community Helper Necklace

Postal Worker

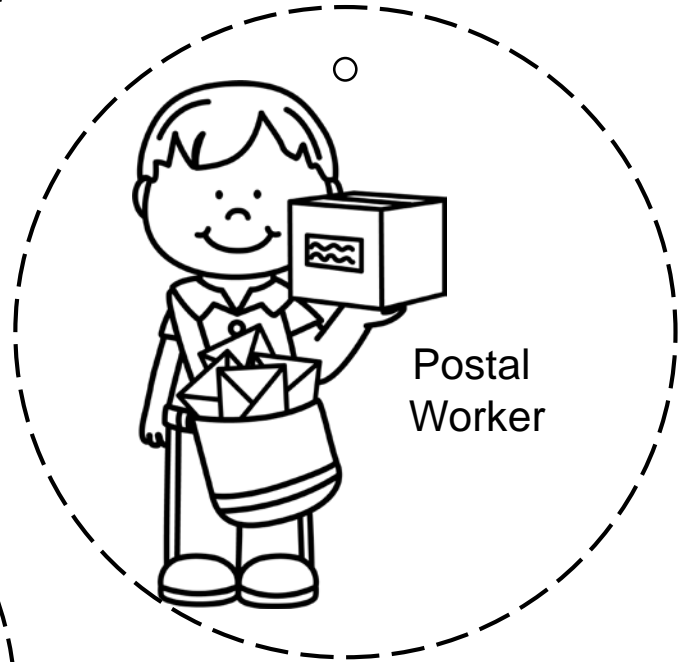

Community Helper Necklace

Teacher

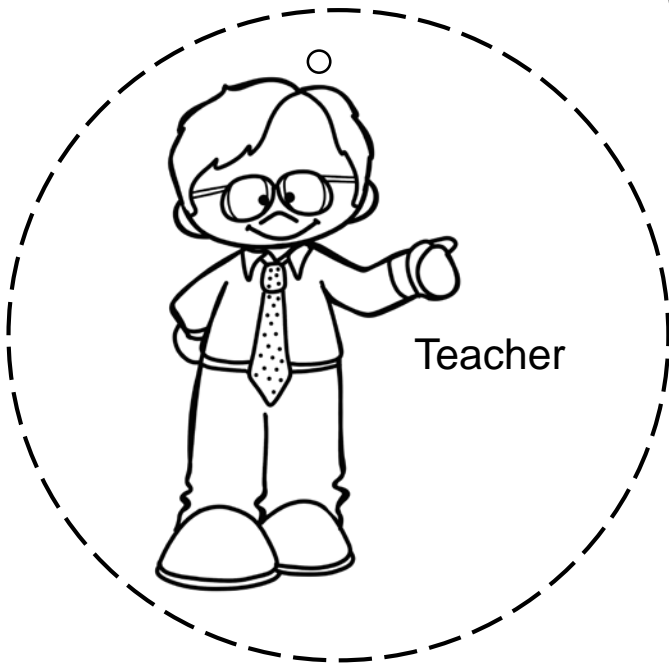
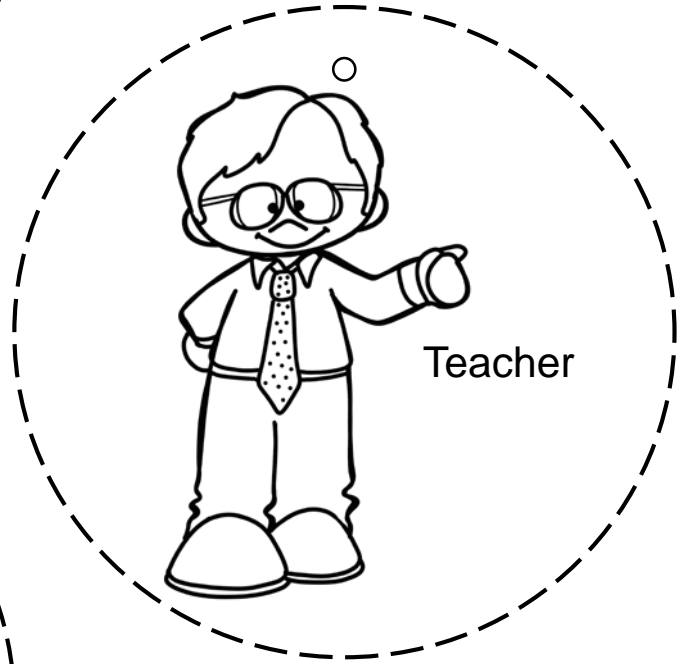
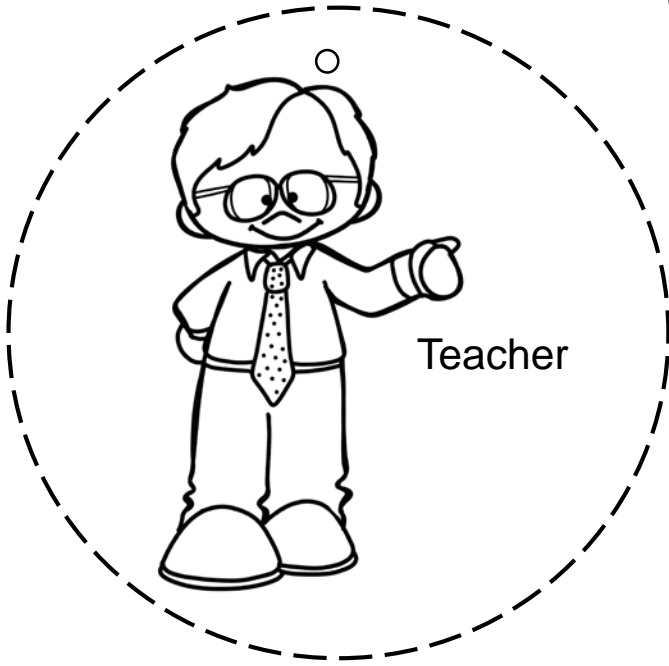
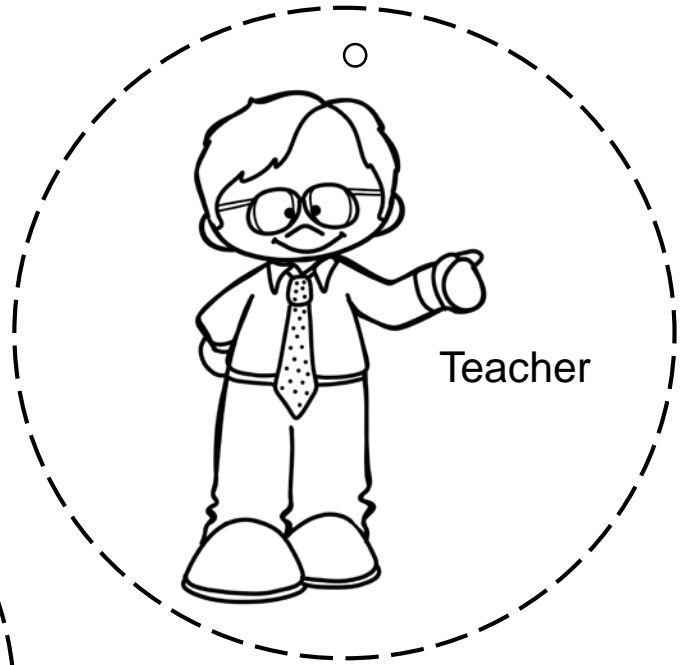

Community Helper Necklace

Child Care Provider

