



Down on the Farm

INFANT - TODDLER
PRESCHOOL
LESSON PLAN



ECIPs
(Early Childhood
Indicators of Progress)

By
123
Learn Curriculum





~Where Playing is Learning~

Contact information:

Jean Lang JeanieB506@gmail.com / JeanieB506@aol.com

Web site: <http://www.123learncurriculum.com>

Phone 651.468.6240

123 Learn Curriculum is designed to promote the physical, social-emotional, cognitive, and language development of children. Every child is a unique person with an individual pattern and timing of growth. We believe in respecting and responding to each child's learning preference.

Play is a young child's "work" as they touch, manipulate, and experiment with materials, explore and observe the environment, and interact with adults and one another. Children are also highly encouraged to initiate their own activities and learning. Piaget states that "children should be able to do their own experimenting and their own research. Teachers of course, can guide them by providing the appropriate materials, but the essential thing is that in order for a child to understand something, he must construct it himself, he must re-invent it.

Children learn best with repetition. Repetition is an essential key to the physical development of a child's brain. The more something is repeated the more likely children are to remember it. Repetition in a variety of forms also increases the likelihood of reaching children with different learning styles and provides a more comprehensive understanding of concepts.

123 Learn Curriculum provides this opportunity through fun themes such as dinosaurs and monsters. Each theme incorporates a letter, color, number and shape, and themes that provide hands on opportunities to make learning fun.

123 Learn Curriculum also understands the areas of child development and incorporates the Minnesota's Early Childhood Indicators of Progress into lesson plans. Letting providers know what domains are being touched on with each activity listed under infant, toddler and preschool daily plans.



~Where Playing is Learning~

What is 123 Learn Curriculum? 123 Learn Curriculum is a professionally planned preschool curriculum designed to be used in both family childcare homes and centers. This program offers the ease of printing up each day what you need and saving on waste. Money saving, this curriculum can be used over year after year.

What are the goals of 123 Learn Curriculum? 123 Learn Curriculum was developed by a childcare provider since 1985. The activities included are age appropriate and designed to help the whole child grow, and develop socially, physically and intellectually. Our program will help prepare each child for kindergarten, while opening the door for the children to be creative and express their artistic abilities.

123 Learn Curriculum grants permission to owners to print and modify these pages for their home and single classroom use only. These pages cannot be otherwise distributed or sold, in paper or digital format. Please do not share on e-mail lists or through websites. Please contact me if you have any questions.

Special thanks to all the graphic artists for their permission and license to display their graphics on the pages of 123 Learn Curriculum. Please check the graphic credit page to see what graphic sites have been used.

123 Learn Curriculum is suitable for children ages 2 to 5 but includes activities for infants and toddlers.

Jean

123 Learn Curriculum

JeanieB506@gmail.com / JeanieB506@aol.com

(651) 468.6240

THANK YOU for downloading this product. I hope you enjoy it as much as I did creating it! I value your feedback, so please don't hesitate to contact me if you have any questions. If you like this download, please let me know by leaving feedback for my online store. It helps not only me but other teachers that are looking for a good quality product.

Thank you again!

Jean JeanieB506@aol.com

Copyright © 2023 by Jean Lang - All rights reserved by author.

Purchase of this item or free download entitles the purchaser the right to product for personal and classroom use only. Posting this item in whole or in part on the Internet in any form is strictly prohibited and is a violation of the Digital Millennium Act (DMCA).

Please be fair and don't share!

CLICK TO CONNECT...



DOCUMENT CREATED BY:

JEAN LANG

123 LEARN CURRICULUM

GRAPHICS USED:

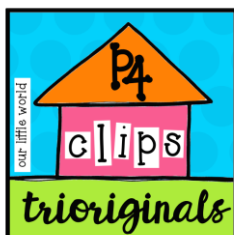

Hint on printing:

To save on ink - change your print quality on your printer to fast.

To do: Click print - properties - change print quality from standard to fast.

This will give you a lower quality page but will save on ink.



DOWN ON THE FARM

Lesson Plan

Infant - Toddler - Preschool



This section has the lesson plan for the Down on the Farm theme.

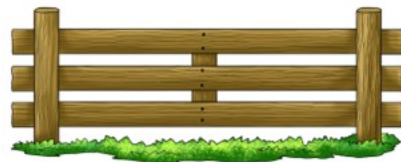

Pre-planned lesson plans are done using a specific book. Books are taken off the down on the farm book list and can easily be found in your local library or store. You can also use a different book to go with this theme.

All sheets are in order and labeled for each day the sheets are to be used. Print up the number of sheets you need each day. Worksheets are theme related and also include the letter Y, number 4, shape triangle, and color pink.

Print up sheets on regular copy paper. For better durability, use card stock. Don't be limited by your imagination!

Use markers, colored pencils, paint, paint daubers, etc. Don't stick to just crayons. 😊

Down on the Farm



Letter: Y

Number: 4

Shape: Triangle

Color: Pink



<http://123learncurriculum.com/>

Refer all inquires to:

Jean –

JeanieB506@gmail.com

JeanieB506@aol.com

651.468.6240



Down on the
Farm





~Where Playing is Learning~

123 Learn Curriculum grants permission to owners to print and modify these pages for their home and single classroom use only. These pages cannot be otherwise distributed or sold, in paper or digital format. Please do not share on e-mail lists or through websites. Please contact me if you have any questions.

Special thanks to all the graphic artists for their permission and license to display their graphics on the pages of 123 Learn Curriculum. Please check graphics used page for logos.

123 Learn Curriculum is suitable for children ages 2 to 5.

<http://123learncurriculum.com>

Refer all inquires to:

Jean – JeanieB506@gmail.com

JeanieB506@aol.com

651.468.6240



~Where Playing is Learning~

If Down on the Farm is your first themed curriculum you are using from 123 Learn Curriculum, please print up the following letter to hand out to parents.

This will let them know of the new curriculum you're using in your childcare / preschool.

Please note: On the following page you have the option of typing your name directly onto the letter. Type in the blue box and print.

Blue box will not print.

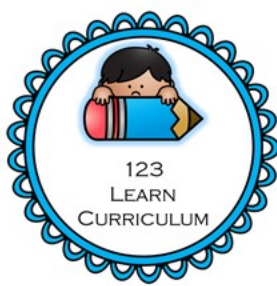

~Where Playing is Learning~

Dear Parents,

We are using a new preschool program this year called 123 Learn Curriculum. Each week will be weekly, bi-weekly or monthly theme.

Themes that your children will enjoy like: Outer Space, Dinosaurs, Monsters and the current theme we're working on now Down on the Farm.

Some of these projects will be taken home to share with you and others will be group activities that you can ask about. I think that both you and your child will enjoy this new program as much as I will.

Please make sure you spend time looking at what your children do each week. They are so proud of what they do!

Thank you



How to Read the ECIPs

The organization of the domains is designed to be easy-to-understand and aid in planning by teachers for individuals and small groups of children. The ECIPs are now displayed as an age continuum within each domain and include the following elements:

- DOMAINS are major areas of development.
- COMPONENTS are specific areas of learning within each domain.
- SUBCOMPONENTS are consistent strands within a component across the full age-range continuum.
- INDICATORS are expectations for observable outcomes for the child at specific ages. For quick reference, indicators are now numbered within the domain and subcomponent.
- INDICATOR NUMBERS identify the location of an indicator within the domain, component and subcomponent.

The learning domains included in the ECIPs are:

1. Social and Emotional Development
2. Approaches to Learning
3. Language, Literacy and Communications
4. The Arts
5. Social Systems: Cognitive
6. Physical and Movement Development
7. Mathematics
8. Scientific Thinking

There are five age ranges identified, one for each year of a child's life from birth to kindergarten entry. The age ranges in the new ECIPs are:

- 0-1 year
- 1-2 years
- 2-3 years
- 3-4 years
- 4-5, K-readiness

Note: In the Language, Literacy and Communications domain, the first two age ranges are slightly different than in the other domains. This is because of the large amount of research that highlighted these age ranges as important in language development.

Remember, children's development is highly variable. Children will not always demonstrate indicators identified for their chronological age. They may show some behaviors identified for younger children or may demonstrate some skills and knowledge beyond their present age. The ECIPs are formatted in a continuum across different age ranges so that teachers and providers can identify where each child is performing and easily see what the next expectation is in the continuum. They can also see the indicator(s) in a previous age range, which can guide teachers to plan for missed or needed experiences and adapt curricula accordingly.

To view pdf files of each ECIP, please click on the link below.

http://ceed.umn.edu/wp-content/uploads/2017/05/Early-childhood-indicators-of-progress_Preschool.pdf

When putting together Down on the Farm, the following pages show you an example to binding the infant lesson plan.

You can put into the lesson plan the pages you want. Sample shows cover sheet printed on photo quality paper, and a transparent binding cover. Additional sheets are printed on copy paper 24 lb. You can find items at your local office supply store or purchase directly from Amazon. Click on picture to purchase from Amazon.



Transparent Binding Covers

You can also print up cover on card stock. Printing on photo quality paper will give you a more vibrant color.

Copy Paper 24 lb

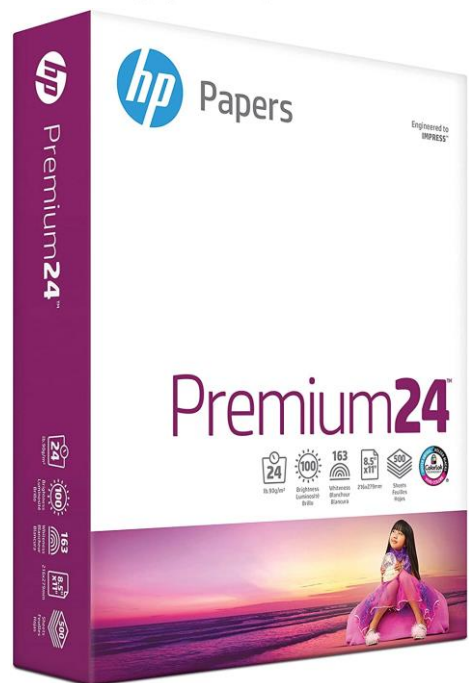

You can bound lesson plan using a binding machine that use coils or combs. Sample shows using coils. You can have this done at a local office supply store or purchase your own to use.

On the following page there are 2 samples of comb or coiled machine you can purchase directly from Amazon or go onto their search bar and type in binding machine.

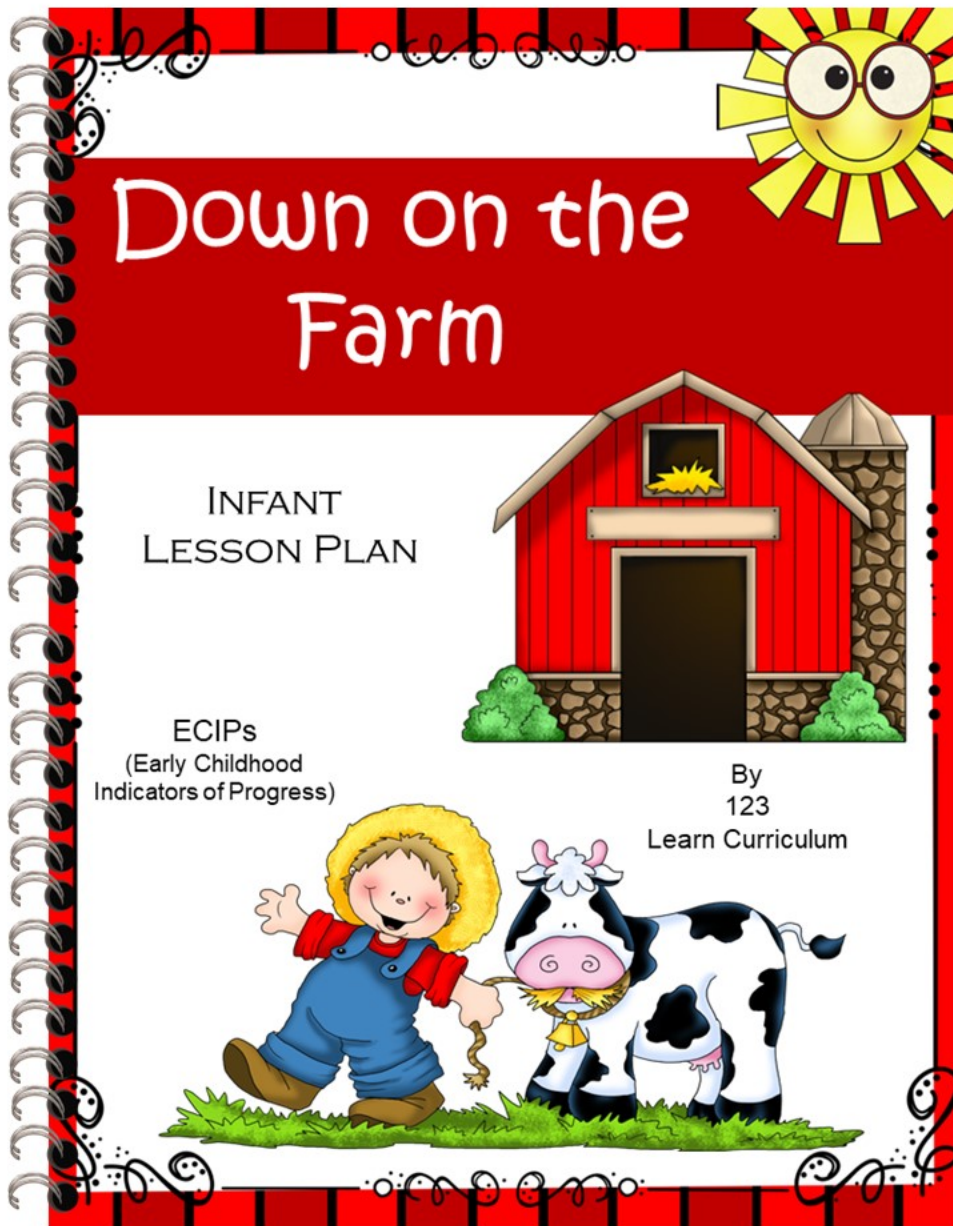

Comb machine
using combs
pictured below.



Coil machine
using coils
pictured below.



Social and Emotional Development Infants / Toddlers

Domain 1:

Social and Emotional Development

- Trust & Emotional Security
- Self-Awareness
- Relationship with Other Children



Social and Emotional Development ideas. These ideas can be done daily.

- Self-Regulation Greet all children each morning by name and smile.
- During the day take time to hold on lap, and read a book or 2 from the current theme book list.
- When talking with children, make eye contact. Look right into their eyes. When talking encourage them to coo or talk back.
- Talk with children as you go about your day. Tell them what you are doing, what you see. Point things out to them.
- Talk with children, pay attention to their feelings and listen to their coos and words.
- Gently hold and give hugs often.
- Enrich children's daily routines such as mealtime, naps, etc., by sharing looks, smiles, conversations, and stories.
- Attentively respond to children's attempts to communicate with you through facial expressions, gestures, cooing, babbling, and words. Gently mirror their sounds and expressions.
- Take time to follow a child's lead. Join them in floor-time play, and talk with them about their activities whenever possible.
- Gently guide children through social situations: Babies love to look at other babies. Toddlers and preschoolers learn to socialize through practice and experiences that are supported by caring adults.
- Be a positive role model: Offer children opportunities to observe you being a kind and caring person.
- Help children learn a variety of words to fully express their feelings.
- Comment on the positive things that children do.

Group Planning Form

Teacher(s)

Group: Infants

Week of:

Theme: Down on the Farm

Changes to Environment: Print up down on the farm posters located in the infant lesson plan. Laminate pictures so that they can be used year after year. Hang pictures down low where infants can view. Sit on the floor with infants and talk about the pictures.

Changes to Routines and Schedule: Add any farm related items around the playroom for infants. Have board books, theme related for sitting and reading each day. Infants LOVE to look at pictures, so make them available.

Family / Home Connection: Send home themed letter Friday before your down on the farm theme begins. Post on bulletin board cover sheet so parents have a visual what the theme is for next week

Story Time: Farm Peekaboo! By DK Publishing

Moving to Music: Lucky Duck

Sign Language: Cow to sign cow, make your hand into a fist and then straighten your pinkie finger and straighten your thumb. The two extended fingers on your hand should look like the horns of a cow. Take your thumb and put it by the side of your head and twist your hand around. Video: [Cow](#)

TO DO LIST:

Buy: Items needed for infant area. Additional books, any farm toys, rattles, etc., that you want to have available for infants. Store in bin for next year's down on the farm theme.

Gather: Any additional supplies for theme.

Other: Go to your local library and get additional books about farms and farm animals. Check the down on the farm list included with this lesson plan. Take time each day to read a book from the farm books you have.



Lucky Duck

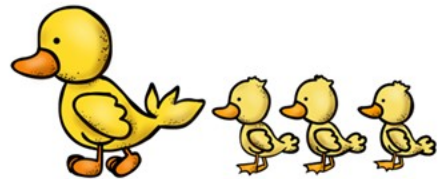

Oh, it was a bit of luck.
That I was born a baby duck.
With yellow socks and yellow shoes.
That I may go wherever I choose!
Quack, quack, quack, quack.

Monday – Friday

Every morning – greet children by name and with a smile. Have eye contact and show children that you are happy to see them each morning.

Domain: Social and Emotional Development
Component: S6-8: Social Understanding and Relationships
Subcomponent: S6 Social Responsiveness:
 Child notices and responds to others and their emotions

- S6.1** Shows interest or reacts to others' emotions
- S6.2** Responds to others' emotional tone and actions



Monday – Friday

Everyday sing or play music for children. You might not have the greatest voice, but children can connect, bond and this is a fun way to interact with all children.

Domain: The Arts
Component: A1-2: Exploring the Arts
Subcomponent: A1
 Children shows an interest in learning about different artistic experiences

- A1.1** Actively explores their environment (through song, music, movement, etc.) to enrich their senses.



Spend time reading to children every day. Reading to children set the foundation for later independent reading. Benefits include boosting school readiness - reading is one of the easiest ways to increase school readiness. When you read to children, you're helping to build their vocabulary, language and literacy skills, while improving concentration, curiosity and memory. Research shows that the more words a child is exposed to, the better prepared they are to eventually start reading on their own.

Domain: Language Literacy Communications
Component: LLC 5-13: Emergent Reading
Subcomponent: L4 Motivation, Engagement:
 Child has an interest in and sustained attention for literacy acts

Birth to 5 months:

- L4.1** Likes to be read to and shown pictures
- L4.2** Makes sounds while looking at text or images

6 – 15 months:

- L4.2** Makes sounds while looking at text or images
- L4.3** Points to a few pictures in books and in response to adult question
- L4.4** Demonstrates interest and involvement with books and other print materials

As you spend each day singing to the children, they are benefiting in so many ways. Having a special song for waking up, and other routine transitions and activities helps them know what comes next.

Language – through your singing, you are introducing a whole new vocabulary. Rhyming songs – children in time will recognize rhymes. Listening skills – like reading, singing is an activity that requires listening. There are so many benefits that you just might want to grab that Mic and go for it. ☺

Domain: Language, Literacy and Communications
Component: LLC 1-2: Listening and Understanding; Receptive Language
Subcomponent: L1 Language Comprehension:
 Child understands the meaning of words and phrases (receptive) and uses those words and phrases to communicate effectively (expressive)

- L1.1** Turns toward and focuses on nearby adult caregiver who is speaking
- L1.2** Watches caregiver actions and gestures



Teacher(s) _____ Week of: _____

Group: Infant Theme: Down on the Farm

123 Learn Curriculum	Monday
Social Emotional	Activity: Self-Regulation. Greet all children each morning by name and smile. Component: Social Understanding and Relationships – S7 Building relationships
Approaches to Learning	Activity: Spaghetti Sensory Play Component: Initiative and Curiosity – AL1 Inquisitiveness
Language Literacy Communications	Activity: Reading Daily – Dinosaur's Binkit – Plus other assorted theme related infant books. Component: Emergent Reading – L4 Motivation, engagement
The Arts	Activity: Singing or music playing daily Component: Exploring the Arts – A1
Social Systems Cognitive	Activity: Component:
Physical & Movement	Activity: Baby Farm Animal Component: P5.1: Fine Motor
Mathematics Cognitive	Activity: Component:
Scientific Thinking Cognitive	Activity: Component:

Theme: Down on the Farm – Infant Activities

Monday

Spaghetti Sensory Play
 Ages 6 months – 12 months
 Activity for 1 infant
 Duration of activity: 5 – 10 minutes

Skill activity supports: Sensory play can be therapeutic and calming for children. This sensory idea can work into your Down on the Farm theme. Do this activity with older infants.

Domain: Physical and Movement Development
Component: Fine Motor
Subcomponent: P5 Dexterity Child can coordinate and control movement of hands and fingers to grasp and manipulate objects.
P5.1 Reaches for toy, grasp it and releases

Domain: Approaches to Learning
Component: AL1-2 Initiative and Curiosity
Subcomponent: AL1 Inquisitiveness
 Child explores the environment and seeks interaction with people and objects; willingly tries new things
AL1.1 Shows interest in the environment primarily through looking and listening

Domain: Social and Emotional Development
Component: S6-8: Social Understanding and Relationships
Subcomponent: S7 Building Relationships
 Child establishes and sustains relationships with others
S7.1 Shows a preference for a trusted adult
S7.2 Notices or responds to others

- Materials needed:
- Plastic farm animals 2 – 3
 - Spaghetti noodles – prepared ahead of time
 - Pail or bin

Cook spaghetti noodles and cool. Once cool, place some of the noodles into a large baggie with green food coloring. Shake and mix so color is added to all pasta. After 5-15 minutes of play throw the noodles away, rinse off the farm animals and place in a small basket and place on a shelf for all the children to play with. (Directions follow).

Print the following cover
on white card stock.



Down on the Farm

INFANT LESSON PLAN



ECIPs
(Early Childhood
Indicators of Progress)

By
123
Learn Curriculum



Social and Emotional Development

Infants / Toddlers

Domain 1:

Social and Emotional Development

- Trust & Emotional Security
- Self-Awareness
- Relationship with Other Children



Social and Emotional Development ideas. These ideas can be done daily.

- Self-Regulation Greet all children each morning by name and smile.
- During the day take time to hold on lap, and read a book or 2 from the current theme book list.
- When talking with children, make eye contact. Look right into their eyes. When talking encourage them to coo or talk back.
- Talk with children as you go about your day. Tell them what you are doing, what you see. Point things out to them.
- Talk with children, pay attention to their feelings and listen to their coos and words.
- Gently hold and give hugs often.
- Enrich children's daily routines such as mealtime, naps, etc., by sharing looks, smiles, conversations, and stories.
- Attentively respond to children's attempts to communicate with you through facial expressions, gestures, cooing, babbling, and words. Gently mirror their sounds and expressions.
- Take time to follow a child's lead. Join them in floor-time play, and talk with them about their activities whenever possible.
- Gently guide children through social situations: Babies love to look at other babies. Toddlers and preschoolers learn to socialize through practice and experiences that are supported by caring adults.
- Be a positive role model: Offer children opportunities to observe you being a kind and caring person.
- Help children learn a variety of words to fully express their feelings.
- Comment on the positive things that children do.

Blank Weekly Infant Lesson Plan

Print up and fill out if you want to do your own lesson plan.

Teacher (s) _____

Week of: _____

Group: Infant

Theme: Down on the Farm

123 Learn Curriculum	Monday	Tuesday	Wednesday	Thursday	Friday
Social Emotional	Activity:	Activity:	Activity:	Activity:	Activity:
	Component:	Component:	Component:	Component:	Component:
Approaches to Learning	Activity:	Activity:	Activity:	Activity:	Activity:
	Component:	Component:	Component:	Component:	Component:
Language Literacy Communications	Activity:	Activity:	Activity:	Activity:	Activity:
	Component:	Component:	Component:	Component:	Component:
The Arts	Activity:	Activity:	Activity:	Activity:	Activity:
	Component:	Component:	Component:	Component:	Component:
Social Systems Cognitive	Activity:	Activity:	Activity:	Activity:	Activity:
	Component:	Component:	Component:	Component:	Component:
Physical & Movement	Activity:	Activity:	Activity:	Activity:	Activity:
	Component:	Component:	Component:	Component:	Component:
Mathematics Cognitive	Activity:	Activity:	Activity:	Activity:	Activity:
	Component:	Component:	Component:	Component:	Component:
Scientific Thinking Cognitive	Activity:	Activity:	Activity:	Activity:	Activity:
	Component:	Component:	Component:	Component:	Component:

Teacher (s) _____

Week of: _____

Group: Infant

Theme: Down on the Farm

	Monday	Tuesday	Wednesday	Thursday	Friday
123 Learn Curriculum					
Social Emotional	Activity: Greet all children each morning by name and smile.	Activity: Talk to children as you go about your day. Tell them what you are doing, what you see. Point things out to them.	Activity: When talking with children, make eye contact. Look right into their eyes. When talking encourage them to coo or talk back.	Activity: Be a positive role model: Offer children opportunities to observe you being a kind and caring person.	Activity: Help children learn a variety of words to fully express their feelings.
	Component: S 6-8: Social Understanding and Relationships	Component: S 6-8: Social Understanding and Relationships	Component: S 6-8: Social Understanding and Relationships	Component: S 6-8: Social Understanding and Relationships	Component: S 6-8: Social Understanding and Relationships
Approaches to Learning	Activity: Spaghetti Sensory Play	Activity: Farm Animal Sensory Bag	Activity: Whisk Play	Activity: Making Noise	Activity: Hold 2 Things
	Component: AL1 Inquisitiveness	Component: AL10-13 Processing and Utilizing Info.	Component: AL1 Initiative and Curiosity	Component: AL-1 Initiative and Curiosity	Component: AL1 – Initiative and Curiosity
Language Literacy Communications	Activity: Reading Daily – Farm Peekaboo – Plus other books.	—————→			
	Component: LLC 5-13: Emergent Reading	Component: LLC 5-13: Emergent Reading	Component: LLC 5-13: Emergent Reading	Component: LLC 5-13: Emergent Reading	Component: LLC 5-13: Emergent Reading
The Arts	Activity: Singing or music daily	—————→			
	Component: A1-2: Exploring the Arts	Component: A1-2: Exploring the Arts	Component: A1-2: Exploring the Arts	Component: A1-2: Exploring the Arts	Component: A1-2: Exploring the Arts
Social Systems Cognitive	Activity:	Activity:	Activity:	Activity:	Activity:
	Component:	Component:	Component:	Component:	Component:
Physical & Movement	Activity: Baby Farm Animals	Activity: Farm Painting	Activity: Touch and Tell	Activity: Sticky Farm Animals	Activity: Tape Pull
	Component: P5-6: Fine Motor	Component: P5-6: Fine Motor	Component: P5-6 Fine Motor	Component: P5-6: Fine Motor	Component: P5-6 Fine Motor
Mathematics Cognitive	Activity:	Activity:	Activity:	Activity:	Activity:
	Component:	Component:	Component:	Component:	Component:
Scientific Thinking Cognitive	Activity:	Activity:	Activity:	Activity:	Activity:
	Component:	Component:	Component:	Component:	Component:

Group Planning Form

Teacher(s)

Group: Infants

Week of:

Theme: Down on the Farm

Changes to Environment: Print up down on the farm posters located in the infant lesson plan. Laminate pictures so that they can be used year after year. Hang pictures down low where infants can view. Sit on the floor with infants and talk about the pictures.

Changes to Routines and Schedule: Add any farm related items around the playroom for infants. Have board books, theme related for sitting and reading each day. Infants LOVE to look at pictures, so make them available.

Family / Home Connection: Send home themed letter Friday before your down on the farm theme begins. Post on bulletin board cover sheet so parents have a visual what the theme is for next week

Story Time: Farm Peekaboo! By DK Publishing

Moving to Music: Lucky Duck

Sign Language: Cow to sign cow, make your hand into a fist and then straighten your pinkie finger and straighten your thumb. The two extended fingers on your hand should look like the horns of a cow. Take your thumb and put it by the side of your head and twist your hand around. Video: [Cow](#)

TO DO LIST:

Buy: Items needed for infant area. Additional books, any farm toys, rattles, etc., that you want to have available for infants. Store in bin for next year's down on the farm theme.

Gather: Any additional supplies for theme.

Other: Go to your local library and get additional books about farms and farm animals. Check the down on the farm list included with this lesson plan. Take time each day to read a book from the farm books you have.



Infant Book Choice

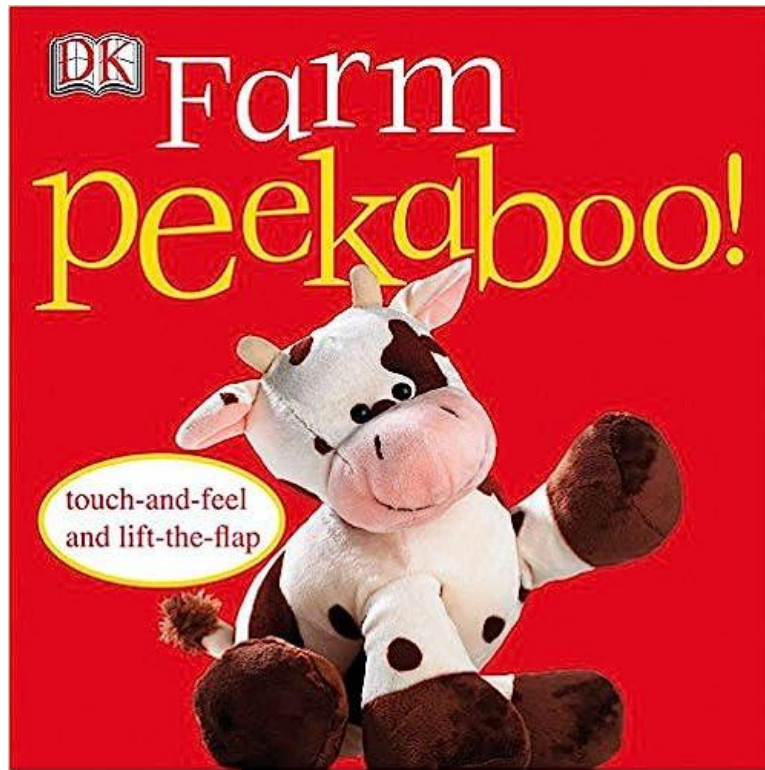

Farm Peekaboo! By DK

Click on picture above to go to Amazon.com to purchase book.

Once you click on book, click on allow and you will be taken directly to the book to purchase.

You can also check your local library to see if they have a copy.

Lucky Duck

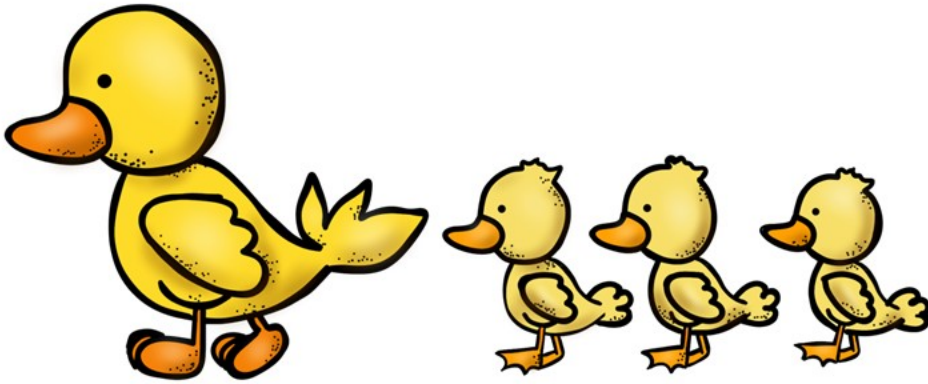

Oh, it was a bit of luck.
That I was born a baby duck.
With yellow socks and yellow shoes.
That I may go wherever I choose!
Quack, quack, quack, quack.

Cow sign language poster used with permission from
Baby Sign Language.

To purchase any sign language materials, please visit
Baby Sign Language @
<https://www.babysignlanguage.com/>

To view video for signing gift,
click on the link below:
<https://www.babysignlanguage.com/dictionary/c/cow/>

Cow



Signing: To make the sign for cow, make your hand into a fist then straighten your pinkie finger and straighten your thumb. The two extended fingers on your hand should look like the horns of a cow. Take your thumb and put it by the side of your head and twist your hand around.

Monday – Friday

Every morning – greet children by name and with a smile. Have eye contact and show children that you are happy to see them each morning.

Domain: Social and Emotional Development
Component: S6-8: Social Understanding and Relationships

Subcomponent: S6 Social Responsiveness:

Child notices and responds to others and their emotions

S6.1 Shows interest or reacts to others' emotions

S6.2 Responds to others' emotional tone and actions



Spend time reading to children every day. Reading to children sets the foundation for later independent reading. Benefits include boosting school readiness - reading is one of the easiest ways to increase school readiness. When you read to children, you're helping to build their vocabulary, language and literacy skills, while improving concentration, curiosity and memory. Research shows that the more words a child is exposed to, the better prepared they are to eventually start reading on their own.

Domain: Language Literacy Communications

Component: LLC 5-13: Emergent Reading

Subcomponent: L4 Motivation, Engagement:

Child has an interest in and sustained attention for literacy acts

Birth to 5 months:

L4.1 Likes to be read to and shown pictures

L4.2 Makes sounds while looking at text or images

6 – 15 months:

L4.2 Makes sounds while looking at text or images

L4.3 Points to a few pictures in books and in response to adult question

L4.4 Demonstrates interest and involvement with books and other print materials

Monday – Friday

Everyday sing or play music for children. You might not have the greatest voice, but children can connect, bond and this is a fun way to interact with all children.

Domain: The Arts

Component: A1-2: Exploring the Arts

Subcomponent: A1

Children shows an interest in learning about different artistic experiences

A1.1 Actively explores their environment (through song, music, movement, etc.) to enrich their senses.



As you spend each day singing to the children, they are benefiting in so many ways. Having a special song for waking up, and other routine transitions and activities helps them know what comes next.

Language – through your singing, you are introducing a whole new vocabulary. Rhyming songs – children in time will recognize rhymes. Listening skills – like reading, singing is an activity that requires listening. There are so many benefits that you just might want to grab that Mic and go for it. 😊

Domain: Language, Literacy and Communications

Component: LLC 1-2: Listening and Understanding; Receptive Language

Subcomponent: L1 Language Comprehension:

Child understands the meaning of words and phrases (receptive) and uses those words and phrases to communicate effectively (expressive)

L1.1 Turns toward and focuses on nearby adult caregiver who is speaking

L1.2 Watches caregiver actions and gestures



Teacher (s) _____ Week of: _____

Group: Infant

Theme: Down on the Farm

123 Learn Curriculum	Monday
Social Emotional	Activity: Self-Regulation. Greet all children each morning by name and smile.
	Component: Social Understanding and Relationships – S7 Building relationships
Approaches to Learning	Activity: Spaghetti Sensory Play
	Component: Initiative and Curiosity – AL1 Inquisitiveness
Language Literacy Communications	Activity: Reading Daily – Farm Peekaboo! By DK Publishing– Plus other assorted theme related infant books.
	Component: Emergent Reading – L4 Motivation, engagement
The Arts	Activity: Singing or music playing daily
	Component: Exploring the Arts – A1
Social Systems Cognitive	Activity:
	Component:
Physical & Movement	Activity: Baby Farm Animals
	Component: P5.1: Fine Motor
Mathematics Cognitive	Activity:
	Component:
Scientific Thinking Cognitive	Activity:
	Component:

Monday

Spaghetti Sensory Play

Ages 6 months – 12 months

Activity for 1 infant

Duration of activity: 5 – 15 minutes

Skill activity supports: Sensory play can be therapeutic and calming for children. This sensory idea can work into your Down on the Farm theme. Do this activity with older infants.

Domain: Physical and Movement Development

Component: Fine Motor

Subcomponent: P5 Dexterity Child can coordinate and control movement of hands and fingers to grasp and manipulate objects.

P5.1 Reaches for toy, grasp it and releases

Domain: Approaches to Learning

Component: AL1-2 Initiative and Curiosity

Subcomponent: AL1 Inquisitiveness

Child explores the environment and seeks interaction with people and objects; willingly tries new things

AL1.1 Shows interest in the environment primarily through looking and listening

Domain: Social and Emotional Development

Component: S6-8: Social Understanding and Relationships

Subcomponent: S7 Building Relationships

Child establishes and sustains relationships with others

S7.1 Shows a preference for a trusted adult

S7.2 Notices or responds to others

Materials needed:

- Plastic farm animals 2 - 3
- Spaghetti noodles – prepared ahead of time
- Pail or bin

Cook spaghetti noodles and cool. Once cool, place some of the noodles into a large baggie with green food coloring. Shake and mix so color is added to all pasta. After 5 – 15 minutes of play, throw the noodles away, rinse off the farm animals and place in a small basket and place on a shelf for all the children to play with. (Directions follow).

Monday

Spaghetti Sensory Play

Ages 6 months – 12 months

Activity for 1 infant

Duration of activity: 5 – 15 minutes

Sit infant in the highchair and offer them a few strands of spaghetti on the tray as a first introduction to the new material. You can then take a small pail, bin or tray, place a few noodles and add a couple plastic farm animals and then add more noodles on top. Let infants dig in the pail and find the farm animals.

Messy play is about communication. Talk with infant as she is discovering each new animal. Soft, wiggly, names of the animals she found. Although infants are not yet talking and using words, you are helping them to build up a rich vocabulary.

NEVER leave infants alone with the spaghetti. This is a fun activity for them to explore. And after 5 – 15 minutes, throw the noodles away, rinse off the farm animals, place in a small basket and place on a shelf for all the children to play with.

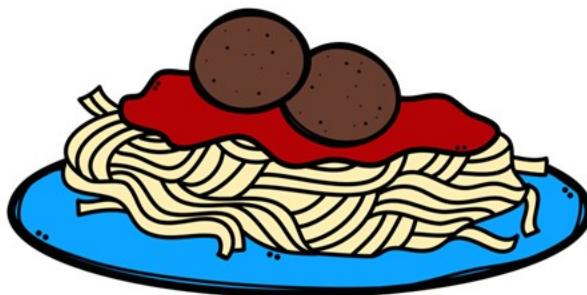

Monday

Baby Farm Animals

Ages 3 months – 12 months

Activity for 1 2 infants

Duration of activity: 5 - 10 minutes

Skill activity supports social and emotional development, cognitive development and small Motor

Domain: Social and Emotional Development

Component: S6-8: Social Understanding and Relationships

Subcomponent: S7 Building Relationships

Child establishes and sustains relationships with others

S7.1 Shows a preference for a trusted adult

S7.2 Notices or responds to others

Domain: Physical and Movement Development

Component: Fine Motor

Subcomponent: P5 Dexterity Child can coordinate and control movement of hands and

fingers to grasp and manipulate objects.

P5.1 Reaches for toy, grasp it and releases

Materials needed:

- Farm animals – stuffed or plastic
- Basket

Get down on the floor with the infant and have a basket of stuffed farm animals or plastic farm animals. If the infant is not old enough to sit on their own, have them sit in a bouncy seat, otherwise let them sit on your lap. Show them the basket of animals and have them reach in and pick out the animals. Let them know what they have chosen and make the animal sound.

You are building on this activity to what was done this morning with the spaghetti but no mess.

Teacher (s) _____ Week of: _____

Group: Infant

Theme: Down on the Farm

123 Learn Curriculum	Tuesday
Social Emotional	Activity: Talk to children as you go about your day. Tell them what you are doing, what you see. Point things out to them.
	Component: Social Understanding and Relationships – S7 Building relationships
Approaches to Learning	Activity: Farm Animal Sensory Bag
	Component: AL10-13 Processing and Utilizing Information
Language Literacy Communications	Activity: Reading Daily – Farm Peekaboo! By DK Publishing– Plus other assorted theme related infant books.
	Component: Emergent Reading – L4 Motivation, engagement
The Arts	Activity: Singing or music playing daily
	Component: Exploring the Arts – A1
Social Systems Cognitive	Activity:
	Component:
Physical & Movement	Activity: Farm Painting
	Component: P5-6: Fine Motor
Mathematics Cognitive	Activity:
	Component:
Scientific Thinking Cognitive	Activity:
	Component:

Tuesday

Farm Animal Sensory Bag

Activity for 1 infant

Duration of activity: 5 - 10 minutes

Skill activity supports social and emotional development, cognitive development and fine motor

Domain: Approaches to Learning

Component: AL10-13 Processing and Utilizing Information

Subcomponent: AL10 Working Memory

Child stores and retrieves information in order to use it purposefully

AL10.1 Demonstrates understanding of object permanence

Domain: Social and Emotional Development

Component: S6-8: Social Understanding and Relationships

Subcomponent: S7 Building Relationships

Child establishes and sustains relationships with others

S7.1 Shows a preference for a trusted adult

S7.2 Notices or responds to others

Domain: Physical and Movement Development

Component: Fine Motor

Subcomponent: P5 Dexterity Child can coordinate and control movement of hands and fingers to grasp and manipulate objects.

P5.1 Reaches for toy, grasp it and releases

Materials needed:

- Large Ziplock baggie
- Farm puzzle pieces
- Bird seed, black beans, or dry corn
- Duct tape



Tuesday

Farm Animal Sensory Bag

Activity for 1 infant

Duration of activity: 5 - 10 minutes

Take a large Ziploc bag and fill halfway with your choice of bird seed, black beans or corn.

Next add farm puzzle pieces to the bag. Make sure to use flat puzzle pieces for easier movement. You will then seal bag while removing all the air and lay it flat. You want to make sure you have added enough of the seeds, etc. to cover all the puzzle pieces. If you need more filler, add before you seal completely. Once you have the right amount of filler, zip the top of the bag and then secure the top of the bag with duct tape.

Lay the bag flat on the floor and make sure all puzzle pieces are covered completely.

Have infant play with the bag, uncovering the animals as they pick up the bag, and moving the filler inside the bag to expose the puzzle pieces. Let the infant know what animal they see and what sound it makes.

This activity is also fun for toddlers, where they will be able to use their fingers more by moving the filler inside the bag.



Sample of bird seed available on Amazon.

Click on picture to purchase from Amazon, or check your local Menards, Home Depot, etc.

I receive no compensation for promoting Amazon.

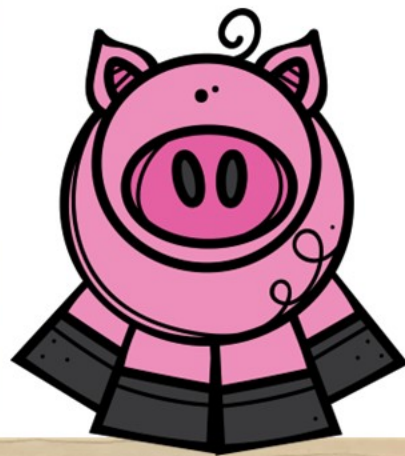

Sample of
farm
sensory bag

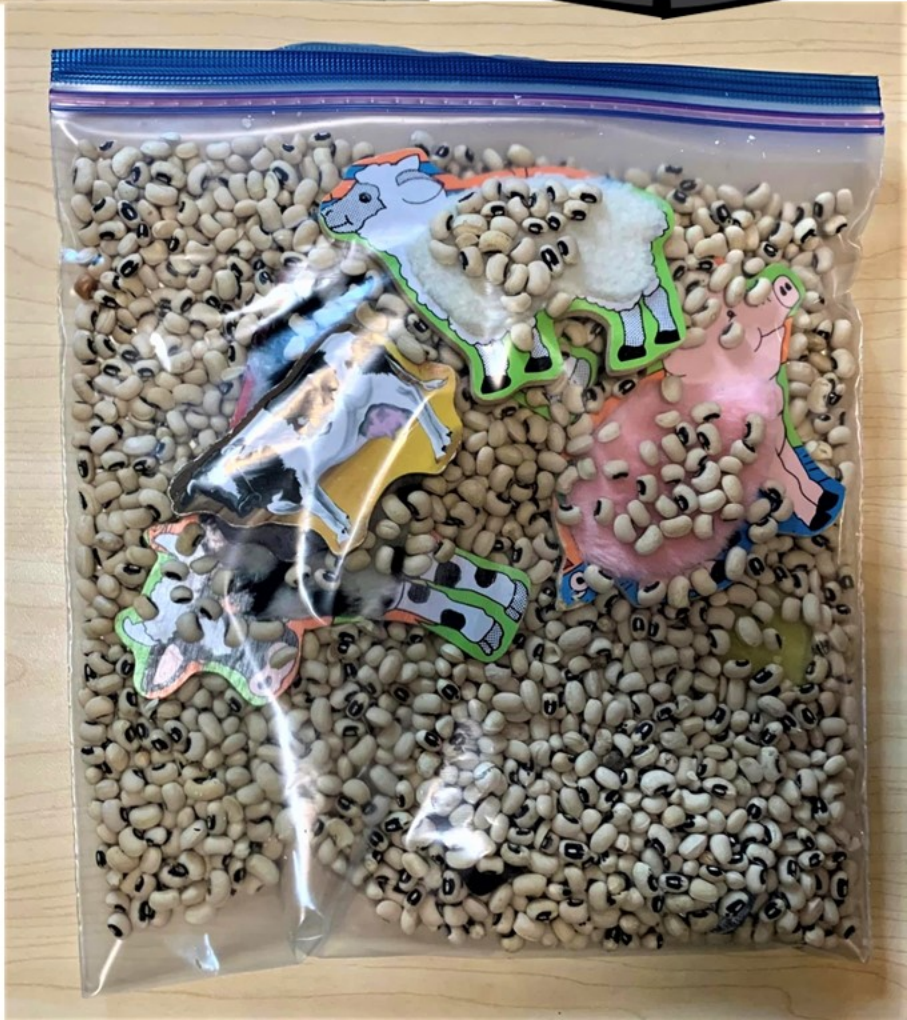

Tuesday

Down on the Farm Painting Activity for 1 or more infant

Duration of activity: 5 - 10 minutes

Print farm pictures on white card stock. Trim and place in a large baggie. Squirt several colors of paint into the baggie. Zip lock the baggie closed getting out as much air as you can. Tape the baggie to the floor using the masking or painter's tape. (Around all 4 sides of the baggie). Lay the infant on the floor near the baggie. A fun / colorful way to spend some tummy time. Take the infant's hand and show them that they can push their hand on the baggie and the paint will spread. Talk to the infant about the colors they are "painting" with.

A fun, clean way for the infants to create a beautiful piece of artwork. NEVER leave the infant alone on the floor with the baggie.

Once the infant is done with tummy time and painting, open the baggie and pull out the piece of paper. Let the page dry. Label on the back with the child's name and date.

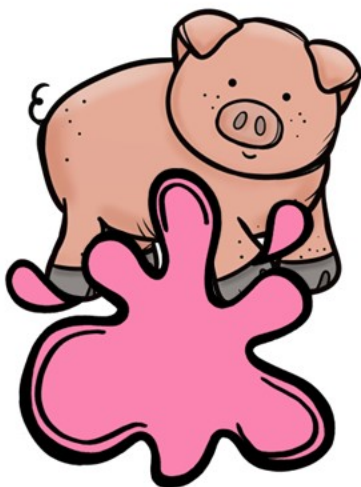

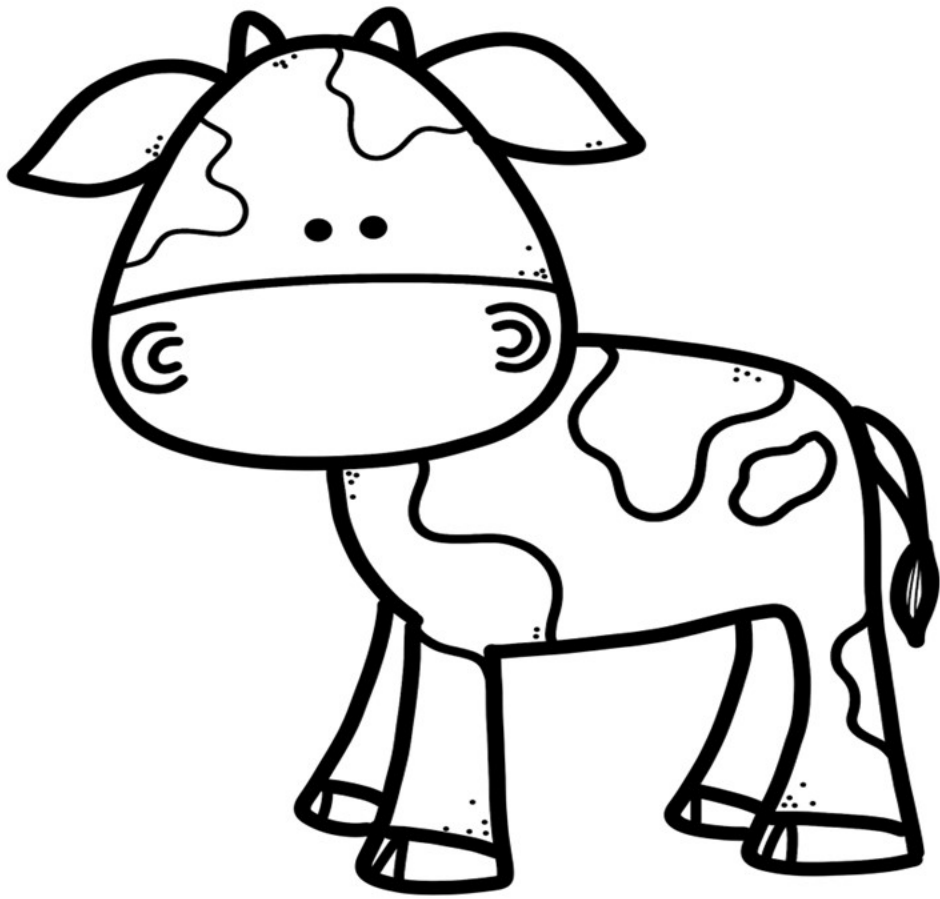

123 Learn Curriculum

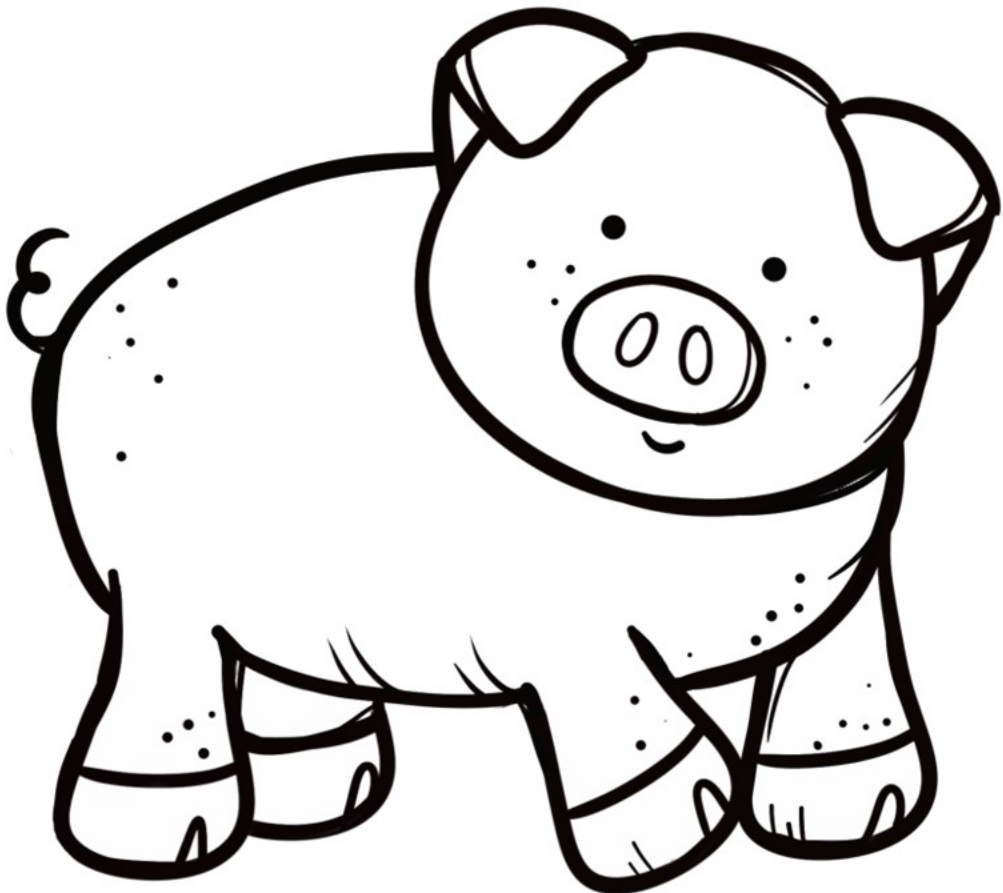

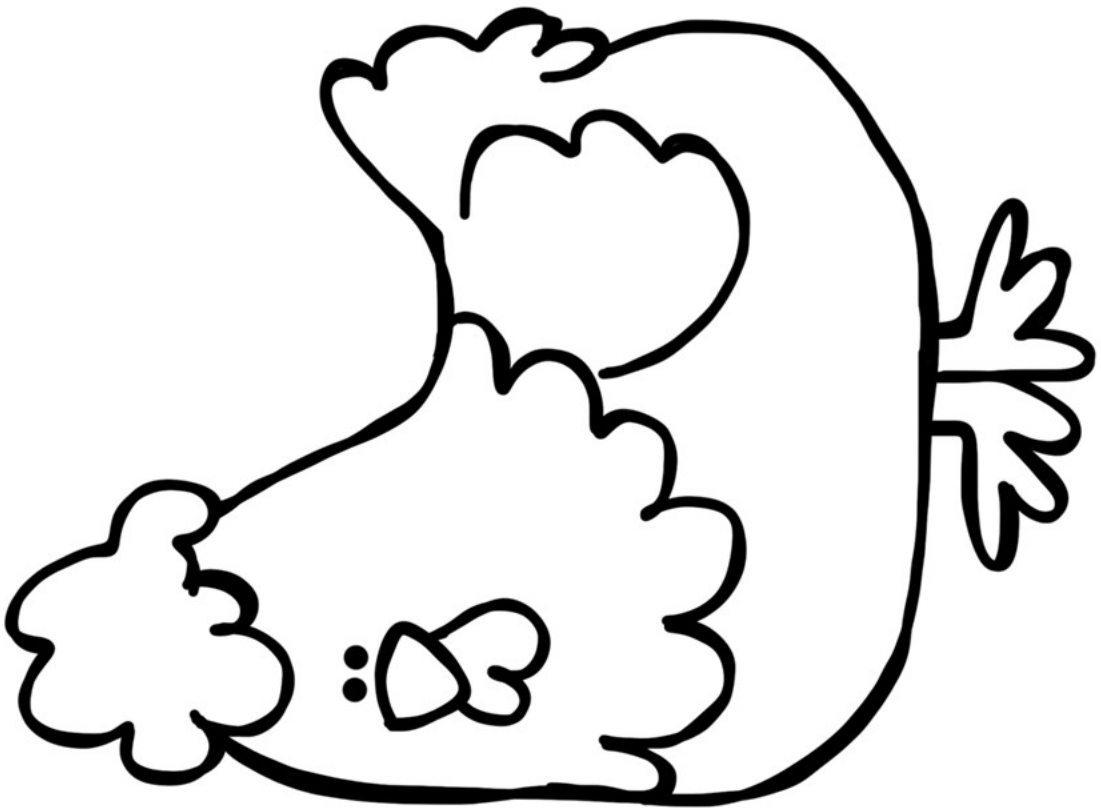

123 Learn Curriculum

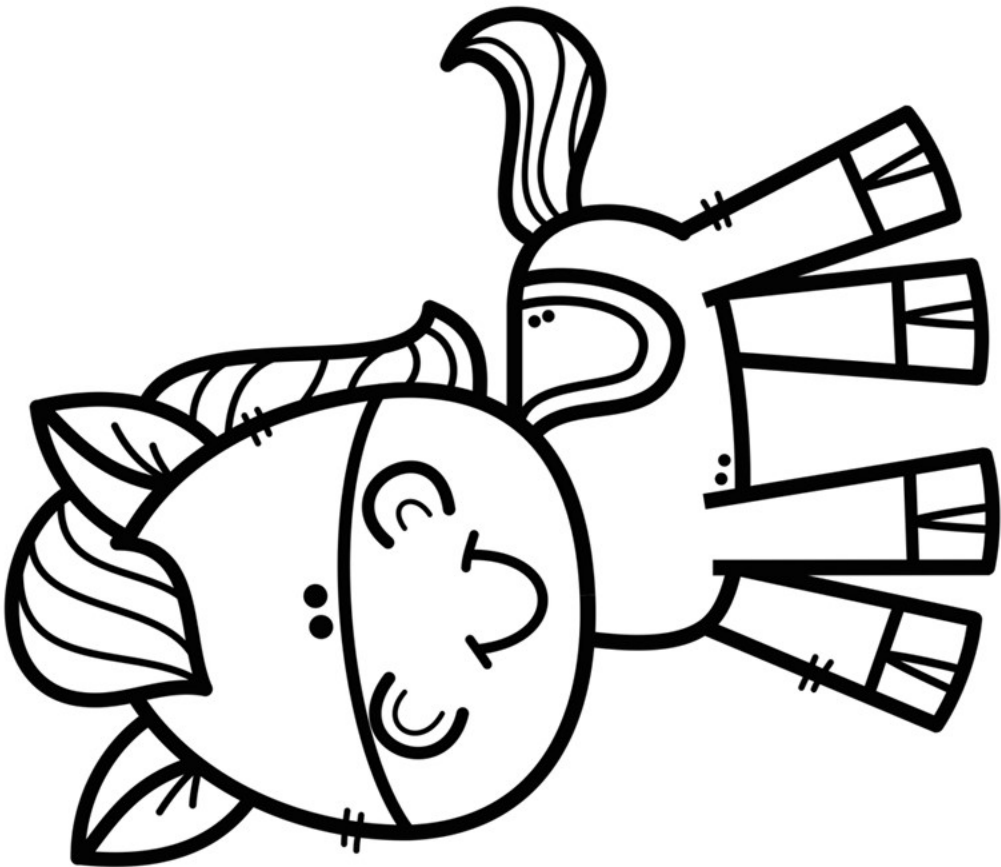

Teacher (s) _____ Week of: _____

Group: Infant

Theme: Down on the Farm

123 Learn Curriculum	Wednesday
Social Emotional	Activity: When talking with children, make eye contact. Look right into their eyes. When talking encourage them to coo or talk back.
	Component: Social Understanding and Relationships – S7 Building relationships
Approaches to Learning	Activity: Whisk Play
	Component: Initiative and Curiosity – AL1
Language Literacy Communications	Activity: Reading Daily – Farm Peekaboo! By DK Publishing– Plus other assorted theme related infant books.
	Component: Emergent Reading – L4 Motivation, engagement
The Arts	Activity: Singing or music playing daily
	Component: Exploring the Arts – A1
Social Systems Cognitive	Activity:
	Component:
Physical & Movement	Activity: Touch and Tell
	Component: P5-6: Fine Motor
Mathematics Cognitive	Activity:
	Component:
Scientific Thinking Cognitive	Activity:
	Component:

Wednesday

Whisk Play

Activity for 1 infant

Duration of activity: 5 – 10 minutes

Domain: Social and Emotional Development

Component: S6-8: Social Understanding and Relationships

Subcomponent: S7 Building Relationships

Child establishes and sustains relationships with others

S7.1 Shows a preference for a trusted adult

S7.2 Notices or responds to others

Domain: Approaches to Learning

Component: AL1-2 Initiative and Curiosity

Subcomponent: AL1 Inquisitiveness

Child explores the environment and seeks interaction with people and objects; willingly tries new things

AL1.1 Shows interest in the environment primarily through looking and Listening

Materials:

- Whisk
- Baby socks (3 pair – different colors)

Take a whisk and stuff infant socks inside with some of the socks hanging out. Sitting with infant on the floor and let them play with the whisk.

Show them that they can pull the socks out. Talk to them about how soft the socks are, these are socks for your feet, the colors of the socks.

The whisks above are great to use the smallest for the infants and the other sizes for toddlers and using pom poms. Never leave infant alone.



Wednesday

Reading Books

Activity for 1 or more infants

Duration of activity: 5 – 10 minutes

Skill activity support: social, emotional development and language

Domain: Social and Emotional

Component: Social Understanding and Relationships

Subcomponent: S7 Building Relationships

Child establishes and sustains relationships with others

S7.1 Shows a preference for a trusted adult

S7.2 Notices or responds to others

Domain: Language Literacy Communications

Component: LLC 5-13: Emergent Reading

Subcomponent: L4 Child has an interest in and sustained attention for literacy acts

L4.1 Likes to be read to and shown pictures

L4.2 Makes sounds while looking at text or images

Materials needed:

- Themed books

Spend time reading to the infant/s books that are theme related. You can check the down on the farm book list included with this lesson plan.



Wednesday

Touch and Tell

Ages 3 months – 12 months

Activity for 1 infant

Duration of activity: 5 – 10 minutes

Skill activity supports social and emotional development, cognitive and fine motor

Domain: Social and Emotional

Component: S6-8: Social Understanding and Relationships

Subcomponent: S7 Building Relationships

Child establishes and sustains relationships with others

S7.1 Shows a preference for a trusted adult

S7.2 Notices or responds to others

Domain: Physical and Movement Development

Component: P5-6: Fine Motor

Subcomponent P5 Dexterity:

Child can coordinate and control movement of hands and fingers to grasp and manipulate objects.

P5.2 Grasps small food objects using finger and thumb

Materials needed:

- Assorted food - Prepare several interesting foods for baby to touch, taste and smell – in small amounts – such as fruit flavored gelatin, yogurt, banana, o-shaped cereal, oatmeal, etc.
- Spread a plastic floor covering in the kitchen, and place the highchair on the covering. Seat baby in the highchair and place one food item on the tray, Let baby play with the food for a few minutes, exploring with her hands and mouth.
- Remove the food and offer a second item for exploration. Watch baby's expression as she examines each new food. Make sure to name and describe each item as you place it in front of baby.

Teacher (s) _____ Week of: _____

Group: Infant

Theme: Down on the Farm

123 Learn Curriculum	Thursday
Social Emotional	Activity: Be a positive role model: Offer children opportunities to observe you being a kind and caring person.
	Component: Social Understanding and Relationships – S7 Building relationships
Approaches to Learning	Activity: Making Noise
	Component: Initiative and Curiosity – AL1
Language Literacy Communications	Activity: Reading Daily – Farm Peekaboo! By DK Publishing– Plus other assorted theme related infant books.
	Component: Emergent Reading – L4 Motivation, engagement
The Arts	Activity: Singing or music playing daily
	Component: Exploring the Arts – A1
Social Systems Cognitive	Activity:
	Component:
Physical & Movement	Activity: Sticky Farm Animals
	Component: P5-6: Fine Motor
Mathematics Cognitive	Activity:
	Component:
Scientific Thinking Cognitive	Activity:
	Component:

Thursday

Making Noise

Ages 3 months – 12 months

Activity for 1 infant

Duration of activity: 10 – 15 minutes

Skill activity support: Senses

Goal: To increase large motor skills

Domain: Approaches to Learning

Component: AL1-2: Initiative and Curiosity

Subcomponent: AL1 Inquisitiveness

AL1.2 Responds to people by looking, kicking legs, vocalizing, reaching

Domain: Physical and Movement Development

Component: P5-6: Fine Motor

Subcomponent: P5 Dexterity

P5.1 Reaches for toy, grasp it and releases

Materials needed:

- Short Strings (Yarn)
- Rod or large string
- Canning jar rings, plastic bells, rattles

Directions: Using short strings, tie some noise making toys on a rod or line. Use some of the items listed above. Place infant in an infant seat or on his back under the rod. Shake some of the things to get his attention and help him hit at them.

Allow infant to lay and reach for and play with until he loses interest.

Alternate idea for older infants. Take items such as the canning jar rings or rattle and tie them to a piece of string. Encourage them to crawl after the items as you wiggle and make noise.

Make sure that the string isn't too long, and NEVER leave infant alone with the string.

Thursday

Sticky Farm Animals

Ages 3 months – 12 months

Activity for 1 2 infants

Duration of activity: 5 - 10 minutes

Skill activity supports cognitive – gross motor skills

Domain: Physical and Movement Development

Component: P5-6: Fine Motor

Subcomponent P5 Dexterity: Child can coordinate and control movement of hands and fingers to grasp and manipulate objects

P5.3 Transfers object from one hand to another hand

Domain: Approaches to Learning

Component: AL1-2 Initiative and Curiosity

Subcomponent: AL1 Inquisitiveness

Child explores the environment and seeks interaction with people and objects; willingly tries new things

AL1.1 Shows interest in the environment primarily through looking and listening

Domain: Social and Emotional Development

Component: S6-8: Social Understanding and Relationships

Subcomponent: S7 Building Relationships

Child establishes and sustains relationships with others

S7.1 Shows a preference for a trusted adult

S7.2 Notices or responds to others

Materials needed:

- Clear contact paper
- Painter's tape
- Wooden farm animals (Puzzle pieces, wooden farm pieces)

Tape a piece of contact paper, decide the size you would like to use. Pull the back off and attach to a wall using painter's tape. Sticky side out.

Thursday

Sticky Farm Animals

Ages 3 months – 12 months

Activity for 1 2 infants

Duration of activity: 5 - 10 minutes

You will want to hang the contact paper low enough so infant can sit and reach for pieces. Younger infants you can sit on your lap and see if they are interested in grabbing pieces.

Stick puzzle pieces to the sticky side of the contact paper. Using puzzle pieces with little pegs can help infant grab the pieces, but nice thick pieces would work good for infants to grab with their fingers.

A sample of thick wooden pieces is below, and available on Amazon. This is a toy that you can use for this activity and then leave out year-round in your block center or on a shelf for toddlers and preschoolers.

Activity would also be fun for toddlers, help to develop with their small motor skills.



*NEVER leave
infant alone with
activity.*

Teacher (s) _____ Week of: _____

Group: Infants

Theme: Down on the Farm

123 Learn Curriculum	Friday
Social Emotional	Activity: Be a positive role model: Offer children opportunities to observe you being a kind and caring person.
	Component: Social Understanding and Relationships – S7 Building relationships
Approaches to Learning	Activity: Hold 2 Things
	Component: Initiative and Curiosity – AL1
Language Literacy Communications	Activity: Reading Daily – Farm Peekaboo! By DK Publishing– Plus other assorted theme related infant books.
	Component: Emergent Reading – L4 Motivation, engagement
The Arts	Activity: Singing or music playing daily
	Component: Exploring the Arts – A1
Social Systems Cognitive	Activity:
	Component:
Physical & Movement	Activity: Tape Pull
	Component: P5-6: Fine Motor
Mathematics Cognitive	Activity:
	Component:
Scientific Thinking Cognitive	Activity:
	Component:

Friday

Hold 2 Things

Activity for 1 infant

Duration of activity: 5 – 10 minutes

Domain: Approaches to Learning

Component: AL1-2 Initiative and Curiosity

Subcomponent: AL1 Inquisitiveness

Child explores the environment and seeks interaction with people and objects; willingly tries new things

AL1.1 Shows interest in the environment primarily through looking and listening

Domain: Physical and Movement Development

Component: P5-6: Fine Motor

Subcomponent P5 Dexterity: Child can coordinate and control movement of hands and fingers to grasp and manipulate objects

P5.3 Transfers object from one hand to another hand

Skill activity supports: Fine Motor, Large Motor

Goal: Getting infant to spend time working on fine motor. If sitting, also working on large motor.

Materials:

- Dishpan or small plastic container
- A few small toys (use animal rattles)

Directions:

Sit infant on the floor and place a small dishpan or plastic container on the floor in front of him. Sit directly across from him on the other side of the bin. In the bin place small toys, and if possible, make them theme related. (Otherwise place rattles, blocks, etc. in the container). Give the infant two toys, one at a time, to hold. If he drops a toy, hold up another toy up to his empty hand for him to grasp.

*Here's a rattle Henry.
Can you hold another one?
Now you have two?*



Suggestions for Friday Activity - Hold 2 Things and Infant Games and Manipulates From Amazon.com

Click on picture to be brought directly to Amazon. You can also visit <http://www.amazon.com>, type rattles and see what they have available. Buy items that you can use with this theme and use year after year.



Friday

Tape Pull

Duration of activity: 5 – 10 minutes

Domain: Social and Emotional Development

Component: S6-8: Social Understanding and Relationships

Subcomponent: S7 Building Relationships

Child establishes and sustains relationships with others

S7.1 Shows a preference for a trusted adult

S7.2 Notices or responds to others

Domain: Physical and Movement Development

Component: Fine Motor

Subcomponent: P5 Dexterity Child can coordinate and control movement of hands and fingers to grasp and manipulate objects.

P5.1 Reaches for toy, grasp it and releases

Materials:

- Assorted colored masking tape.

Directions:

Sit infant in highchair, and on the tray of the highchair place strips of tape leaving a small tail of each tape for infant to pull on.

Talk to infant about the sticky of the tape, color they are pulling on. Once they pull the tape off, you can bunch it together and place back on the tray.

NEVER leave infants alone with this activity.



Down on the Farm Posters

- 2 Different size posters
- Print up on white card stock.
- B & W template - color
- Laminate and hang up during down on the farm theme.



Additional idea: Print pages up and staple together to make a farm color book. There is a cover for the book in color and b & w. Place a blank piece of card stock in the back for a back cover. You have 2 options. Large or small posters.

Color Posters

Also includes a cover if you want to
make this into a book.

Down on the Farm



Barn

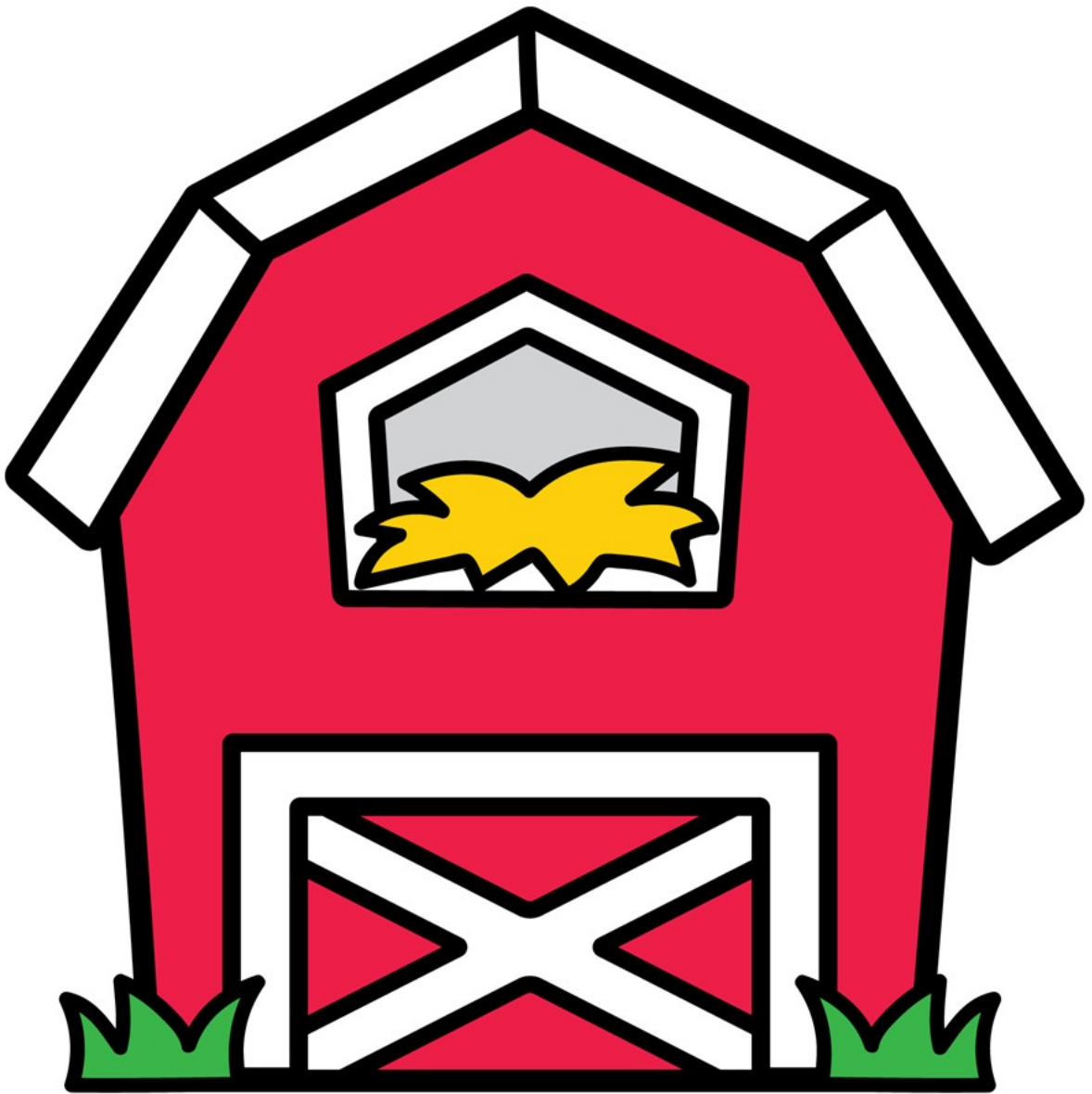

Horse

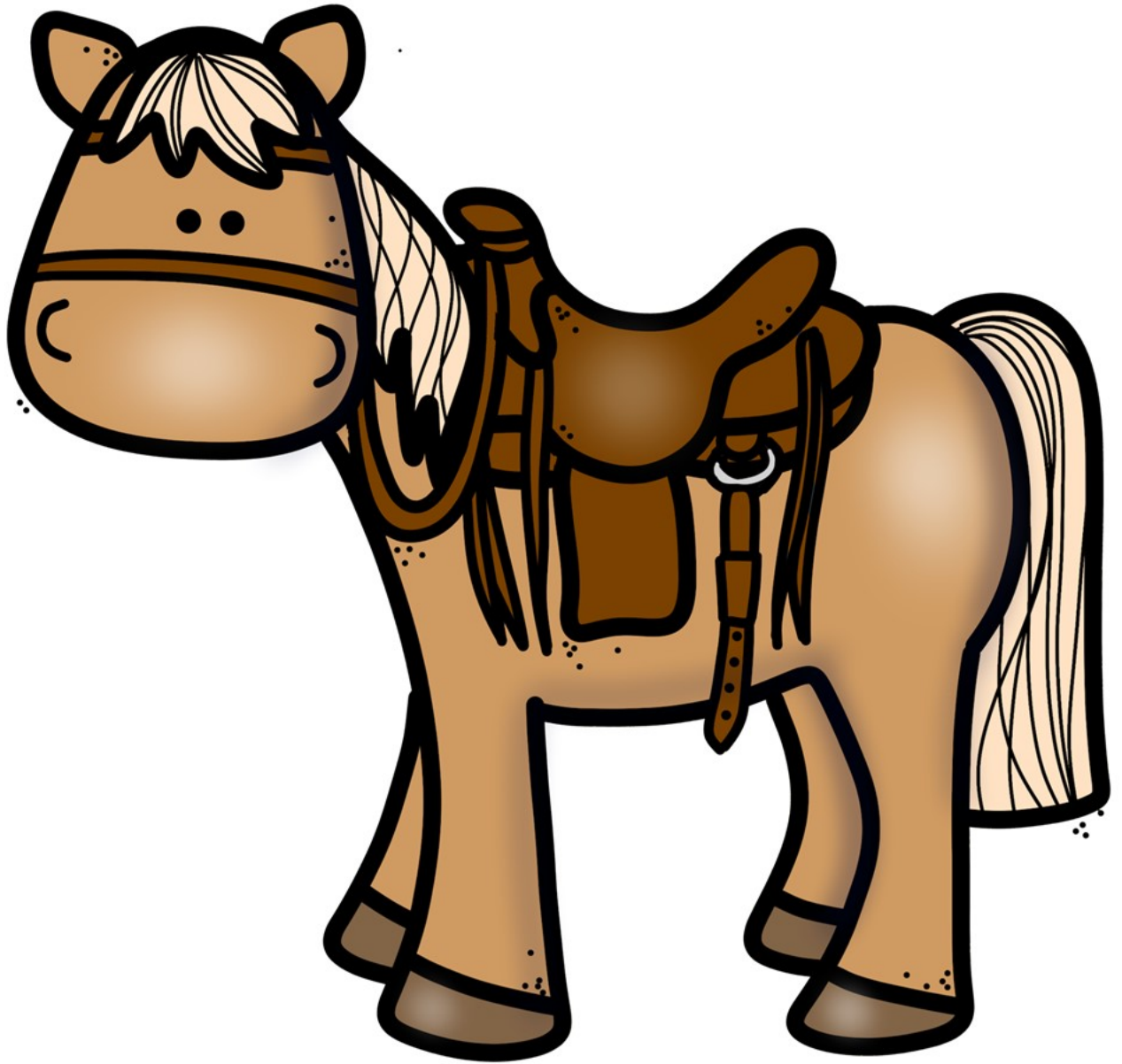

Farmer



Tractor

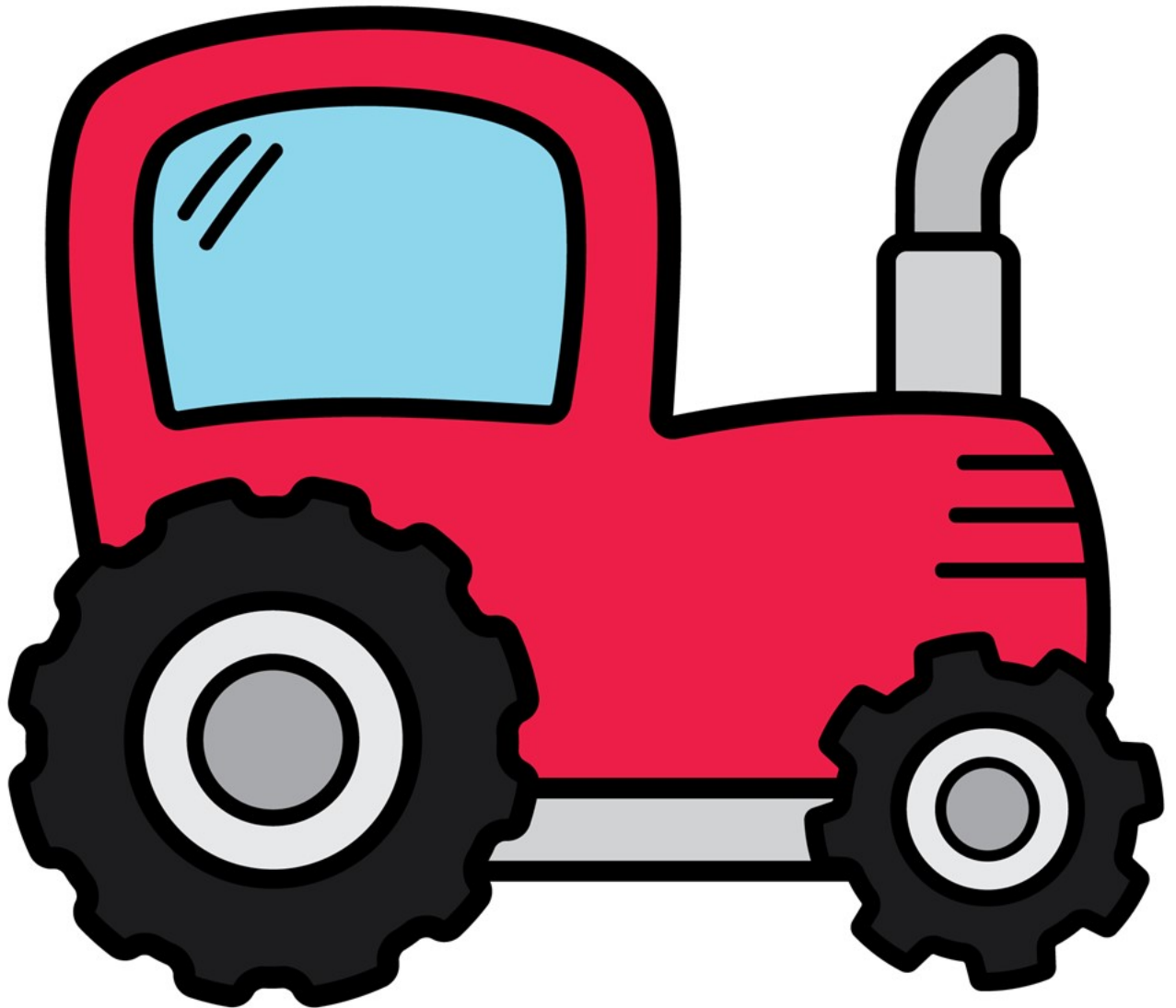

Cow

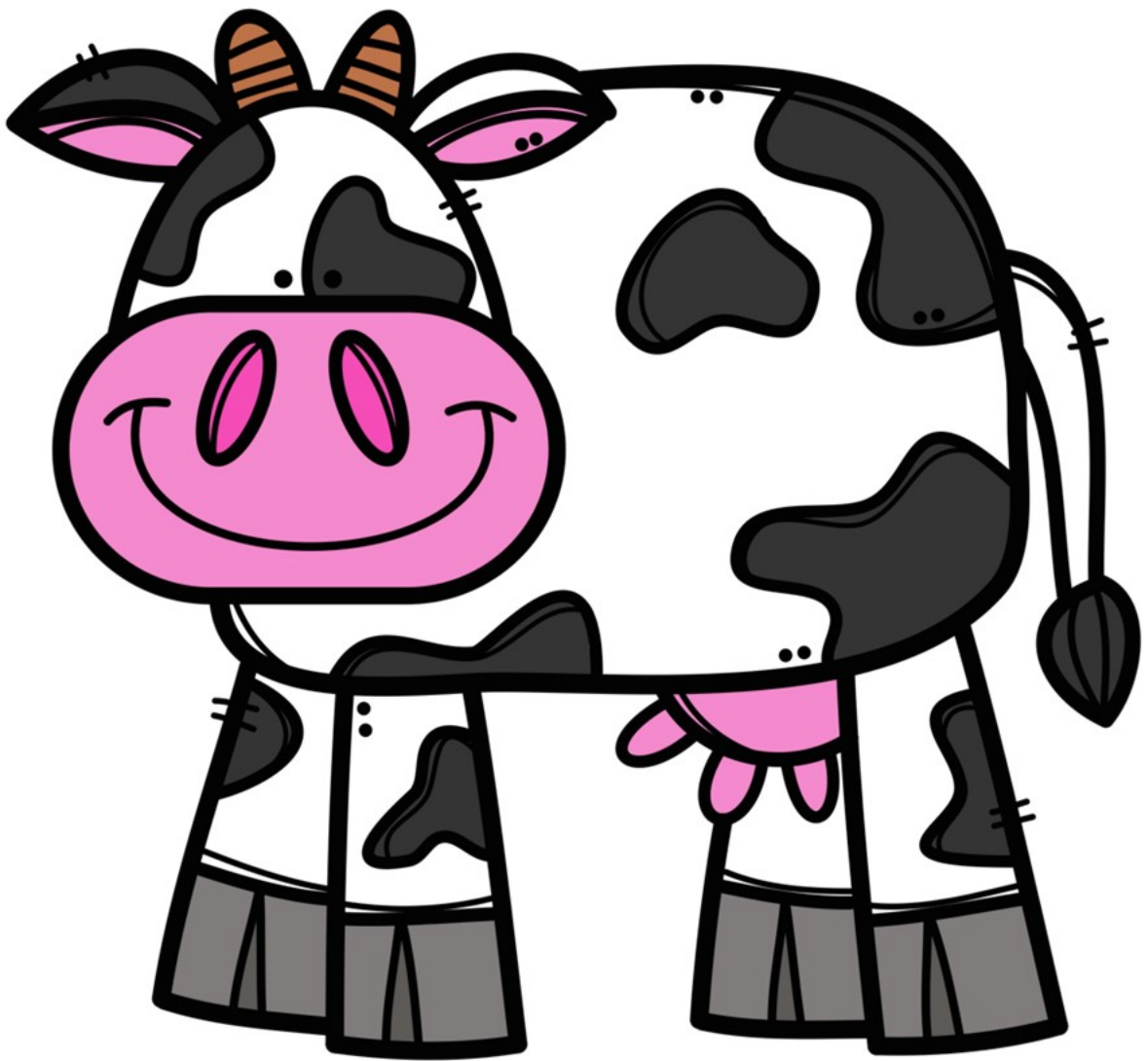

Rooster

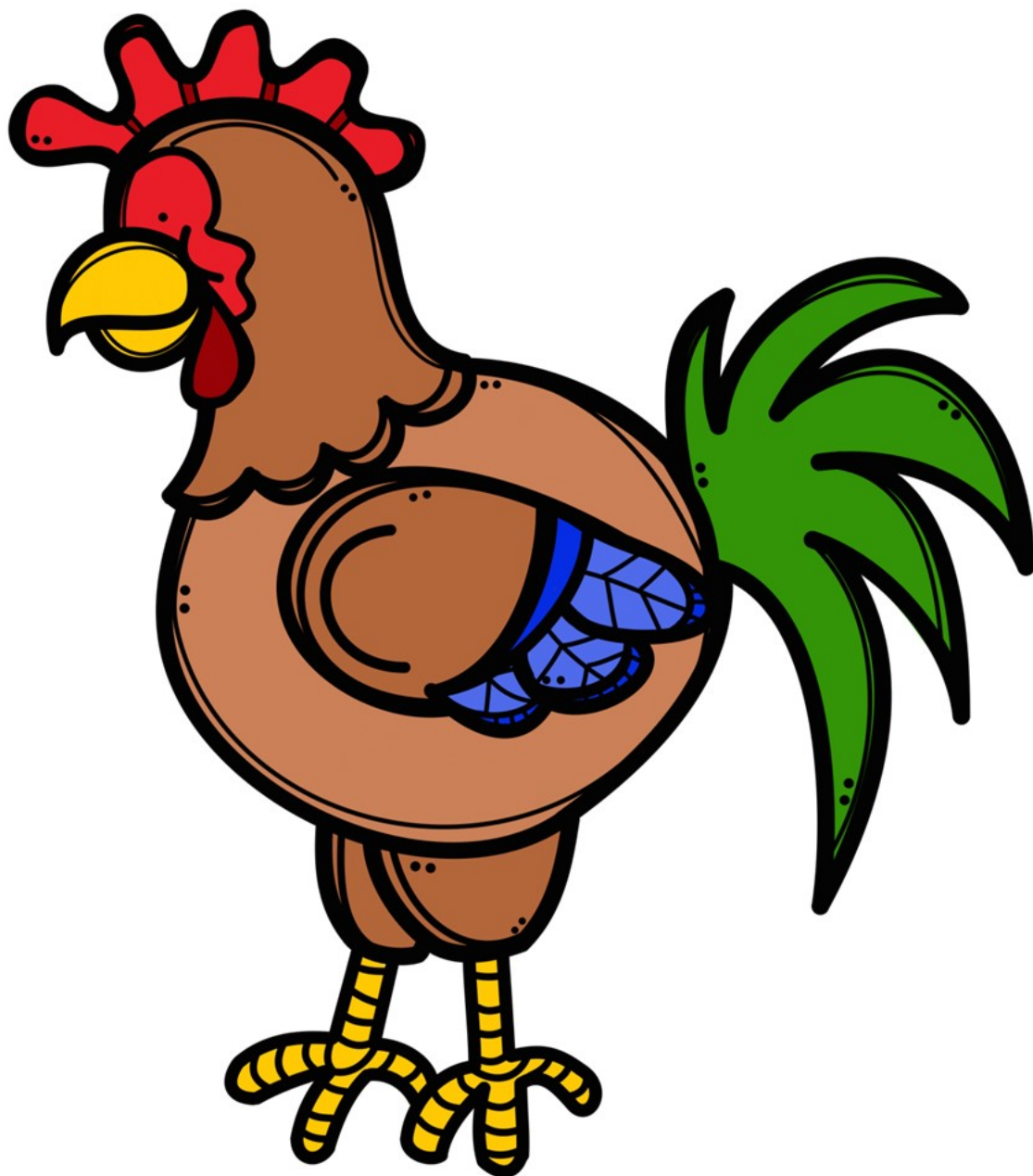

Chick

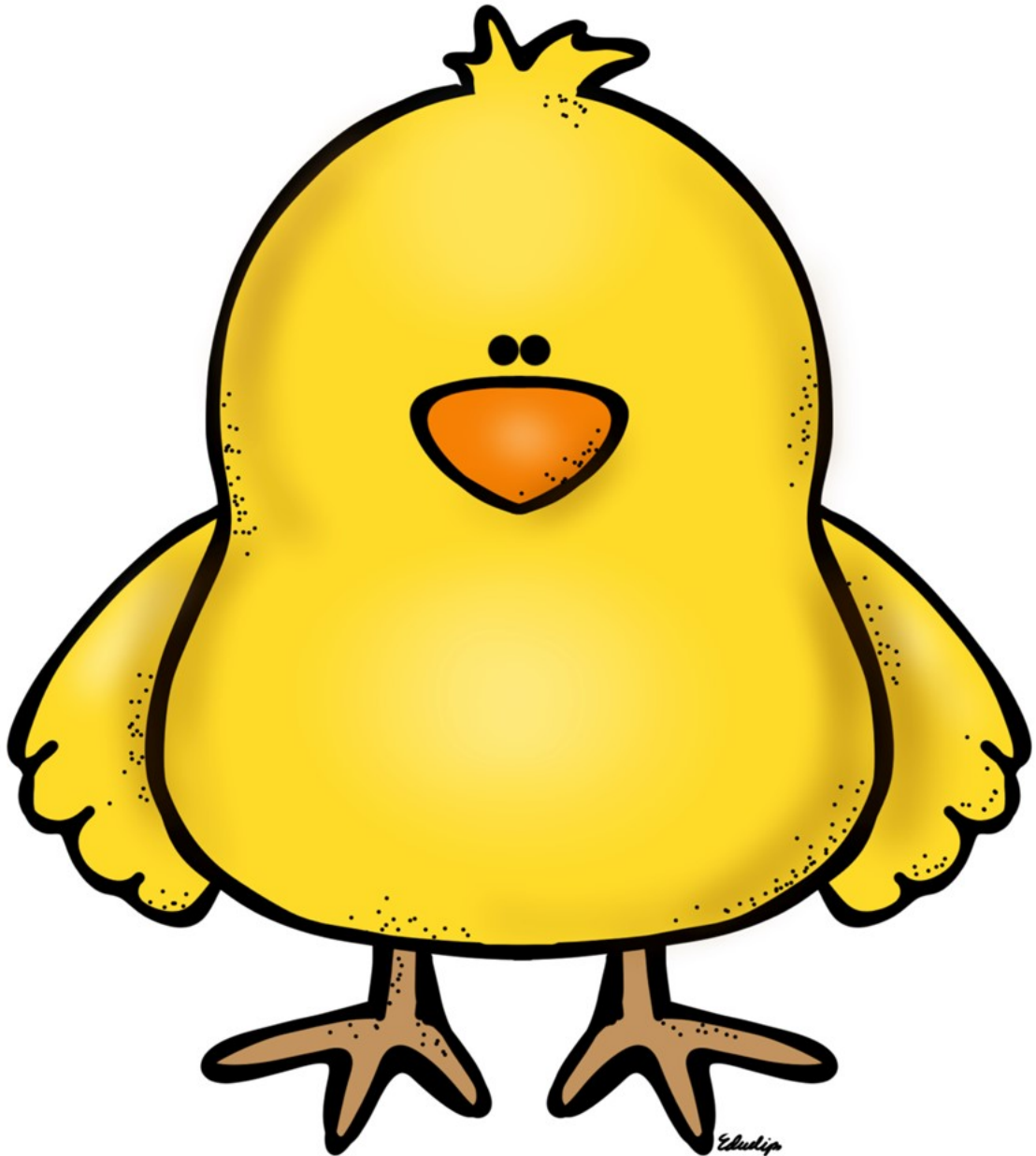

Pig

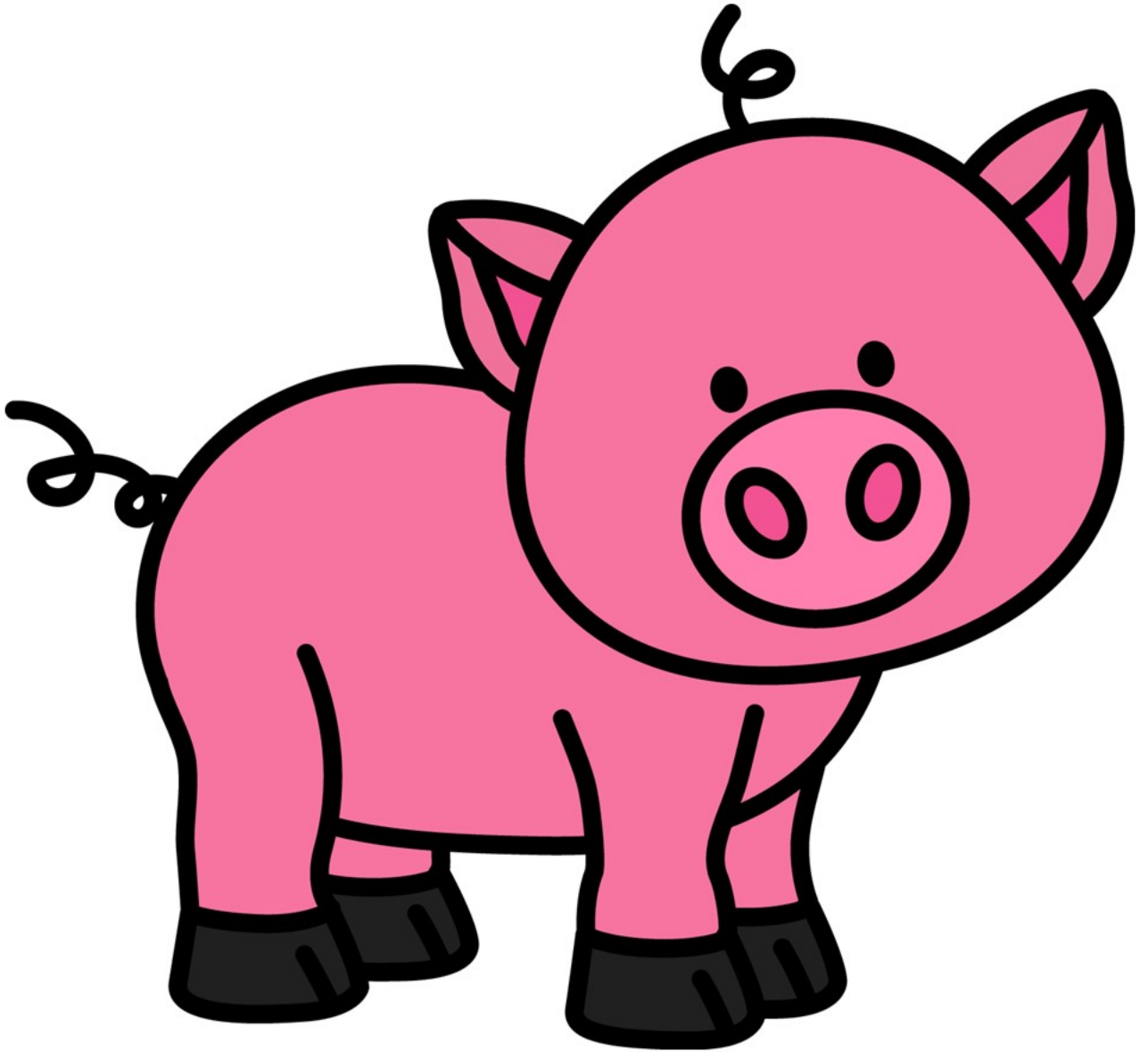

Sheep



Corn

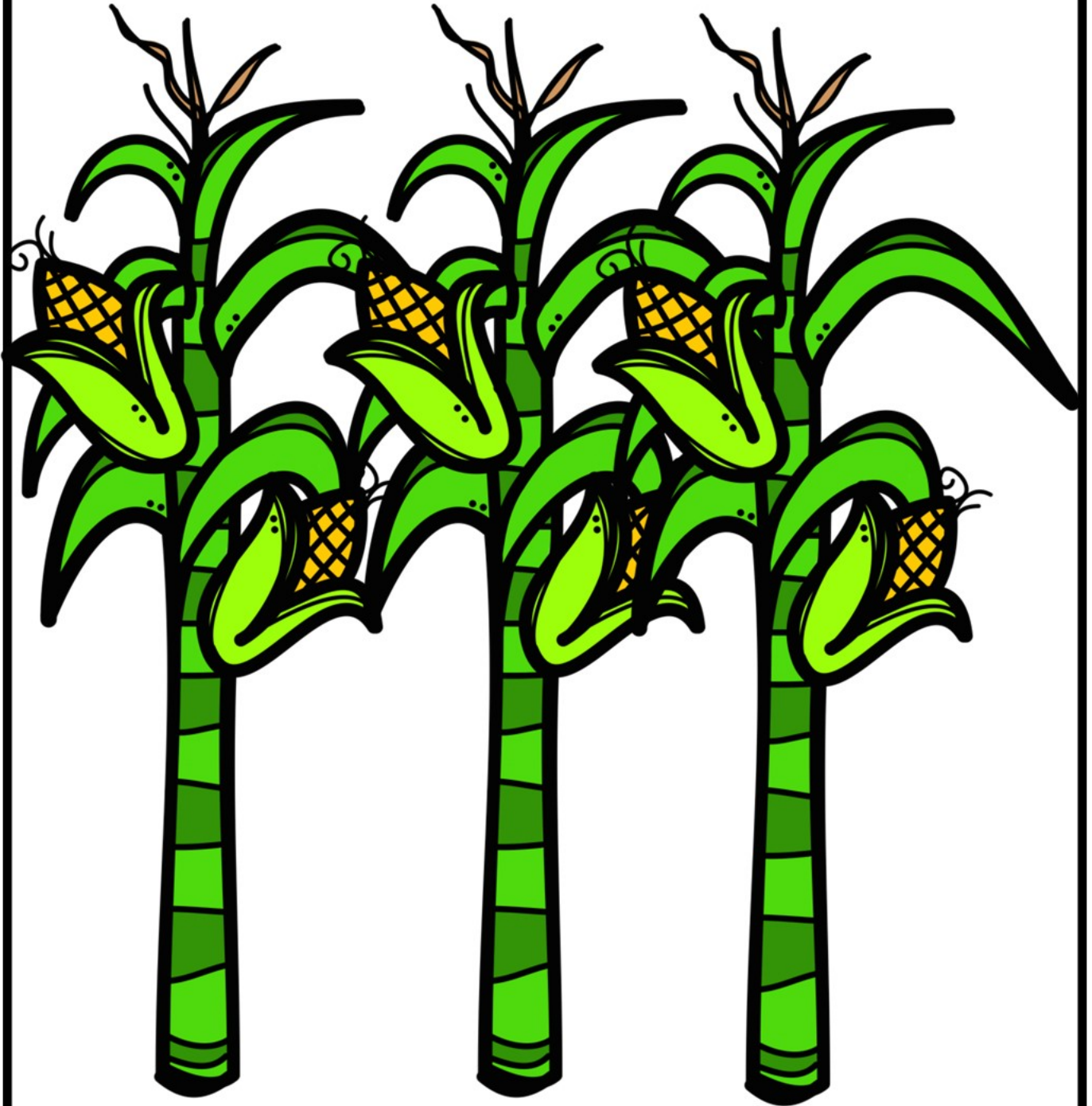

B & W Posters

Also includes a cover if you want to make this into a coloring book.

Down on the Farm



Barn

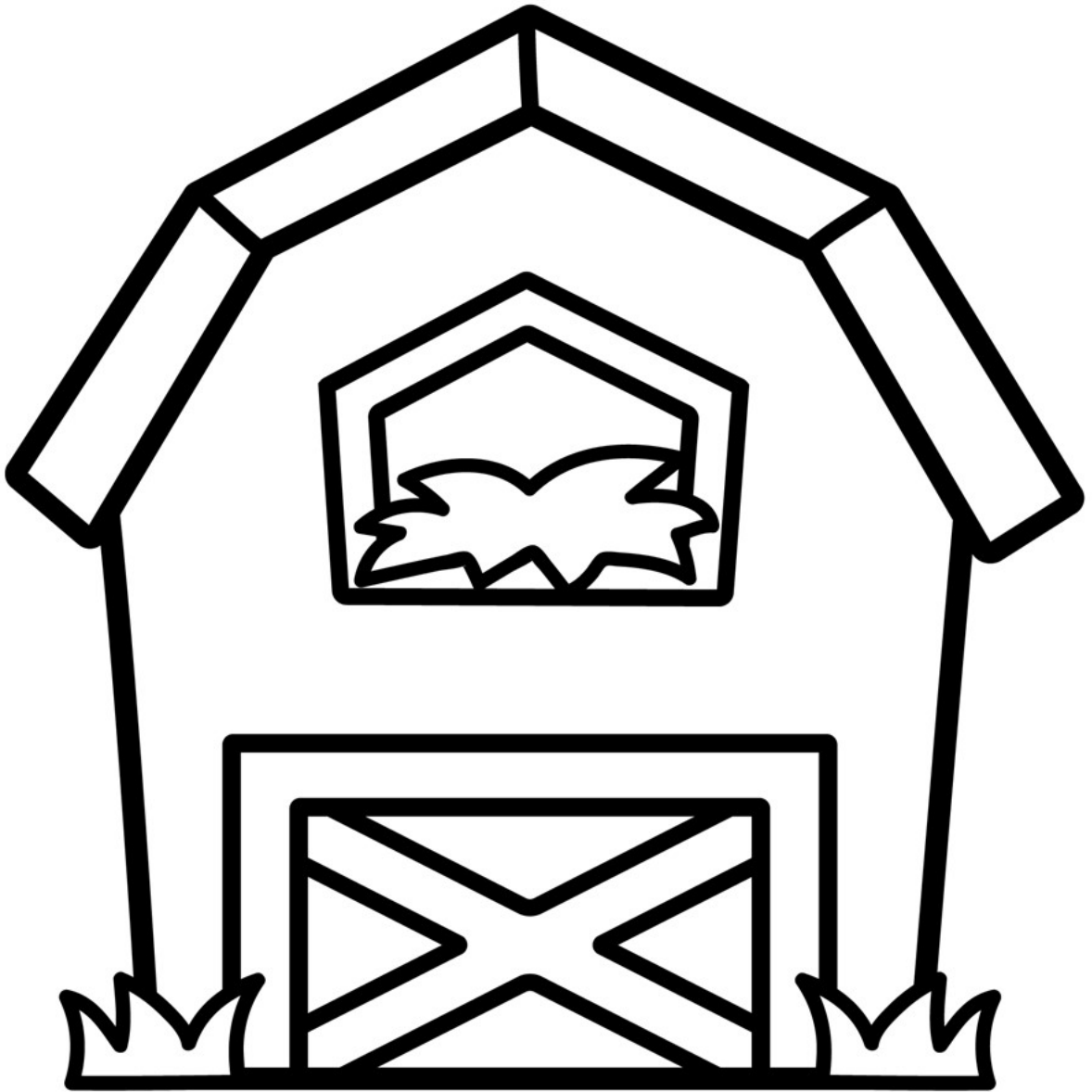

Horse

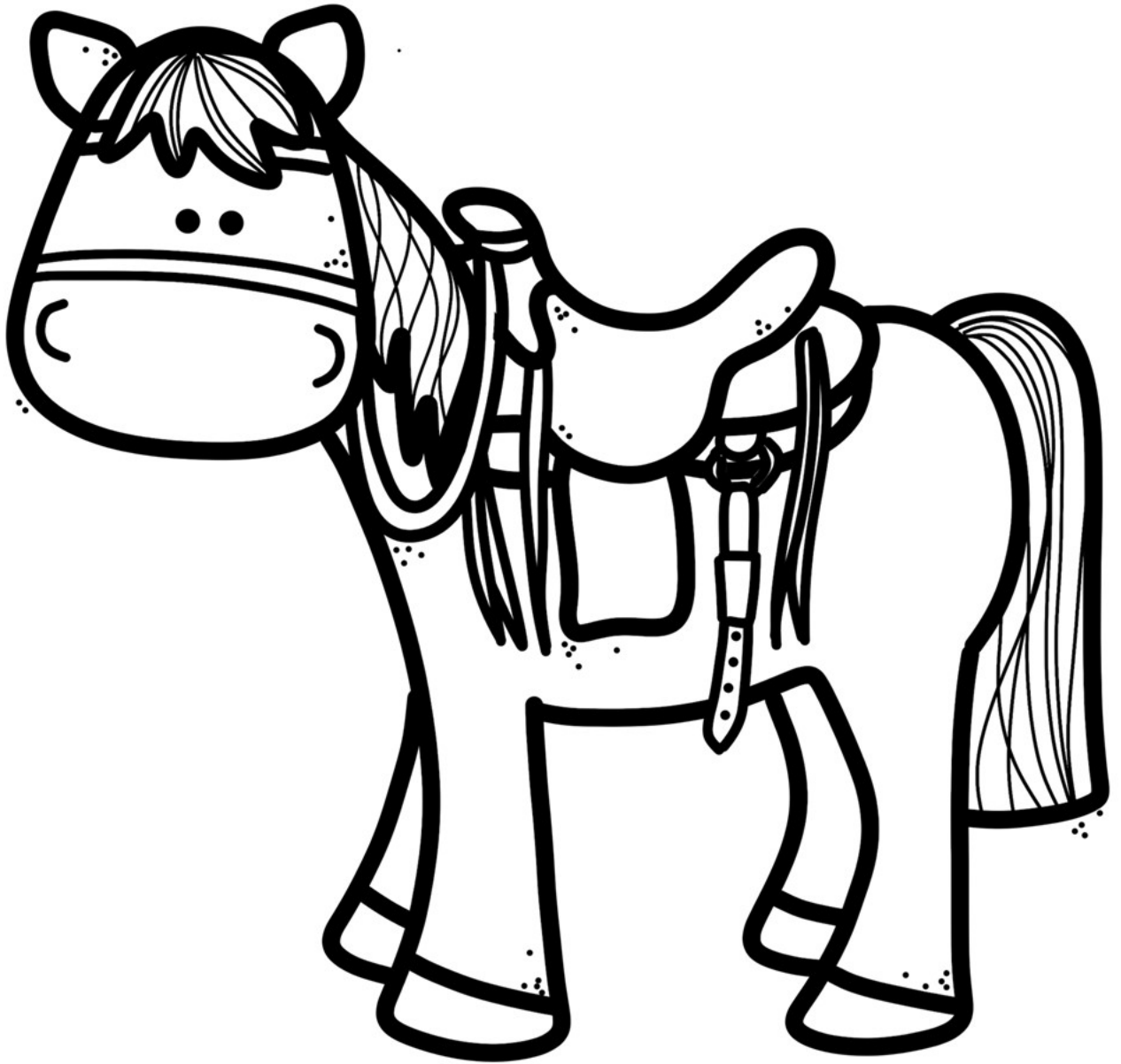

Farmer

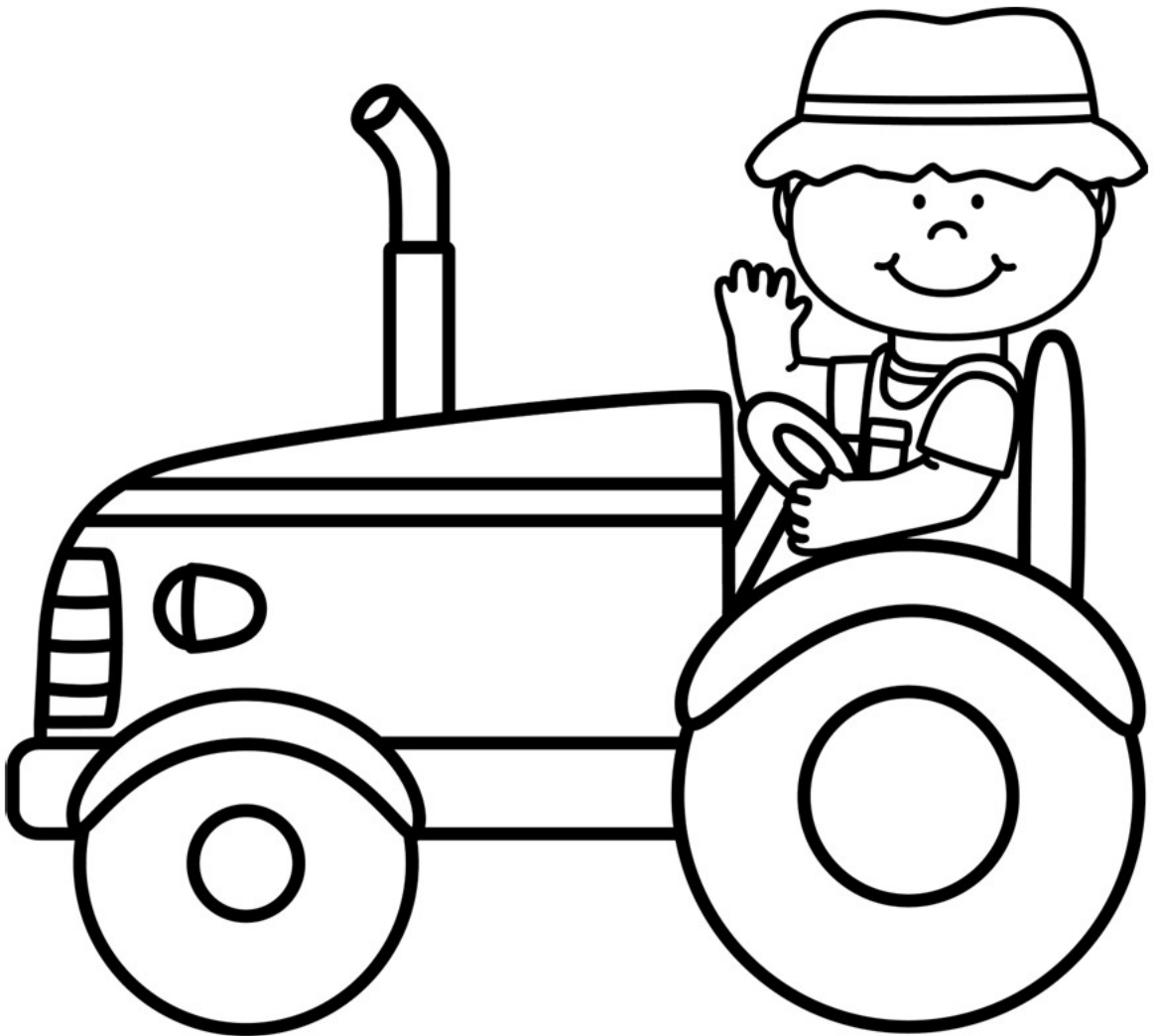

Tractor

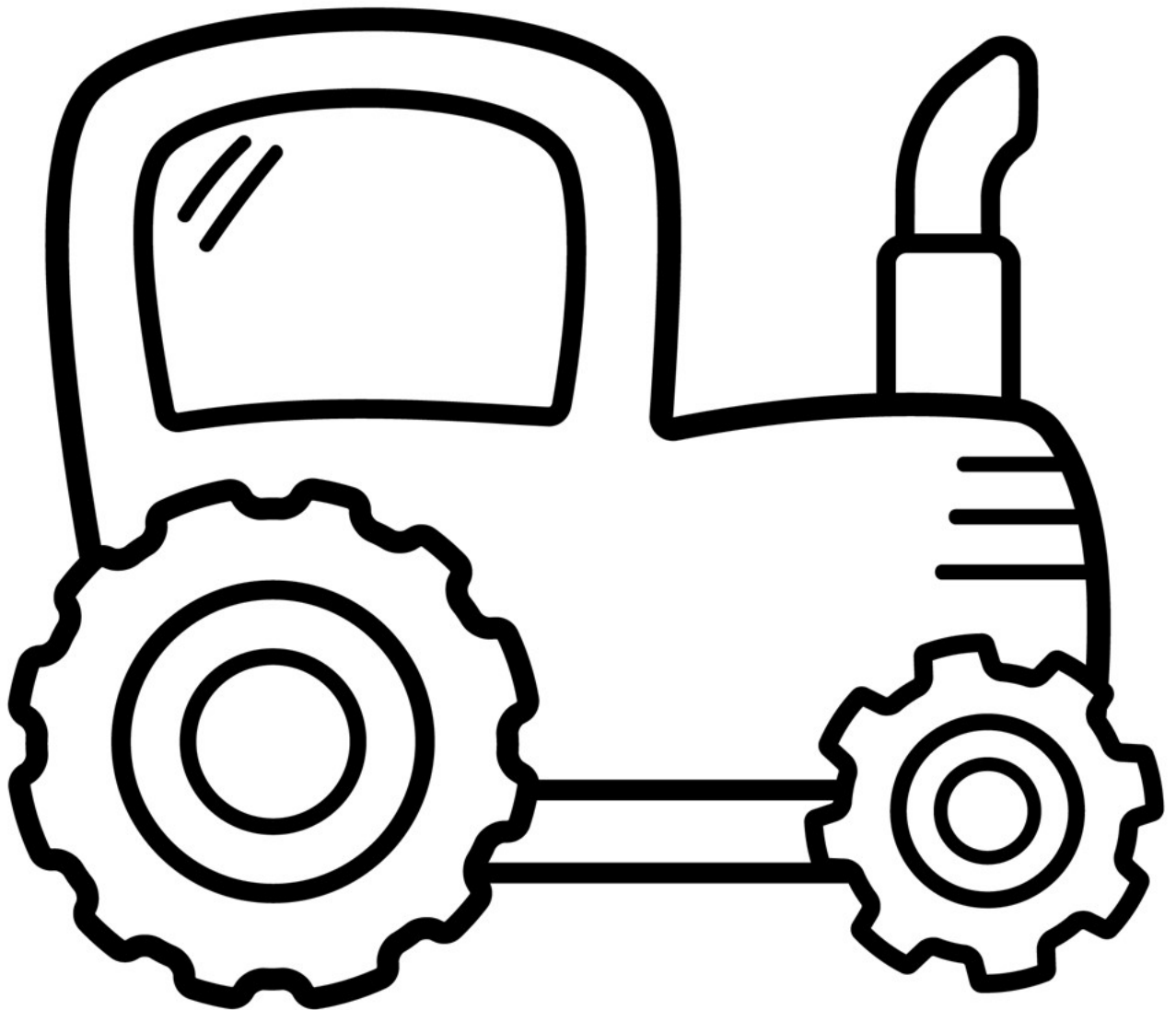

Cow

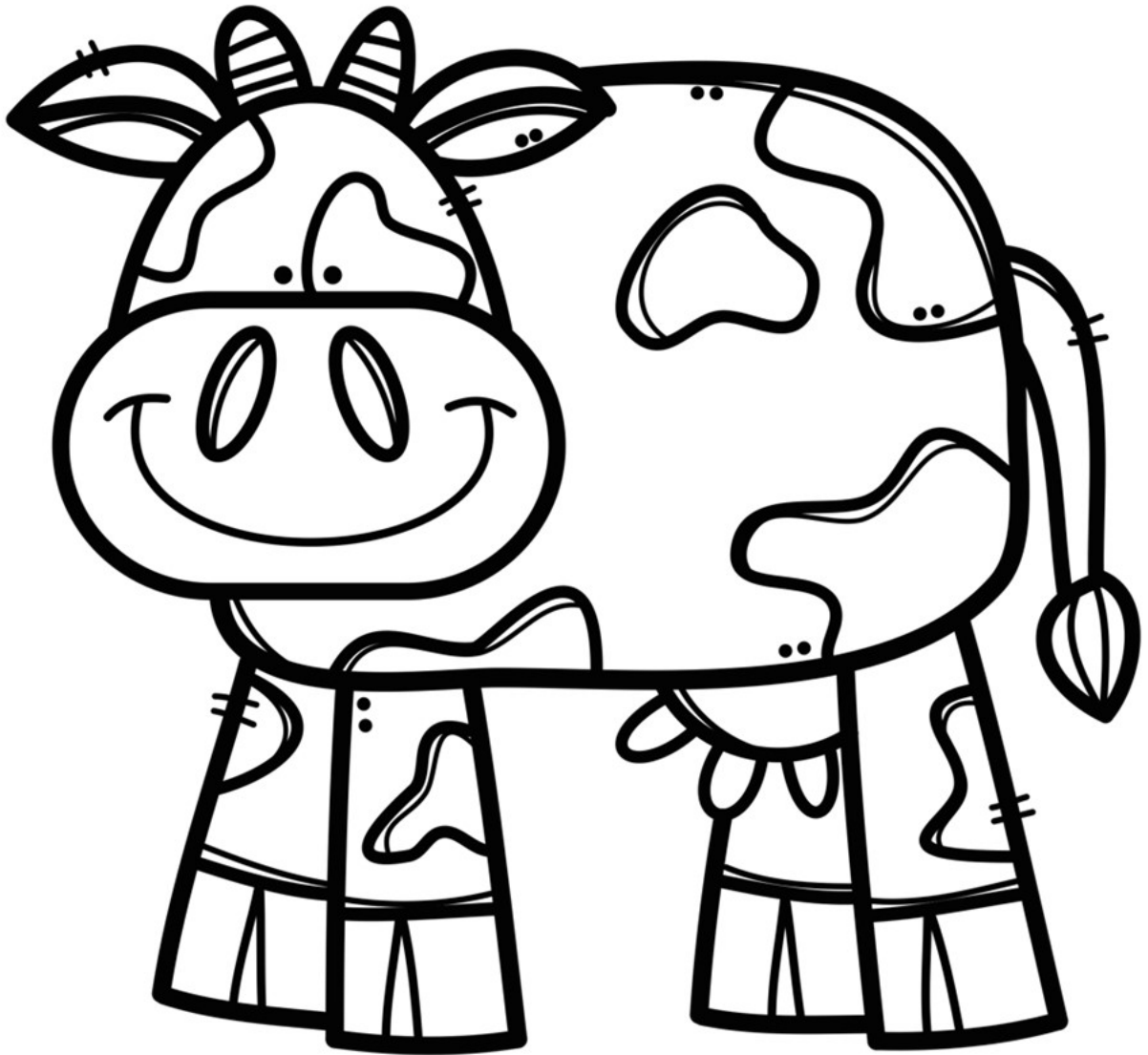

Rooster

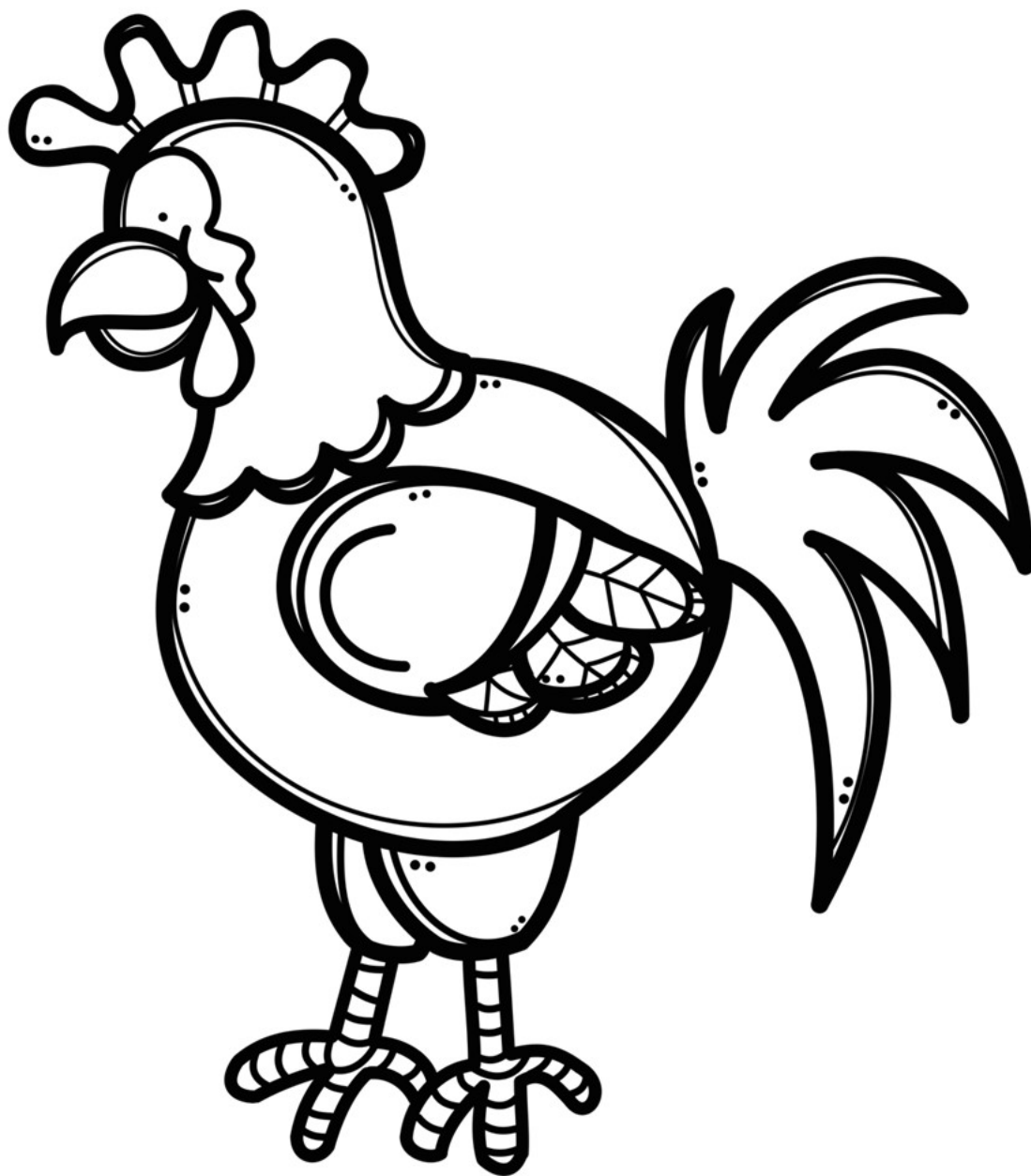

Chick

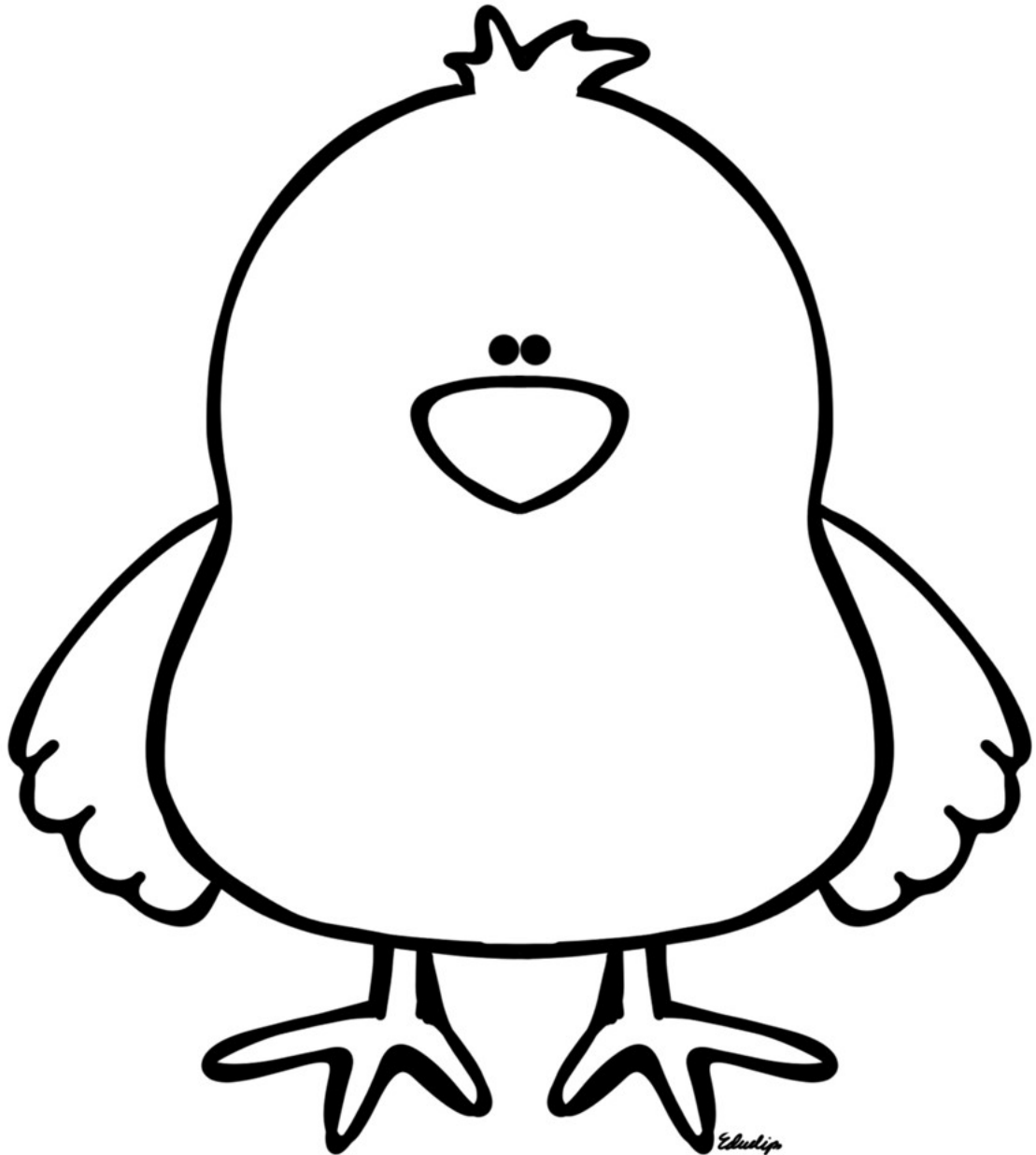

Pig

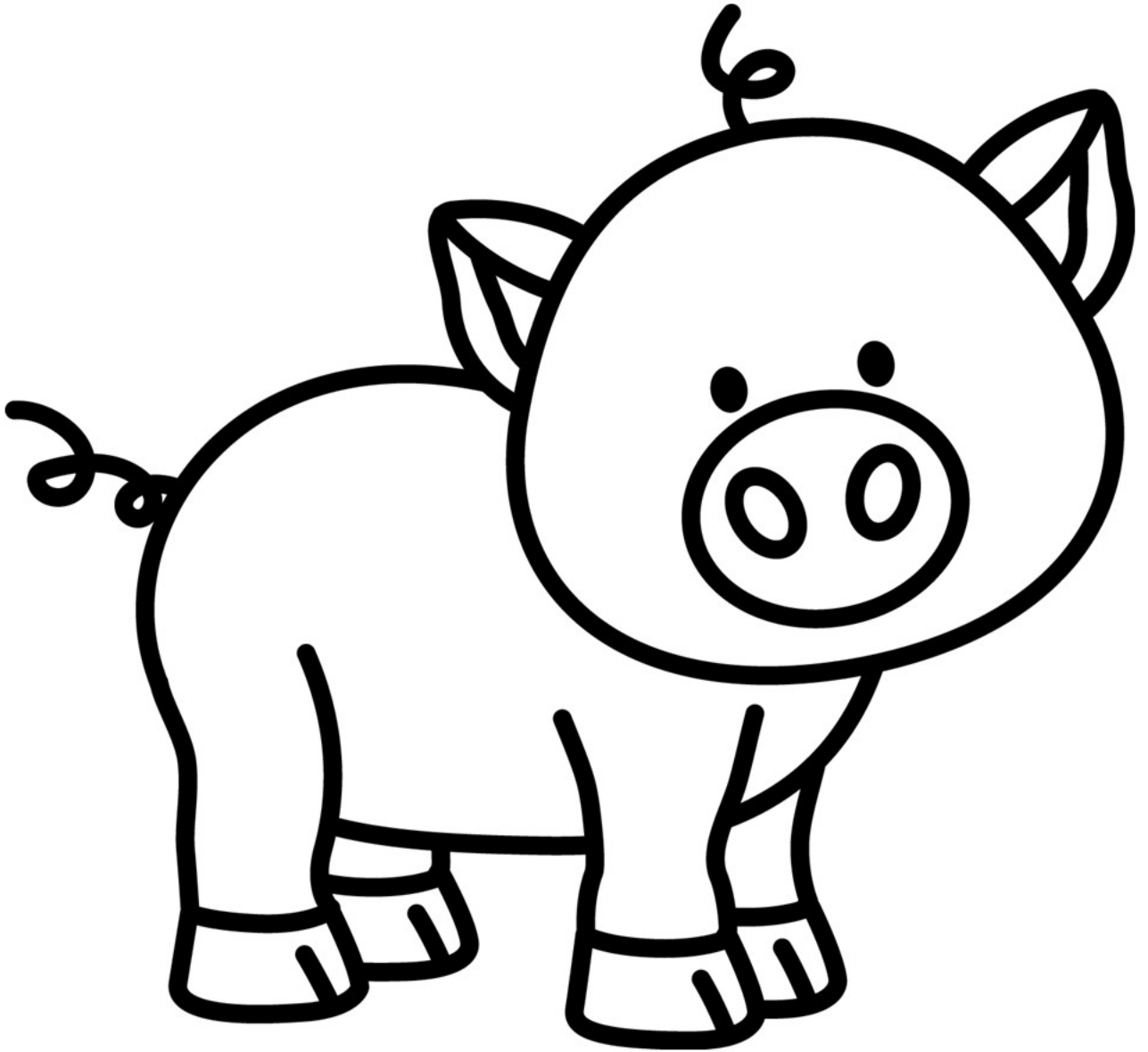

Sheep

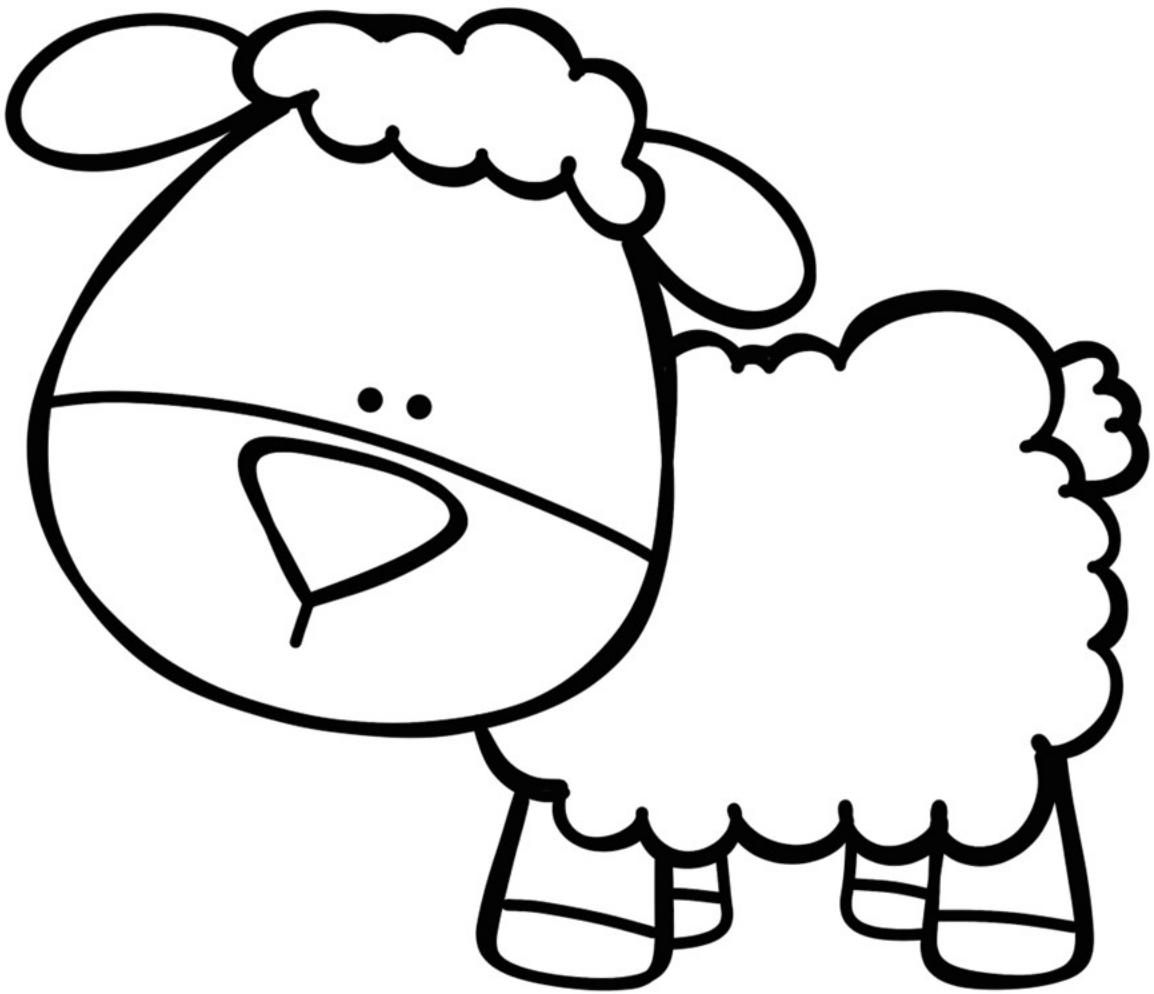

Corn

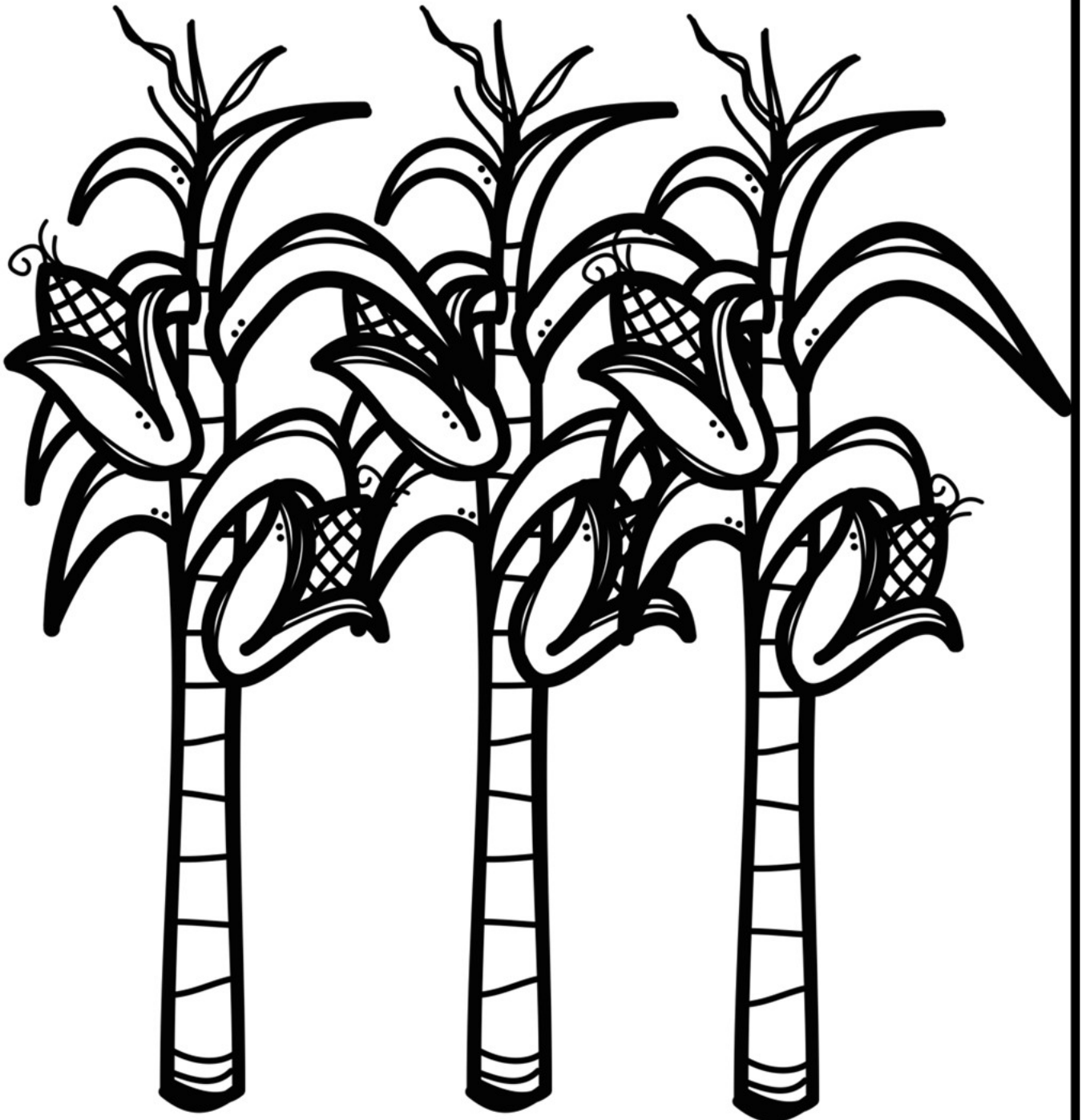

Color Posters

Also includes a cover if you want to
make this into a book.

Small version.

Down on the Farm

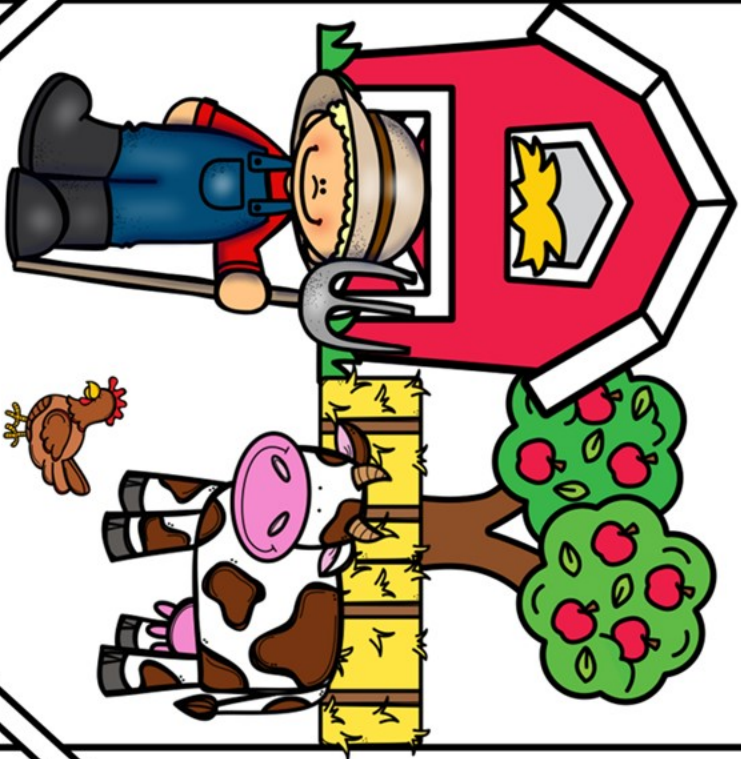

123 Learn Curriculum

Barn

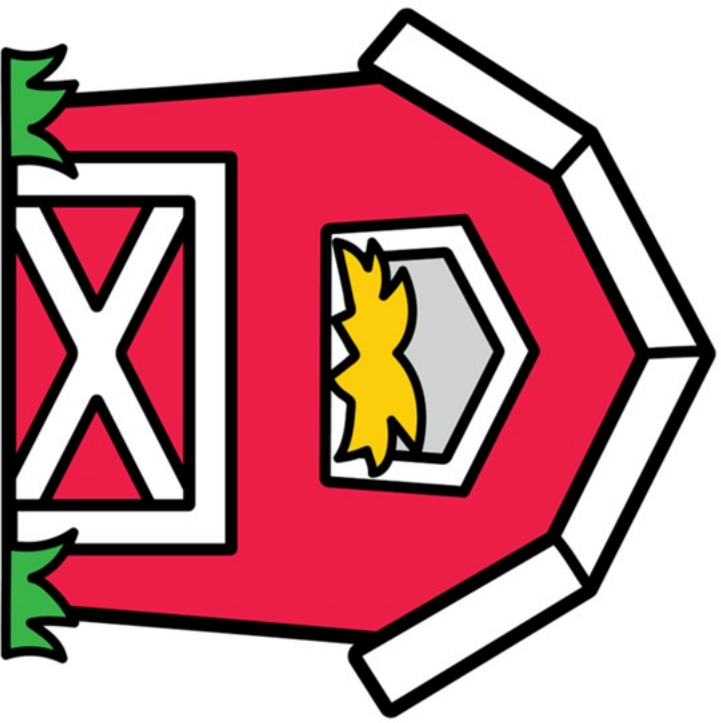

123 Learn Curriculum

Horse



Farmer

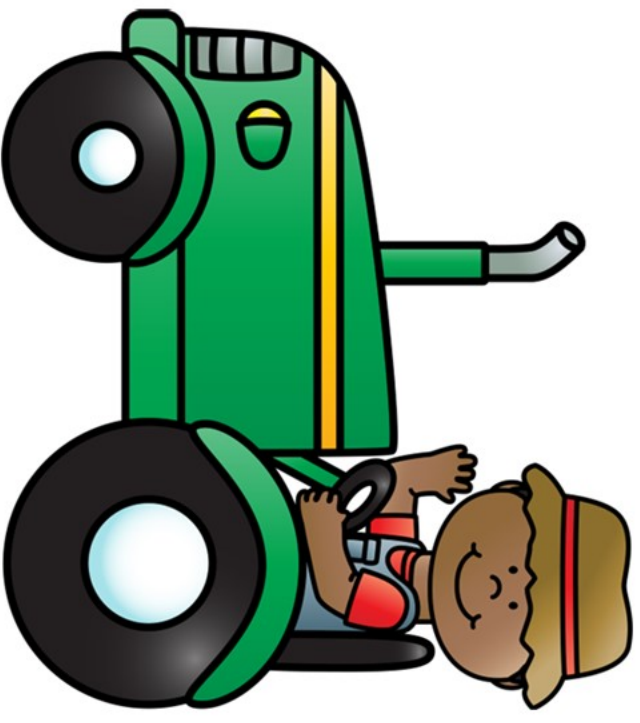

Tractor

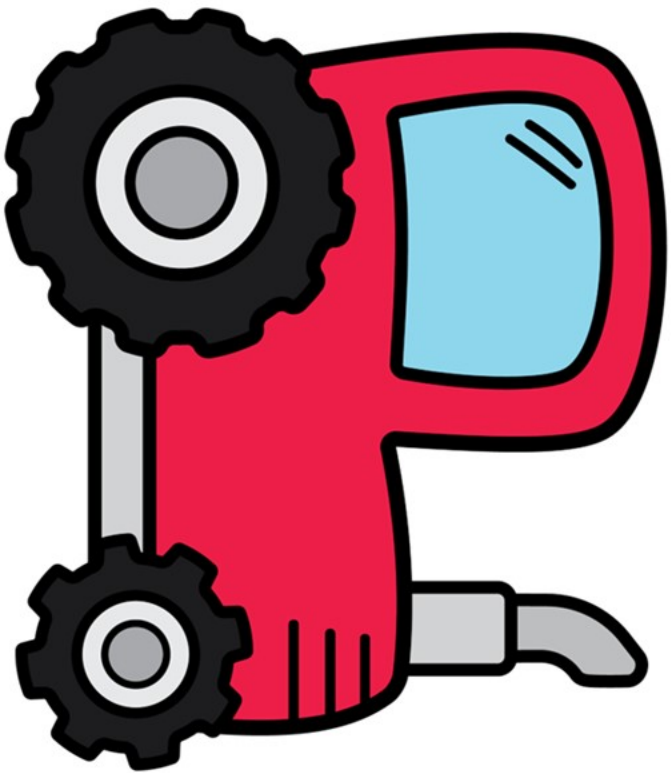

Cow

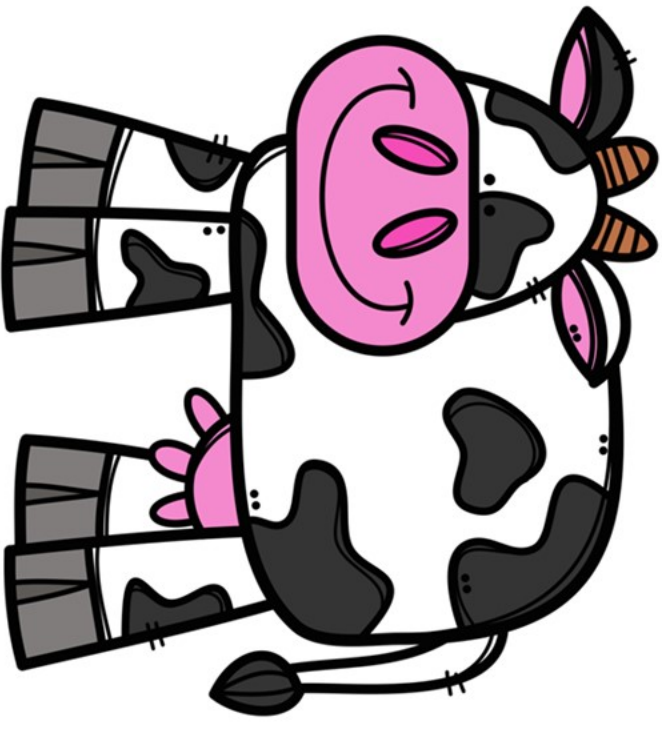

Rooster

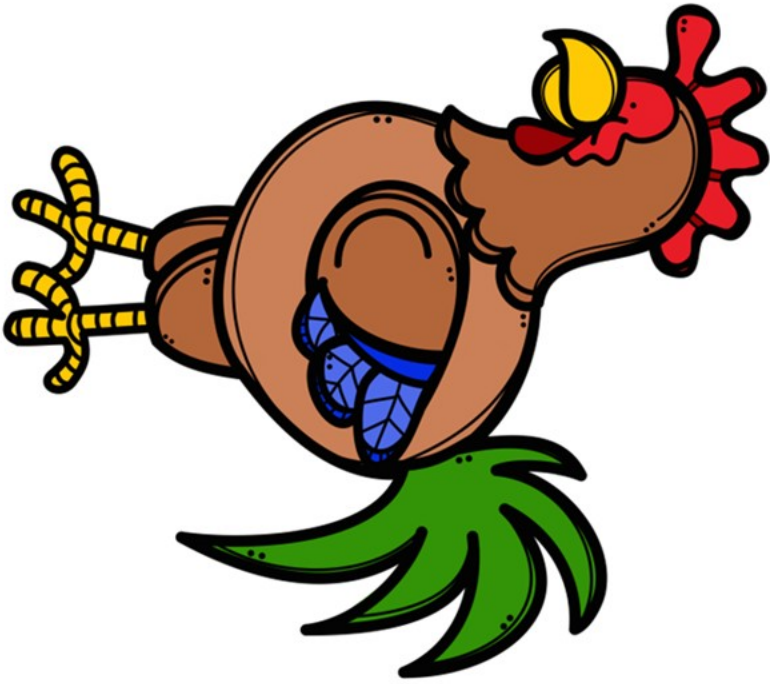

Chick

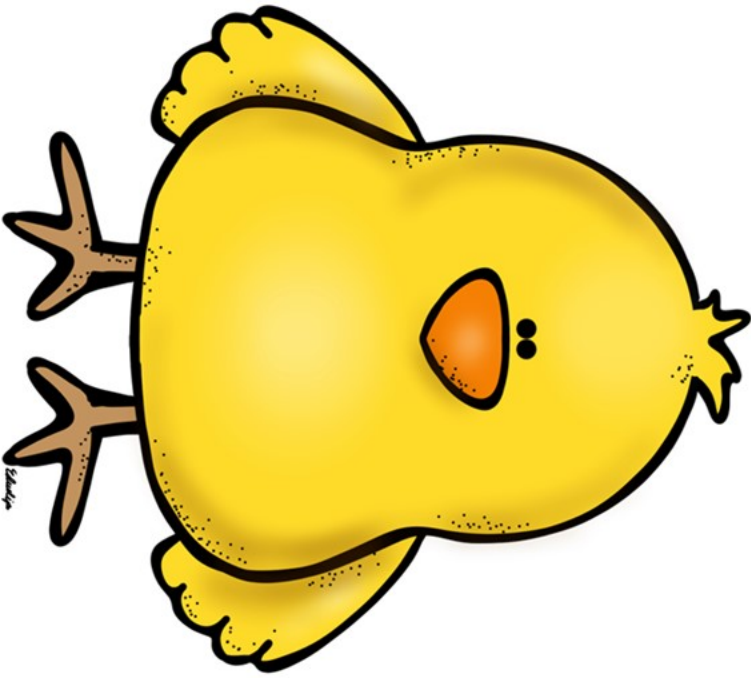

Pig

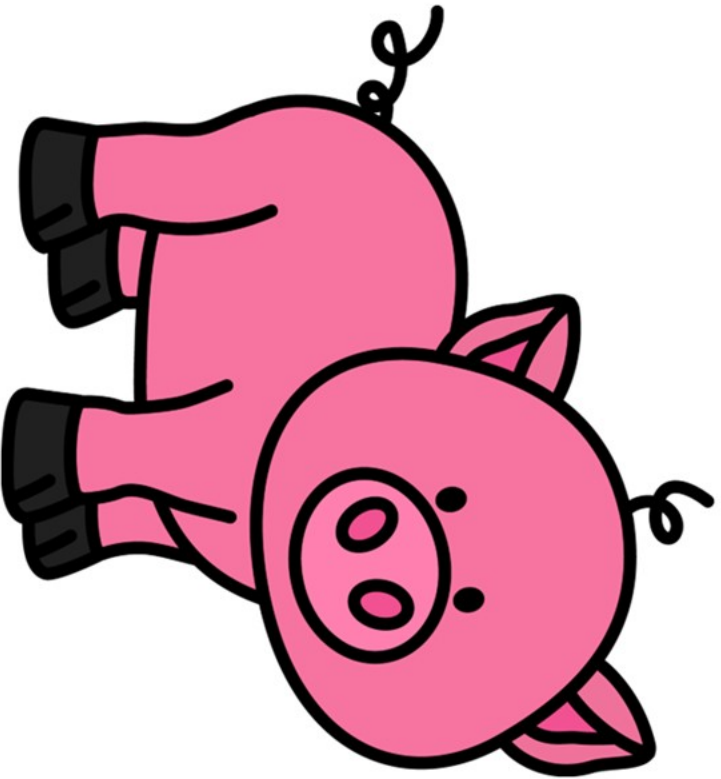

Sheep



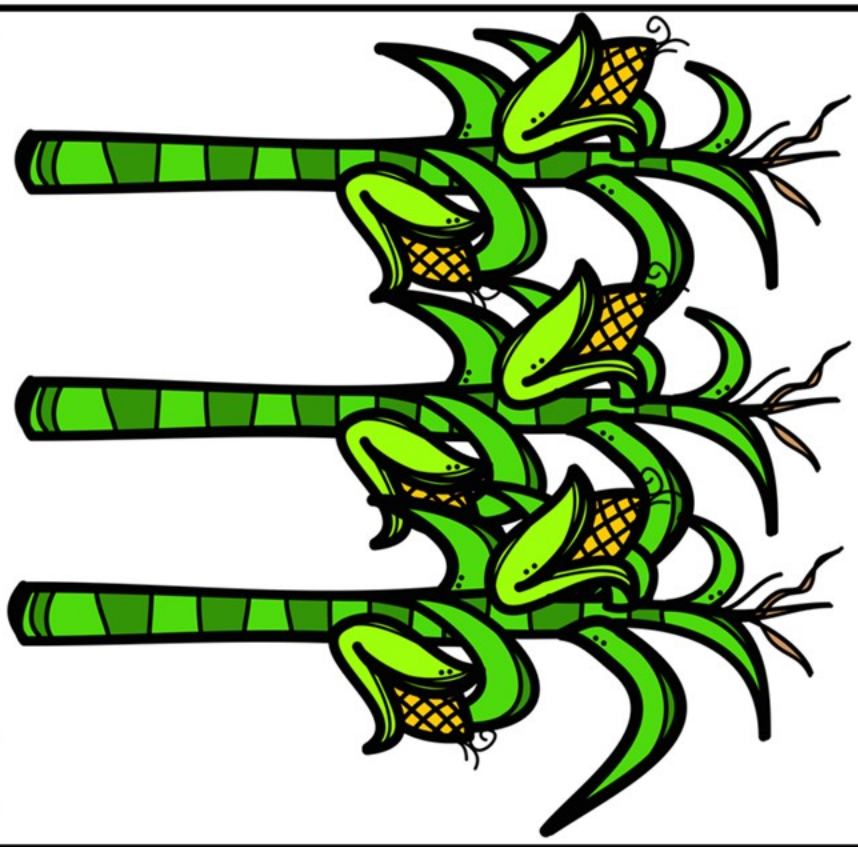

Corn



B & W Posters

Also includes a cover if you want to
make this into a book.

Small version.

Down on the Farm

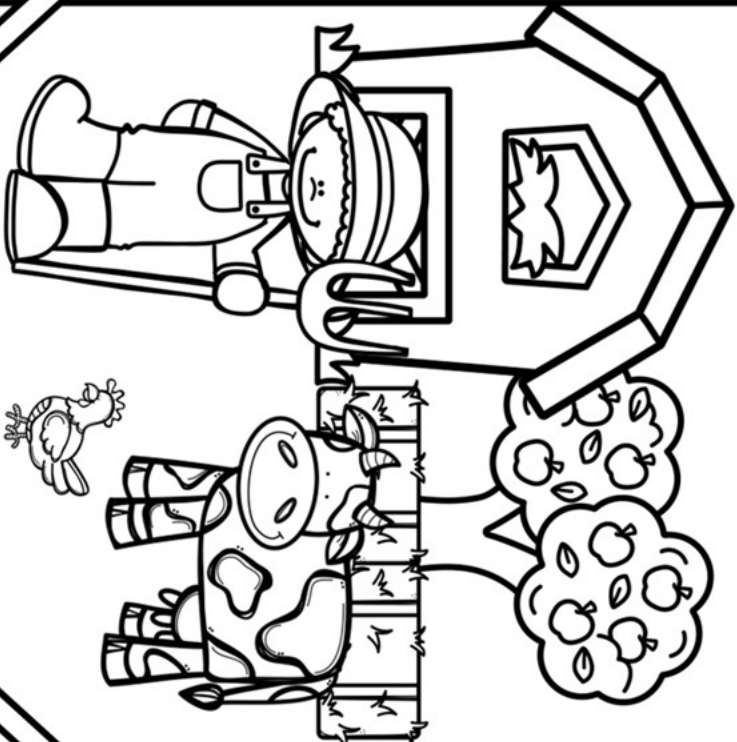

Barn

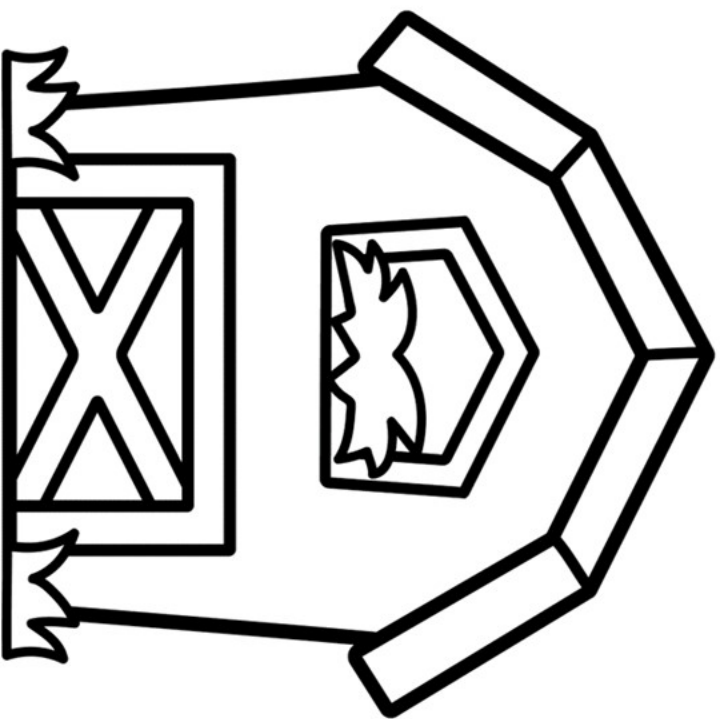

Horse

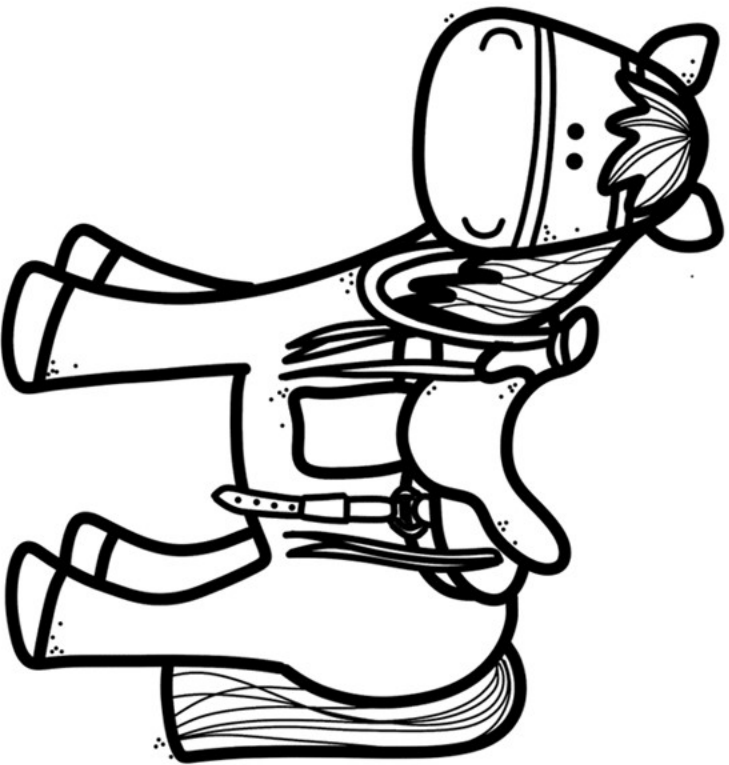

Farmer

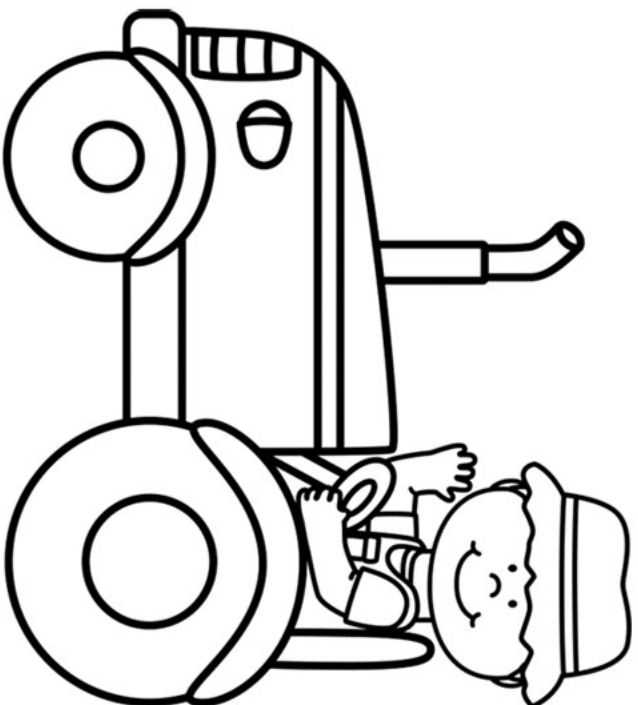

Tractor

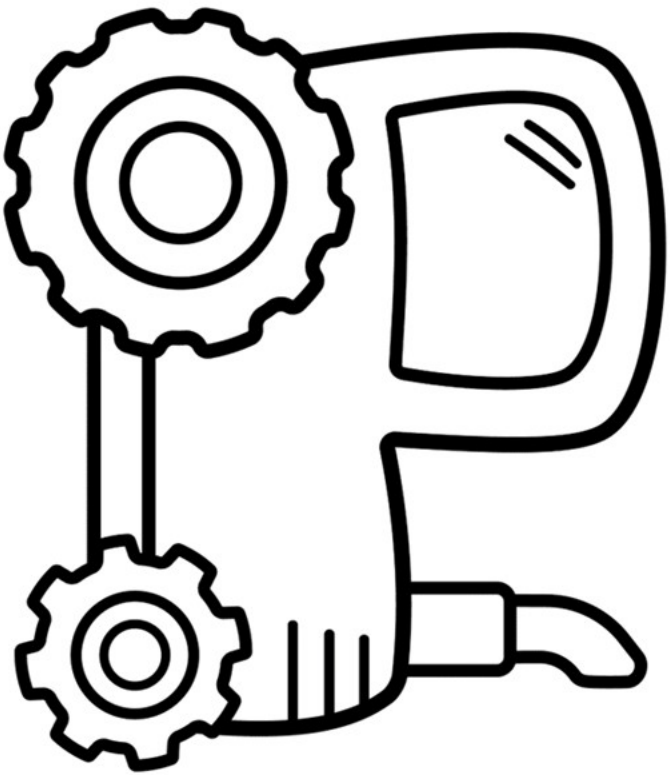

Cow

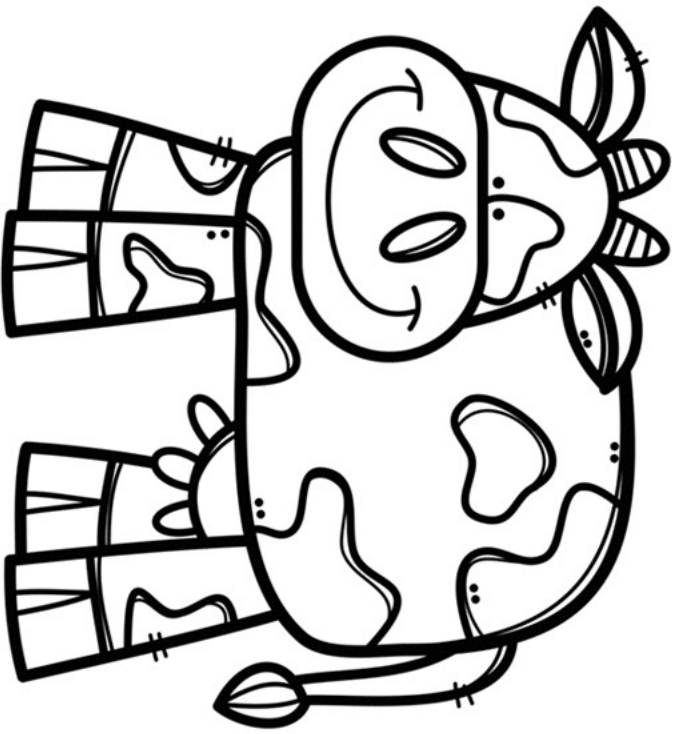

Rooster

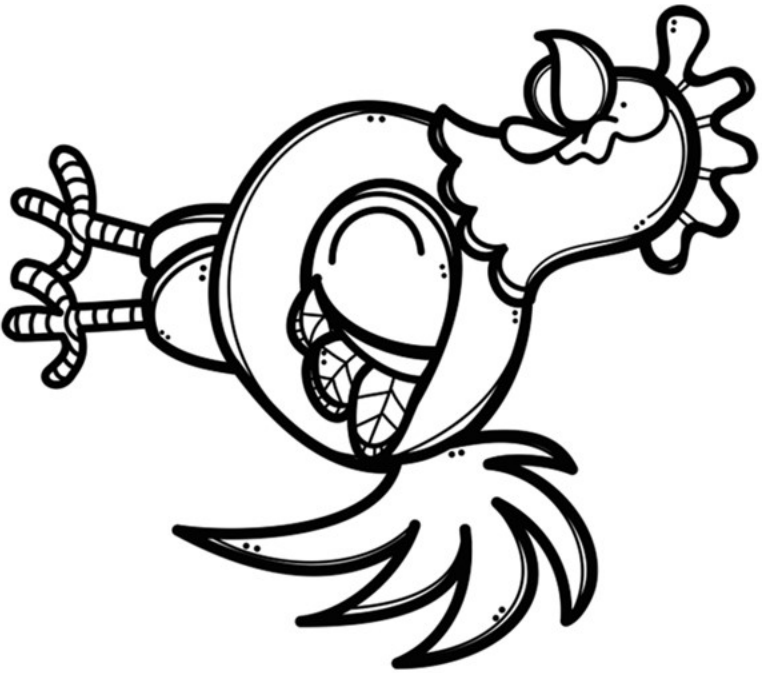

Chick

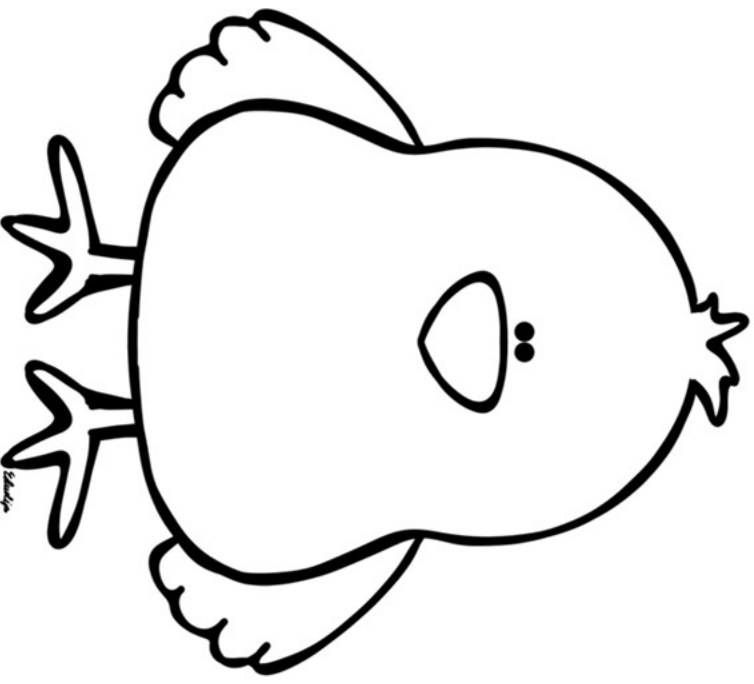

Pig

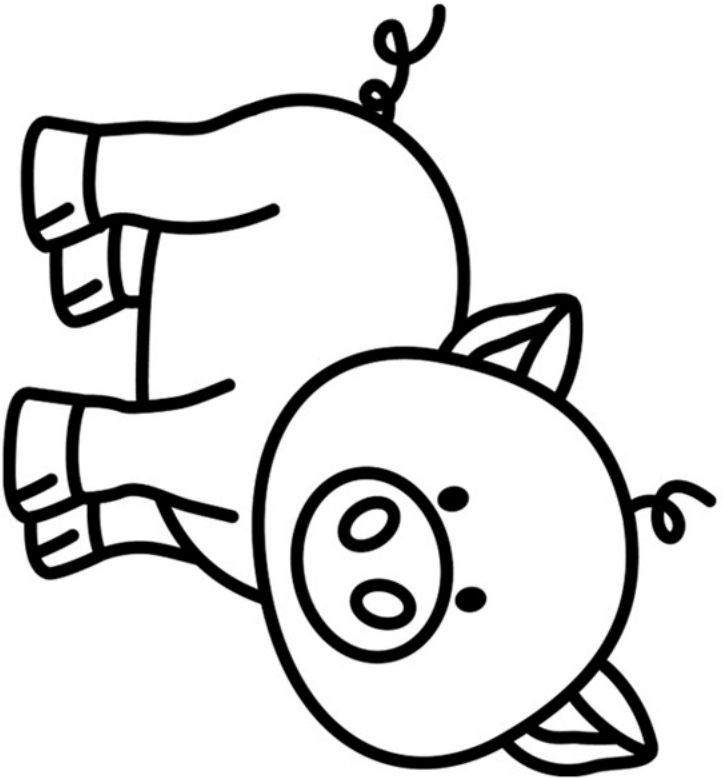

Sheep

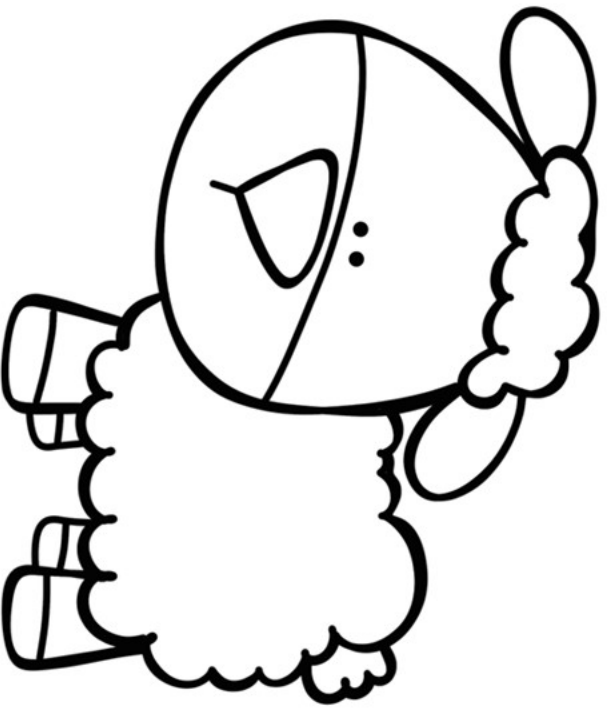

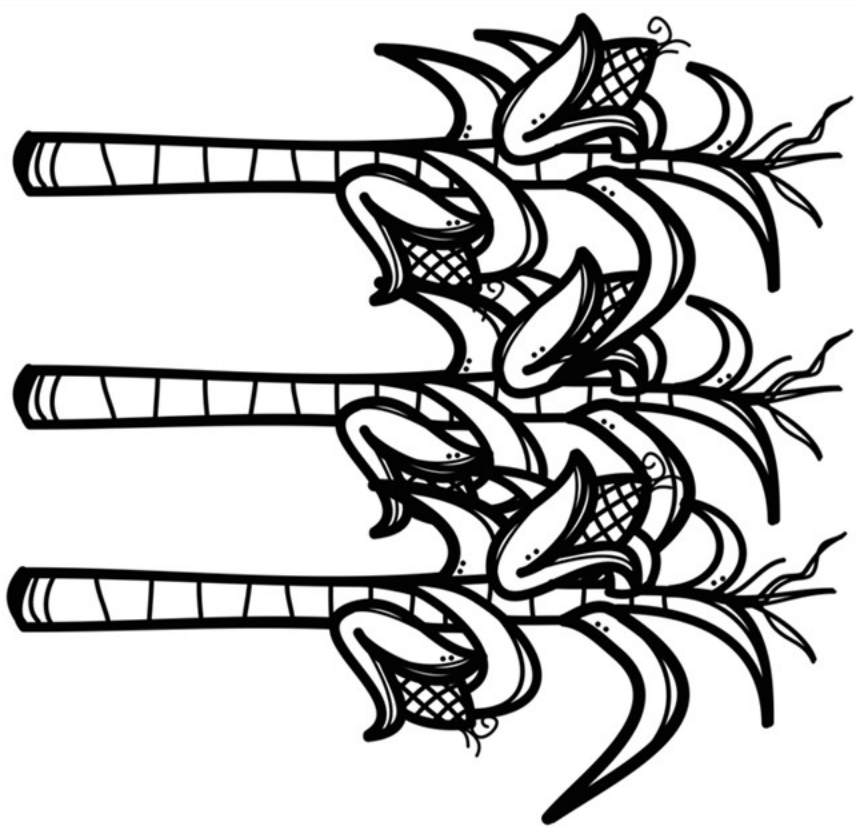

Corn

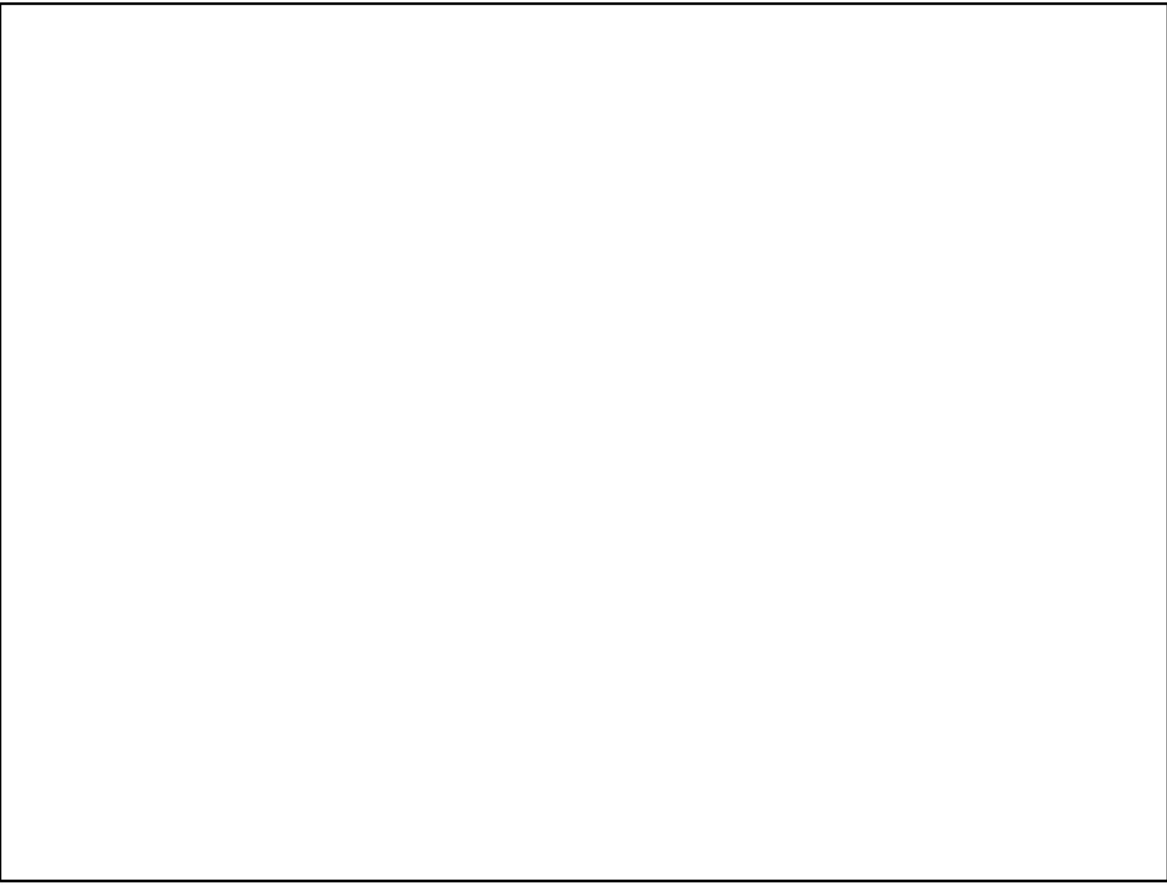

When putting together the down on the farm theme, the following pages show you an example binding the toddler lesson plan.

You can put into the lesson plan the pages you want. Sample shows cover sheet printed on photo quality paper*, and a transparent binding cover. Additional sheets are printed on copy paper 24 lb. You can find items at your local office supply store or purchase directly from Amazon. Click on picture to purchase from Amazon.



Transparent Binding Covers

* You can print the cover up on white card stock, but photo paper gives the cover a brighter color. You are covering with a transparent sheet so it will protect the ink.

Copy Paper 24 lb

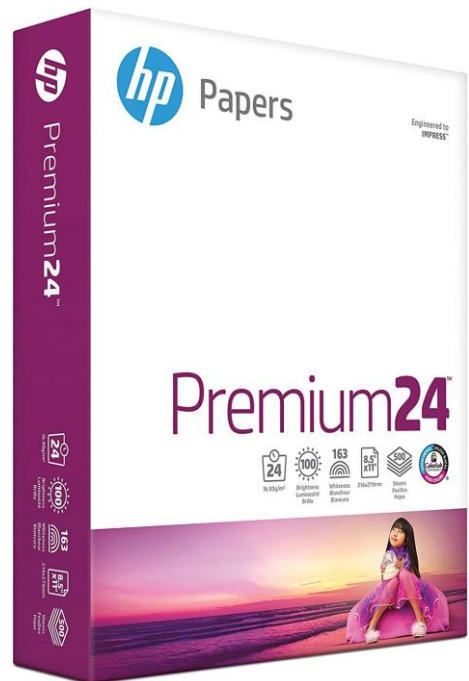

You can bound lesson plan using a binding machine that use coils or combs. Sample shows using coils. You can have this done at a local office supply store or purchase your own to use.

On the following page there are 2 samples of comb or coiled machine you can purchase directly from Amazon or go onto their search bar and type in binding machine.

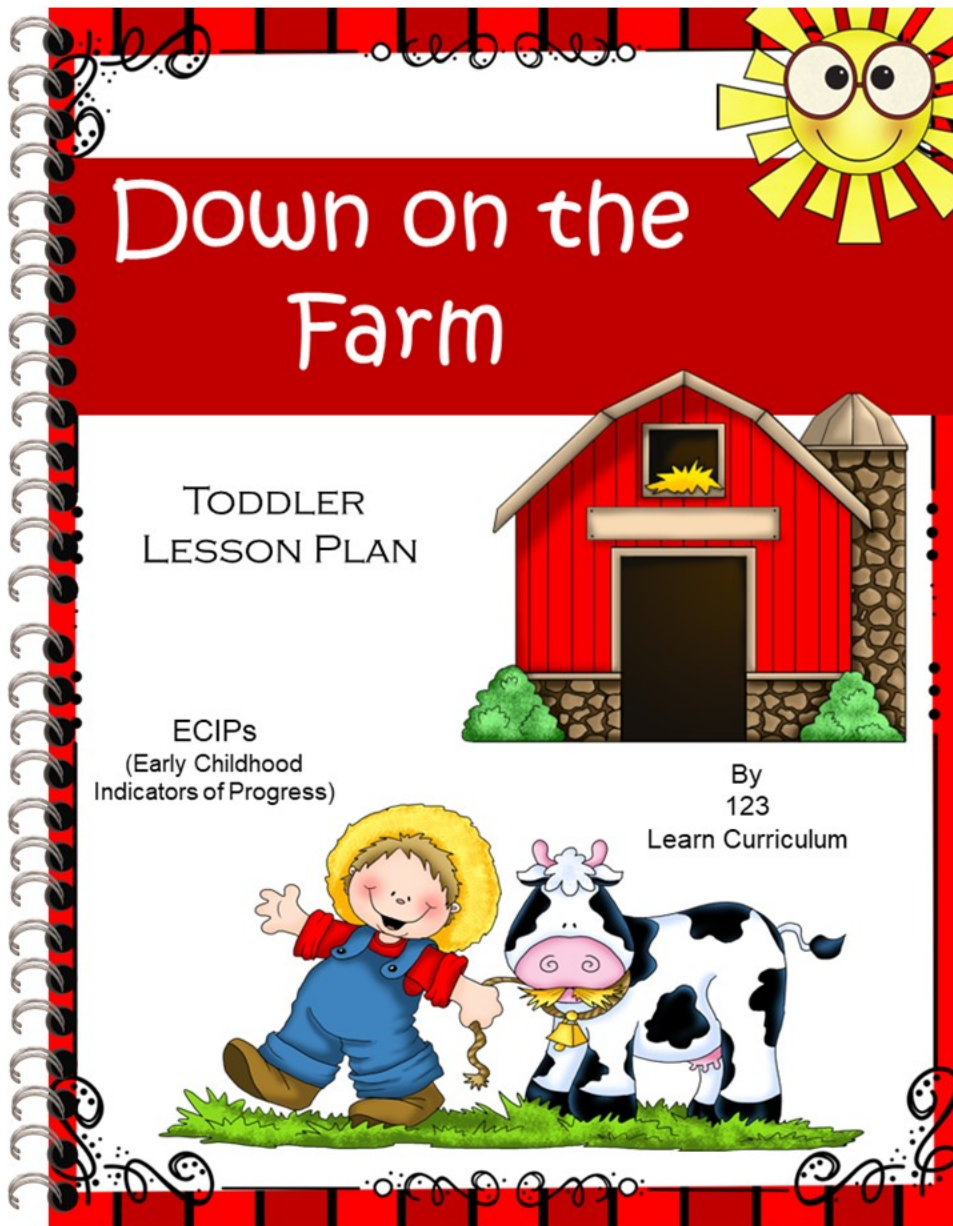

Comb machine
using combs
pictured below.



Coil machine
using coils
pictured below.



Social and Emotional Development
Infants / Toddlers

Domain 1:

Social and Emotional Development

- Trust & Emotional Security
- Self-Awareness
- Relationship with Other Children



Social and Emotional Development ideas. These ideas can be done daily.

- Self-Regulation Greet all children each morning by name and smile.
- During the day take time to hold on lap, and read a book or 2 from the current theme book list.
- When talking with children, make eye contact. Look right into their eyes. When talking encourage them to coo or talk back.
- Talk with children as you go about your day. Tell them what you are doing, what you see. Point things out to them.
- Talk with children, pay attention to their feelings and listen to their coos and words.
- Gently hold and give hugs often.
- Enrich children's daily routines such as mealtime, naps, etc., by sharing looks, smiles, conversations, and stories.
- Attentively respond to children's attempts to communicate with you through facial expressions, gestures, cooing, babbling, and words. Gently mirror their sounds and expressions.
- Take time to follow a child's lead. Join them in floor-time play, and talk with them about their activities whenever possible.
- Gently guide children through social situations: Babies love to look at other babies. Toddlers and preschoolers learn to socialize through practice and experiences that are supported by caring adults.
- Be a positive role model: Offer children opportunities to observe you being a kind and caring person.
- Help children learn a variety of words to fully express their feelings.
- Comment on the positive things that children do.

Group Planning Form

Teacher(s)
Group: Toddlers
Week of:
Theme: Down on the Farm

Changes to Environment: Print up down on the farm posters located in the infant lesson plan. Laminate pictures so that they can be used year after year. Hang pictures down low where toddlers can view. Sit on the floor with infants and talk about the pictures.

Changes to Routines and Schedule: Add items around the playrooms that toddlers can reach and play with. Have board book's theme related for sitting and reading each day. Toddlers LOVE to look at pictures, so make them available. Locate any toys toddlers can play with that are theme related.

Family / Home Connection: Send home themed letter Friday before your down on the farm theme begins. Post on bulletin board cover sheet so parents have a visual what the theme is for next week



Story Time: Barnyard Dance by Sandra Boynton

Moving to Music: I'm a Little Piggy

Sign Language: Cow to sign cow, make your hand into a fist and then straighten your pinkie finger and straighten your thumb. The two extended fingers on your hand should look like the horns of a cow. Take your thumb and put it by the side of your head and twist your hand around. Video: [Cow](#)

TO DO LIST:

Buy: Items needed for toddler area. Additional books, farm toys you want to have available for toddlers. Store in bin for next year's down on the farm theme.

Gather: Any additional supplies for theme.

Other: Go to your local library and get additional books about farms and farm animals. Check the down on the farm list included with this lesson plan. Take time each day to read a book from the down on the farm books you have to toddlers. Check to see ahead of time if your library carries the book for this toddler book choice.

I'm a Little Piggy

(Sung to: "I'm a Little Teapot")



I'm a little piggy,
Short and stout.
Here are my ears,
Here is my snout.

When I see the
Farmer in the dell.
I oink, oink, oink,
And Wiggly my tail!

Monday – Friday

Every morning – greet children by name and with a smile. Have eye contact and show children that you are happy to see them each morning.

Domain: Social and Emotional Development
Component: S6-8: Social Understanding and Relationships

Subcomponent: S6 Social Responsiveness:
 Child notices and responds to others and their emotions

- S6.1** Shows interest or reacts to others' emotions
- S6.2** Responds to others' emotional tone and actions



Spend time reading to children every day. Reading to children set the foundation for later independent reading. Benefits include boosting school readiness - reading is one of the easiest ways to increase school readiness. When you read to children, you're helping to build their vocabulary, language and literacy skills, while improving concentration, curiosity and memory. Research shows that the more words a child is exposed to, the better prepared they are to eventually start reading on their own.

Domain: Language Literacy Communications
Component: LLC 5-13: Emergent Reading
Subcomponent: L4 Motivation, Engagement:
 Child has an interest in and sustained attention for literacy acts

Birth to 5 months:

- L4.1** Likes to be read to and shown pictures
- L4.2** Makes sounds while looking at text or images

6 – 15 months:

- L4.2** Makes sounds while looking at text or images
- L4.3** Points to a few pictures in books and in response to adult question
- L4.4** Demonstrates interest and involvement with books and other print materials

Monday – Friday

Everyday sing or play music for children. You might not have the greatest voice, but children can connect, bond and this is a fun way to interact with all children.

Domain: The Arts
Component: A1-2: Exploring the Arts
Subcomponent: A1

Children shows an interest in learning about different artistic experiences

- A1.1** Actively explores their environment (through song, music, movement, etc.) to enrich their senses.



As you spend each day singing to the children, they are benefiting in so many ways. Having a special song for waking up, and other routine transitions and activities helps them know what comes next.

Language – through your singing, you are introducing a whole new vocabulary. Rhyming songs – children in time will recognize rhymes. Listening skills – like reading, singing is an activity that requires listening. There are so many benefits that you just might want to grab that Mic and go for it. ☺

Domain: Language, Literacy and Communications
Component: LLC 1-2: Listening and Understanding; Receptive Language
Subcomponent: L1 Language Comprehension:

Child understands the meaning of words and phrases (receptive) and uses those words and phrases to communicate effectively (expressive)

- L1.1** Turns toward and focuses on nearby adult caregiver who is speaking
- L1.2** Watches caregiver actions and gestures



Teacher(s) _____ Week of: _____

Group: Toddler Theme: Down on the Farm

123 Learn Curriculum	Monday
Social Emotional	Activity: Self-Regulation. Greet all children each morning by name and smile. Component: Social Understanding and Relationships – S7 Building relationships
Approaches to Learning	Activity: Pig Matching Shapes Component: Initiative and Curiosity – AL1 Inquisitiveness
Language Literacy Communications	Activity: Reading Daily – Dinosaur's Binkit – Plus other assorted theme related infant books. Component: Emergent Reading – L4 Motivation, engagement
The Arts	Activity: Singing or music playing daily Component: Exploring the Arts – A1
Social Systems Cognitive	Activity: Component:
Physical & Movement	Activity: Pig Corraling Component: P1.4: Gross Motor
Mathematics Cognitive	Activity: Component:
Scientific Thinking Cognitive	Activity: Component:

Monday
Pig Matching Shapes
 Activity for 1 or more toddlers
 Duration of activity: 10 – 15 minutes

Skill activity supports: Social and emotional development, small motor.

Domain: Social and Emotional Development
Component: S6-8: Social Understanding and Relationships
Subcomponent: S7 Building Relationships
 Child establishes and sustains relationships with others

- S7.1** Shows a preference for a trusted adult
- S7.2** Notices or responds to others

Domain: Approaches to Learning
Component: AL1-2 Initiative and Curiosity
Subcomponent: AL1 Inquisitiveness

Child explores the environment and seeks interaction with people and objects; willingly tries new things

- AL1.4** Uses senses to explore their environment
- AL1.5** Seeks and taking pleasure in new skills

Materials needed:

- Pig matching cards printed up on white card stock
- Crayons or markers if printing up b & w set
- Laminating sheets
- Scissors

Directions: Print up the pig matching shape sheets onto white card stock. You have the option of printing color or b & w and coloring yourself to save on ink. Print up 2 sheets per page. Trim the cards and laminate if desired. Laminating will make cards last longer.

Sit with toddlers at a table and lay out the cards. Show them that they have pigs on the cards, and each card has a shape. See if you can match the color and shape of each pig card.

Talk to them about the different shapes and tell them what shapes they are if they don't know and what color they are. A fun way to incorporate colors and shapes with your toddlers.

Print the following cover
on white card stock.



Down on the Farm

TODDLER
LESSON PLAN



ECIPs
(Early Childhood
Indicators of Progress)

By
123
Learn Curriculum



Social and Emotional Development

Infants / Toddlers

Domain 1:

Social and Emotional Development

- Trust & Emotional Security
- Self-Awareness
- Relationship with Other Children



Social and Emotional Development ideas. These ideas can be done daily.

- Self-Regulation Greet all children each morning by name and smile.
- During the day take time to hold on lap, and read a book or 2 from the current theme book list.
- When talking with children, make eye contact. Look right into their eyes. When talking encourage them to coo or talk back.
- Talk with children as you go about your day. Tell them what you are doing, what you see. Point things out to them.
- Talk with children, pay attention to their feelings and listen to their coos and words.
- Gently hold and give hugs often.
- Enrich children's daily routines such as mealtime, naps, etc., by sharing looks, smiles, conversations, and stories.
- Attentively respond to children's attempts to communicate with you through facial expressions, gestures, cooing, babbling, and words. Gently mirror their sounds and expressions.
- Take time to follow a child's lead. Join them in floor-time play, and talk with them about their activities whenever possible.
- Gently guide children through social situations: Babies love to look at other babies. Toddlers and preschoolers learn to socialize through practice and experiences that are supported by caring adults.
- Be a positive role model: Offer children opportunities to observe you being a kind and caring person.
- Help children learn a variety of words to fully express their feelings.
- Comment on the positive things that children do.

Group Planning Form

Teacher(s)

Group: Toddlers

Week of:

Theme: Down on the Farm

Changes to Environment: Print up down on the farm posters located in the infant lesson plan. Laminate pictures so that they can be used year after year. Hang pictures down low where toddlers can view. Sit on the floor with infants and talk about the pictures.

Changes to Routines and Schedule: Add items around the playrooms that toddlers can reach and play with. Have board book's theme related for sitting and reading each day. Toddlers LOVE to look at pictures, so make them available. Locate any toys toddlers can play with that are theme related.

Family / Home Connection: Send home themed letter Friday before your down on the farm theme begins. Post on bulletin board cover sheet so parents have a visual what the theme is for next week



Story Time: Barnyard Dance by Sandra Boynton

Moving to Music: I'm a Little Piggy

Sign Language: **Cow** to sign cow, make your hand into a fist and then straighten your pinkie finger and straighten your thumb. The two extended fingers on your hand should look like the horns of a cow. Take your thumb and put it by the side of your head and twist your hand around. Video: [Cow](#)

TO DO LIST:

Buy: Items needed for toddler area. Additional books, farm toys you want to have available for toddlers. Store in bin for next year's down on the farm theme.

Gather: Any additional supplies for theme.

Other: Go to your local library and get additional books about farms and farm animals. Check the down on the farm list included with this lesson plan. Take time each day to read a book from the down on the farm books you have to toddlers. Check to see ahead of time if your library carries the book for this toddler book choice.

Blank Weekly Toddler Lesson Plan

Print up and fill out if you want to do your own lesson plan.

Teacher (s) _____

Week of: _____

Group: Toddler

Theme: Down on the Farm

123 Learn Curriculum	Monday	Tuesday	Wednesday	Thursday	Friday
Social Emotional	Activity:	Activity:	Activity:	Activity:	Activity:
	Component:	Component:	Component:	Component:	Component:
Approaches to Learning	Activity:	Activity:	Activity:	Activity:	Activity:
	Component:	Component:	Component:	Component:	Component:
Language Literacy Communications	Activity:	Activity:	Activity:	Activity:	Activity:
	Component:	Component:	Component:	Component:	Component:
The Arts	Activity:	Activity:	Activity:	Activity:	Activity:
	Component:	Component:	Component:	Component:	Component:
Social Systems Cognitive	Activity:	Activity:	Activity:	Activity:	Activity:
	Component:	Component:	Component:	Component:	Component:
Physical & Movement	Activity:	Activity:	Activity:	Activity:	Activity:
	Component:	Component:	Component:	Component:	Component:
Mathematics Cognitive	Activity:	Activity:	Activity:	Activity:	Activity:
	Component:	Component:	Component:	Component:	Component:
Scientific Thinking Cognitive	Activity:	Activity:	Activity:	Activity:	Activity:
	Component:	Component:	Component:	Component:	Component:

Teacher (s) _____

Week of: _____

Group: Toddler

Theme: Down on the Farm

123 Learn Curriculum	Monday	Tuesday	Wednesday	Thursday	Friday
Social Emotional	Activity: Greet all children each morning by name and smile.	Activity: Talk to children as you go about your day. Tell them what you are doing, what you see. Point things out to them.	Activity: When talking with children, make eye contact. Look right into their eyes. When talking encourage them to coo or talk back.	Activity: Be a positive role model: Offer children opportunities to observe you being a kind and caring person.	Activity: Help children learn a variety of words to fully express their feelings.
	Component: S 6-8: Social Understanding and Relationships	Component: S 6-8: Social Understanding and Relationships	Component: S 6-8: Social Understanding and Relationships	Component: S 6-8: Social Understanding and Relationships	Component: S 6-8: Social Understanding and Relationships
Approaches to Learning	Activity: Pig Matching Shapes	Activity: Farm Clothes Pin Counting	Activity: Farm Shape Match Cards	Activity: Shape and Color Match Cards	Activity: Farm Match
	Component: AL1 Inquisitiveness	Component: AL10-13 Processing and Utilizing Info.	Component: AL1 Initiative and Curiosity	Component: AL-1 Initiative and Curiosity	Component: AL1 – Initiative and Curiosity
Language Literacy Communications	Activity: Reading Daily – Barnyard Dance – Plus other books.	→	→	→	→
	Component: LLC 5-13: Emergent Reading	Component: LLC 5-13: Emergent Reading	Component: LLC 5-13: Emergent Reading	Component: LLC 5-13: Emergent Reading	Component: LLC 5-13: Emergent Reading
The Arts	Activity: Singing or music daily	→	→	→	→
	Component: A1-2: Exploring the Arts	Component: A1-2: Exploring the Arts	Component: A1-2: Exploring the Arts	Component: A1-2: Exploring the Arts	Component: A1-2: Exploring the Arts
Social Systems Cognitive	Activity:	Activity:	Activity:	Activity:	Activity:
	Component:	Component:	Component:	Component:	Component:
Physical & Movement	Activity: Pig Corralling	Activity: Farm Dauber Painting	Activity: Farm Movement Cards	Activity: Pipe Cleaning Sculptures	Activity: Farm Playdough Mats
	Component: P5-6: Fine Motor	Component: P5-6: Fine Motor	Component: P5-6 Fine Motor	Component: P5-6: Fine Motor	Component: P5-6 Fine Motor
Mathematics Cognitive	Activity:	Activity:	Activity:	Activity:	Activity:
	Component:	Component:	Component:	Component:	Component:
Scientific Thinking Cognitive	Activity:	Activity:	Activity:	Activity:	Activity:
	Component:	Component:	Component:	Component:	Component:

Toddler Book Choice

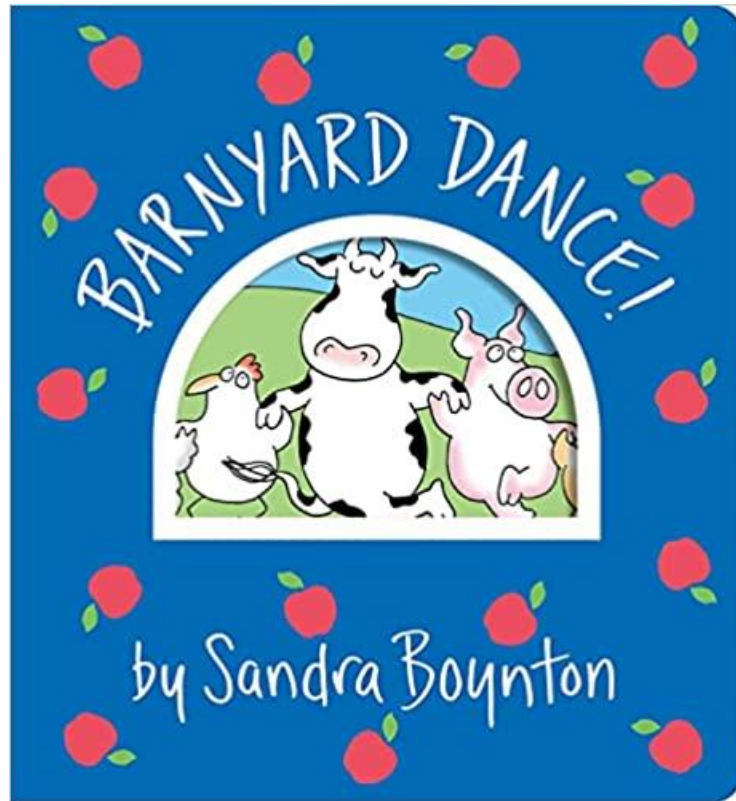

Barnyard Dance By Sandra Boynton

Click on picture above to go to Amazon.com to purchase book.

Once you click on book, click on allow and you will be taken directly to the book to purchase.

You can also check your local library to see if they have a copy.

I'm a Little Piggy

(Sung to: "I'm a Little Tea Pot")



I'm a little piggy,
Short and stout.
Here are my ears,
Here is my snout.

When I see the
Farmer in the dell.
I oink, oink, oink,
And wiggly my tail!

Cow sign language poster used with permission from
Baby Sign Language.

To purchase any sign language materials, please visit
Baby Sign Language @
<https://www.babysignlanguage.com/>

To view video for signing gift,
click on the link below:
<https://www.babysignlanguage.com/dictionary/c/cow/>

Cow



Signing: To make the sign for cow, make your hand into a fist then straighten your pinkie finger and straighten your thumb. The two extended fingers on your hand should look like the horns of a cow. Take your thumb and put it by the side of your head and twist your hand around.

Monday – Friday

Every morning – greet children by name and with a smile. Have eye contact and show children that you are happy to see them each morning.

Domain: Social and Emotional Development
Component: S6-8: Social Understanding and Relationships

Subcomponent: S6 Social Responsiveness:

Child notices and responds to others and their emotions

S6.3 Imitates others' emotions and expressions

S6.4 Shows some individual response to others' emotional tone



Spend time reading to children every day. Reading to children set the foundation for later independent reading. Benefits include boosting school readiness - reading is one of the easiest ways to increase school readiness. When you read to children, you're helping to build their vocabulary, language and literacy skills, while improving concentration, curiosity and memory. Research shows that the more words a child is exposed to, the better prepared they are to eventually start reading on their own.

Domain: Language Literacy Communications

Component: L4-8: Emergent Reading

Subcomponent: L4 Motivation, Engagement:

Child has an interest in and sustained attention for literacy acts

6 – 15 months:

L4.2 Makes sounds while looking at text or images

L4.3 Points to a few pictures in books and in response to adult question

L4.4 Demonstrates interest and involvement with books and other print materials

15 – 24 months:

L4.5 Relates an object in a book or print to the real object

L4.6 Imitates reading

Monday – Friday

Everyday sing or play music for children. You might not have the greatest voice, but children can connect, bond and this is a fun way to interact with all children.

Domain: The Arts

Component: A1-2: Exploring the Arts

Subcomponent: A1 Interest in Art:

Children shows an interest in learning about different artistic experiences

A1.2 Begins to choose senses to explore



As you spend each day singing to the children, they are benefiting in so many ways. Having a special song for waking up, and other routine transitions and activities helps them know what comes next.

Language – through your singing, you are introducing a whole new vocabulary. Rhyming songs – children in time will recognize rhymes. Listening skills – like reading, singing is an activity that requires listening. There are so many benefits that you just might want to grab that Mic and go for it. 😊

Domain: Language, Literacy and Communications

Component: LLC 1-2: Listening and Understanding; Receptive Language

Subcomponent: L1 Language Comprehension:

Child understands the meaning of words and phrases (receptive) and uses those words and phrases to communicate effectively (expressive)

L1.3 Responds to nonverbal and verbal cues

L1.4 Responds to conversation, questions, and requests



Teacher (s) _____ Week of: _____

Group: Toddler

Theme: Down on the Farm

<p>123 Learn Curriculum</p>	<p>Monday</p>
<p>Social Emotional</p>	<p>Activity: Self-Regulation Greet all children each morning by name and smile.</p>
	<p>Component: Social Understanding and Relationships – S7 Building relationships</p>
<p>Approaches to Learning</p>	<p>Activity: Pig Matching Shapes</p>
	<p>Component: Initiative and Curiosity – AL1 Inquisitiveness</p>
<p>Language Literacy Communications</p>	<p>Activity: Reading Daily: Barnyard Dance – Plus other assorted theme related books.</p>
	<p>Component: Emergent Reading – L4 Motivation, engagement</p>
<p>The Arts</p>	<p>Activity: Singing or music playing daily</p>
	<p>Component: Exploring the Arts – A1</p>
<p>Social Systems Cognitive</p>	<p>Activity:</p>
	<p>Component:</p>
<p>Physical & Movement</p>	<p>Activity: Pig Corralling</p>
	<p>Component: P1.4: Gross Motor</p>
<p>Mathematics Cognitive</p>	<p>Activity:</p>
	<p>Component:</p>
<p>Scientific Thinking Cognitive</p>	<p>Activity:</p>
	<p>Component:</p>

Monday

Pig Matching Shapes

Activity for 1 or more toddler

Duration of activity: 10 – 15 minutes

Skill activity supports social and emotional development, small motor

Domain: Social and Emotional Development

Component: S1-3: Self and Emotional Awareness

Subcomponent: SE 1 Confidence

Child demonstrates confidence “I am capable, I can experiment, I can make mistakes, and I can move on”

S1.3 Independently attempts new challenges or activities that may or not be successful

S1.4 Checks with and accepts support from adult or caregiver when necessary

Domain: Approaches to Learning

Component: AL1-2: Initiative and Curiosity

Subcomponent: AL1: Inquisitiveness

Child explores the environment and seeks interaction with people and objects; willingly tries new things

AL1.4 Uses senses to explore their environment

AL1.5 Seeks and taking pleasure in new skills

Materials needed:

- Pig matching cards printed up on white card stock
- Crayons or markers if printing up b & w set
- Laminating sheets
- Scissors

Directions: Print up the pig matching shape sheets onto white card stock. You have the option of printing color or b & w and coloring yourself to save on ink. Print up 2 sheets per page.

Trim the cards and laminate if desired. Laminating will make cards last longer.

Sit with toddlers at a table and lay out the cards. Show them that they have pigs on the cards, and each card has a shape. See if they can match the color and shape of each pig card.

Talk to them about the different shapes and tell them what shape they are if they are having problems and what color they are. A fun way to incorporate colors and shapes with your toddlers.

Pig Matching Shapes

- Print up 2 copies, cut out and laminate.
- Have children match the shapes.
- You can also leave 1 sheet as a full sheet and have child place the matching card on top.

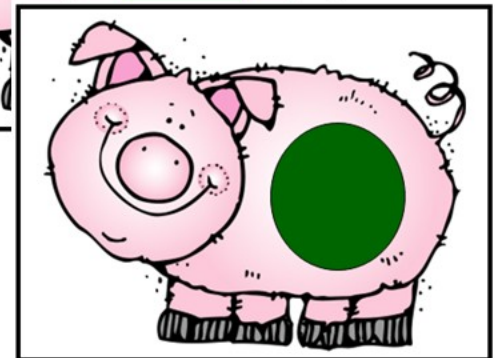
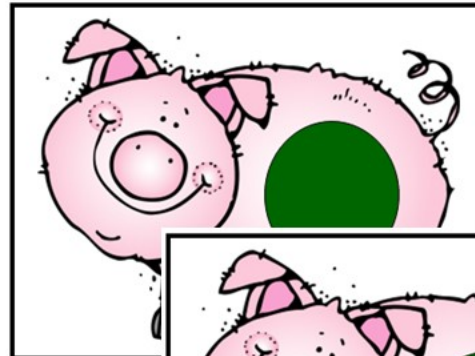
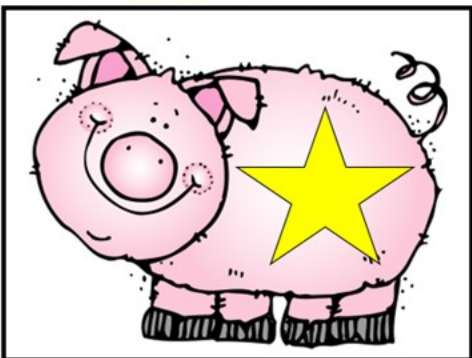
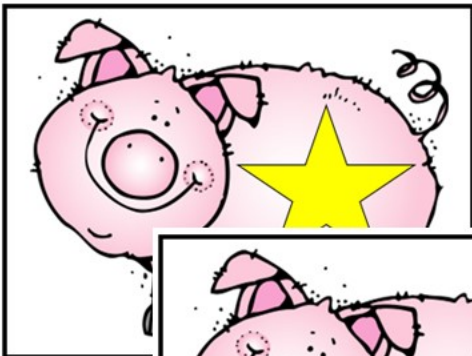
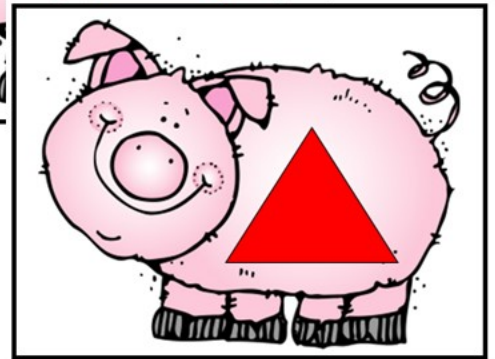
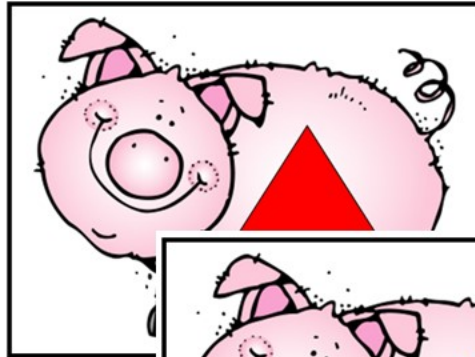
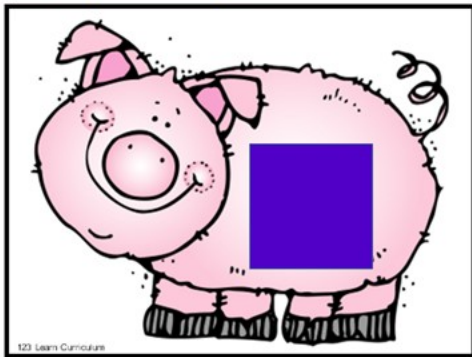
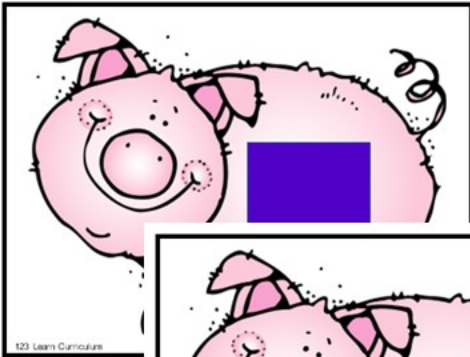

Pig Matching Cards

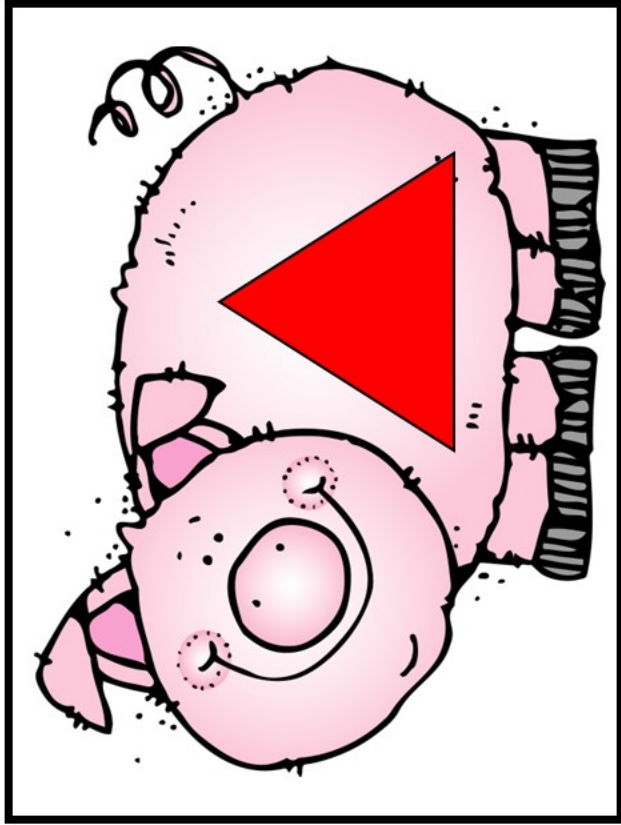
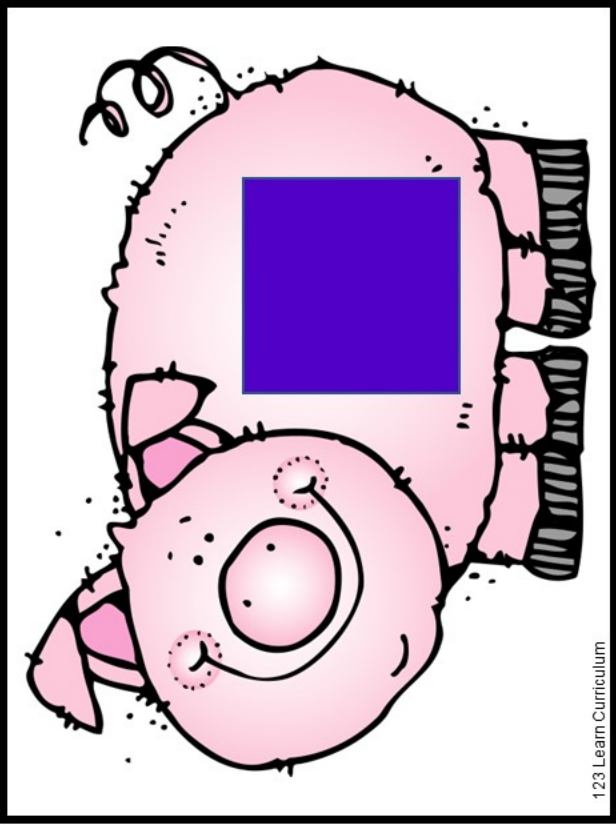
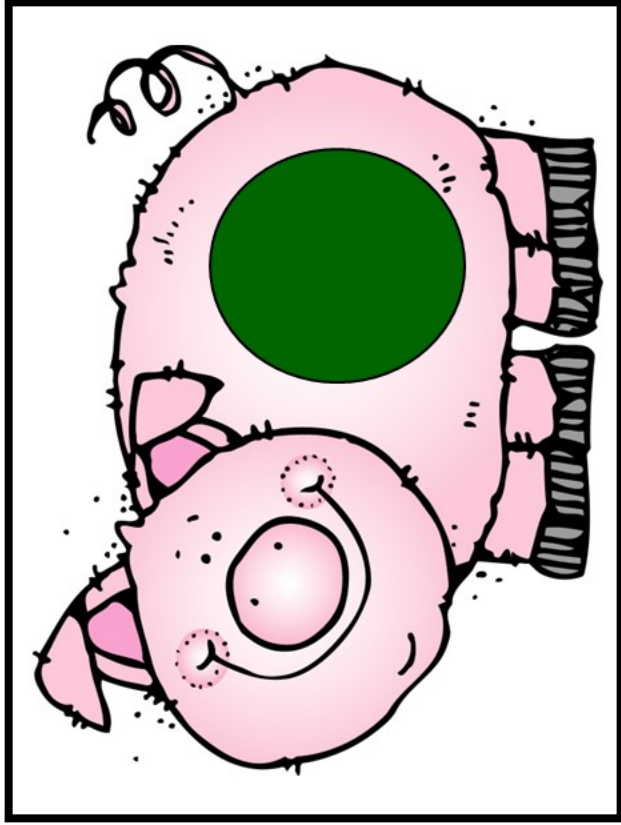
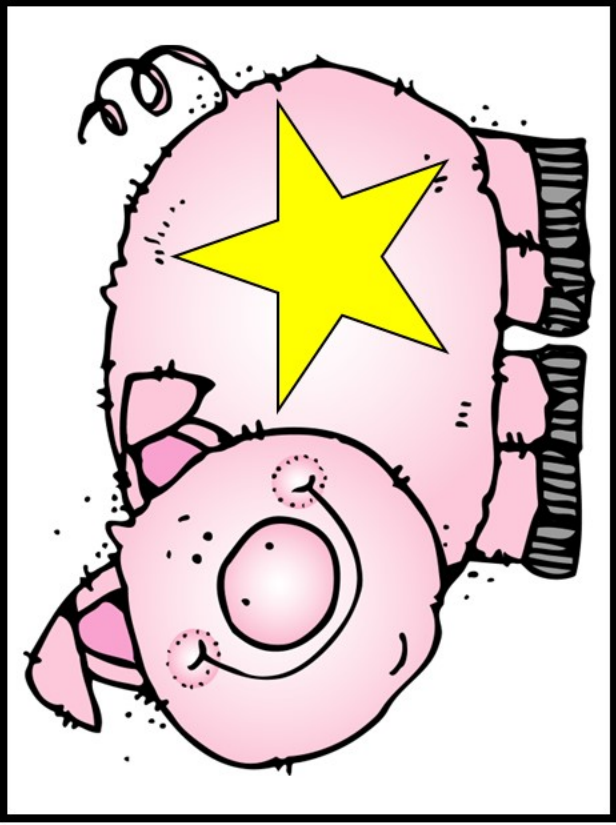

Pig Matching Cards

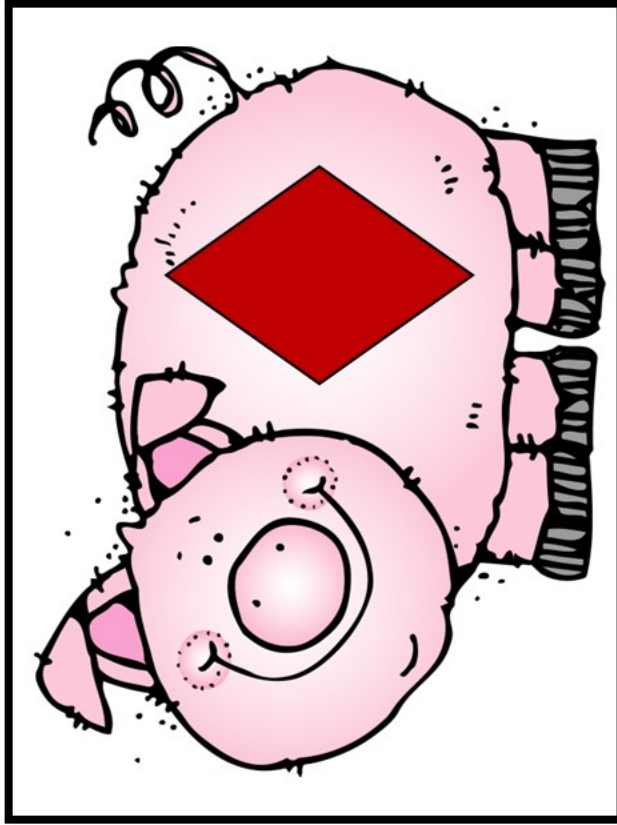
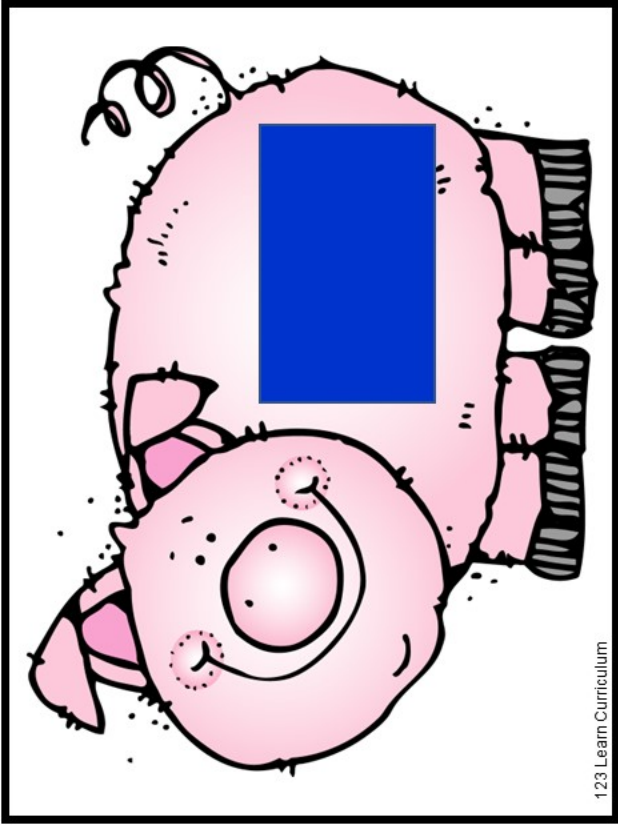
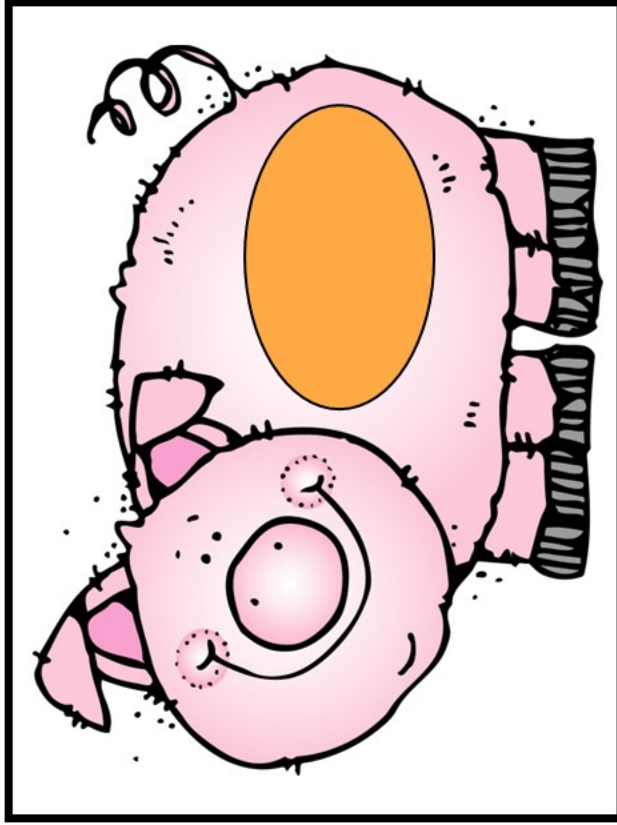
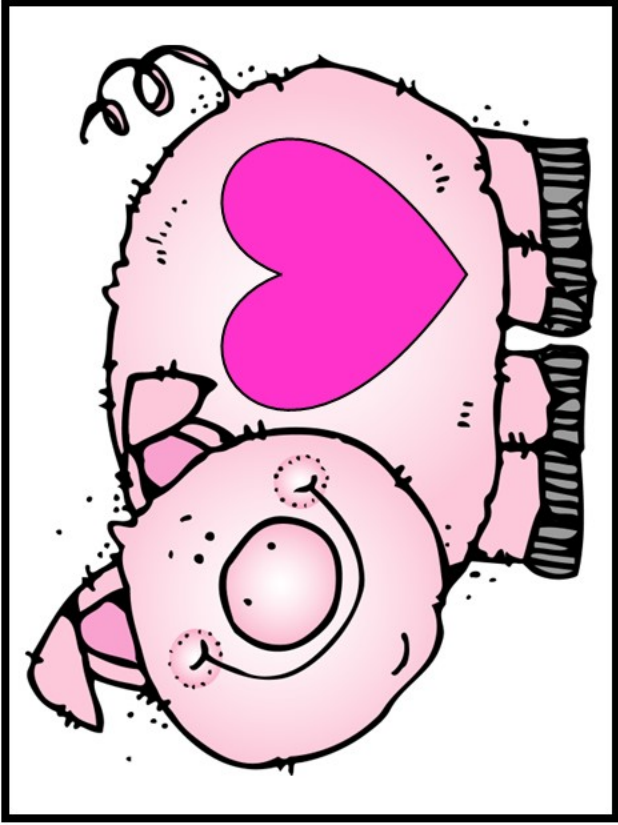

Pig Matching Cards

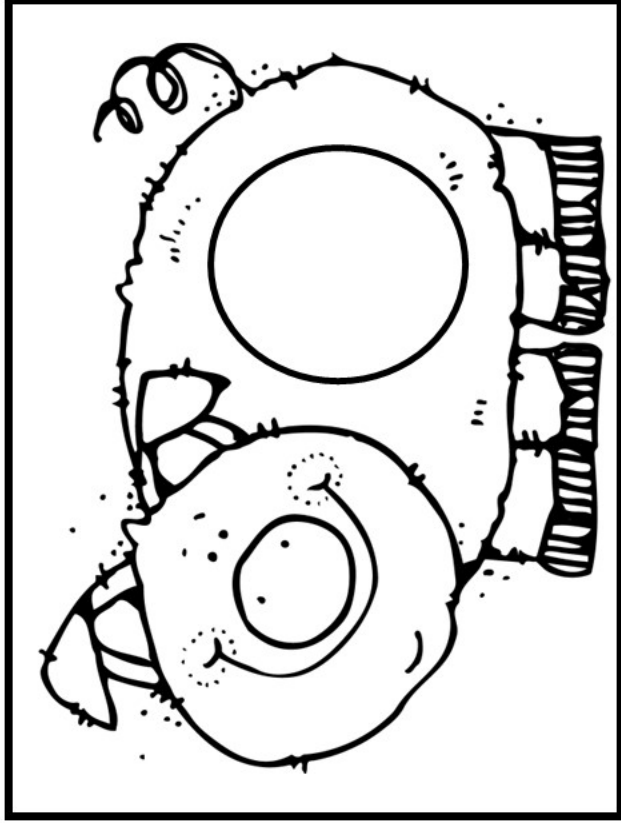
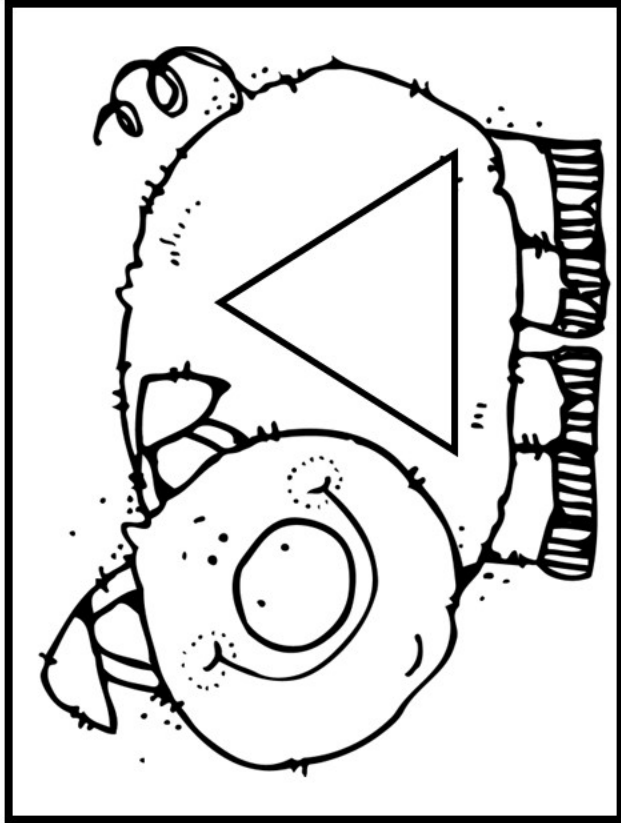
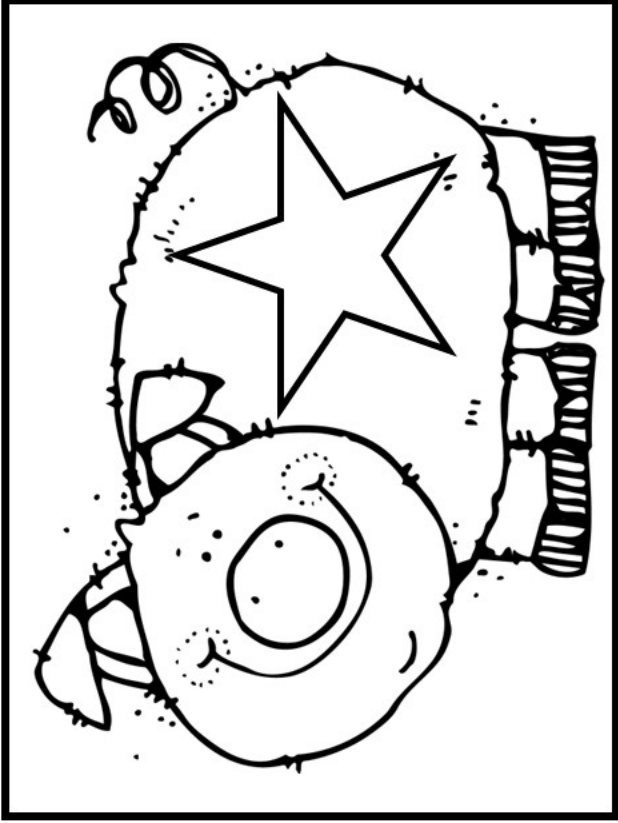
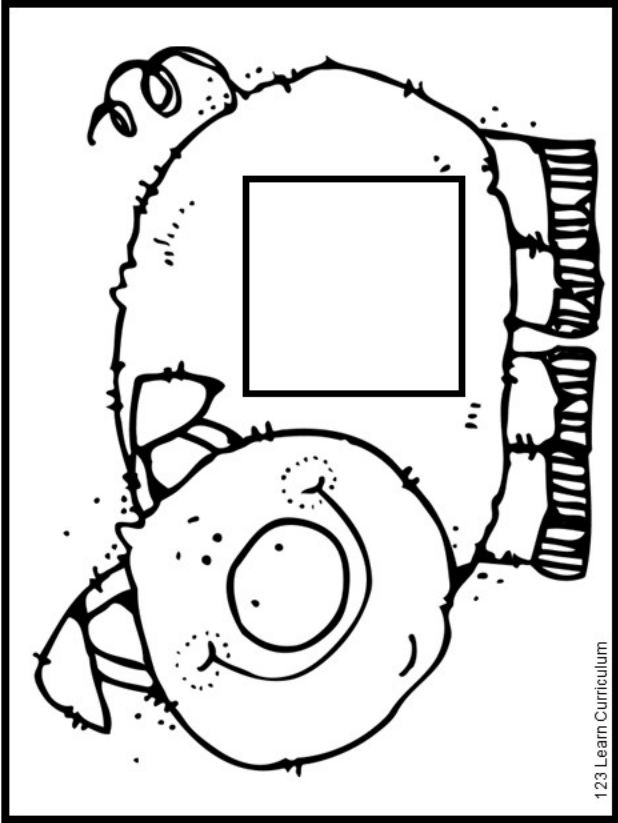

Pig Matching Cards

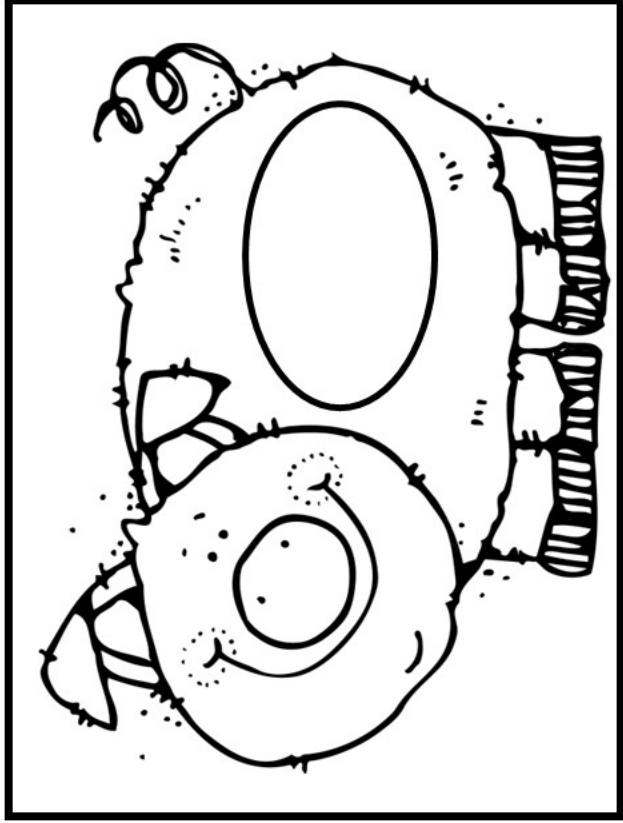
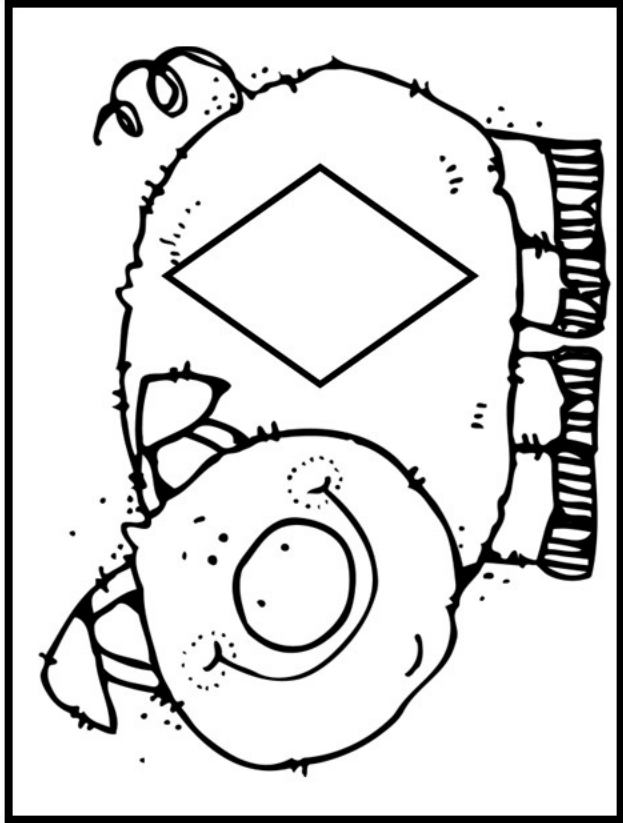
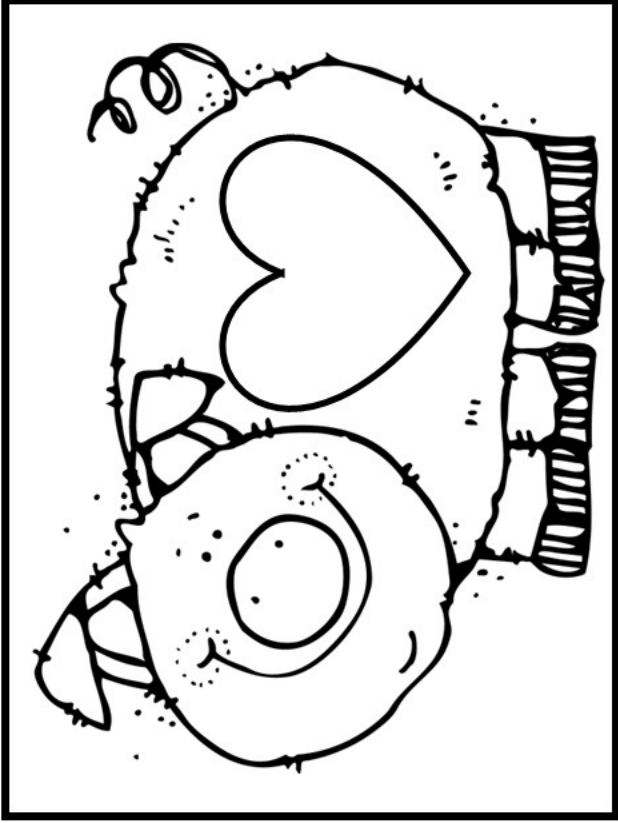
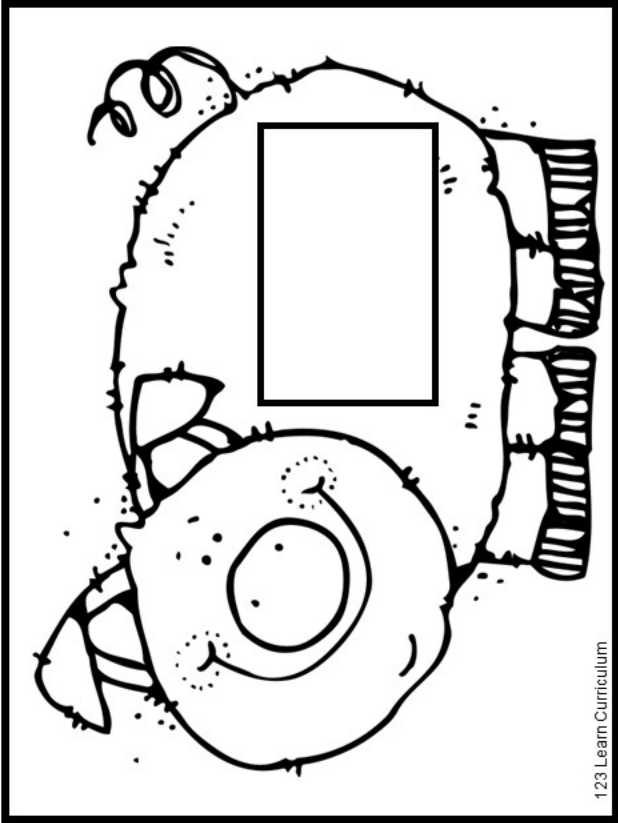

Monday

Pig Corralling

Activity for 1 or more Toddler

Duration of activity: 10 – 15 minutes

A fun activity to get toddlers burning off some energy and working their large muscles. Skill activity supports language, cognitive and large motor skills

Domain: Language, Literacy and Communications: Cognitive

Component: LLC 3-4: Listening and Understanding; Receptive Language

Subcomponent: L2 Social conversation: Child meaningfully engages in talk

L2.3 Uses sounds, gestures, or actions to communicate

L2.5 Uses real or made-up words or signs to express

Domain: Physical and Movement Development

Component: P1-4: Gross Motor

Subcomponent: P3 Locomotion: Childs moves their body through space from one space to another

P3.7 Runs freely

Materials needed:

- Pink balloons blown up and knotted
- Plastic kids rake (1 per child – check your local dollar store)
- Big play area (inside or outside)

Directions: Blow up 7 – 10 balloons for the children and tie them close. Make them at least 6 – 8 inches big so they can hit them easily. (Draw a pig face on each balloon – eyes, nose and a smile). Tell toddlers you're going to have them corral the piggies into the pig pin.

Have an area that you want to use as the pig pin, either a basket or large box laid on its side. Tell toddlers to take their rake and gently hit the piggies into the box/es. Watch them carefully so the rake swinging doesn't get too wild.

Teacher (s) _____ Week of: _____

Group: Toddlers

Theme: Down on the Farm

<p>123 Learn Curriculum</p>	<p>Tuesday</p>
<p>Social Emotional</p>	<p>Activity: Talk to children as you go about your day. Tell them what you are doing, what you see. Point things out to them.</p>
	<p>Component: Social Understanding and Relationships – S7 Building relationships</p>
<p>Approaches to Learning</p>	<p>Activity: Farm Clothes Pin Counting</p>
	<p>Component: AL10-13 Processing and Utilizing Information</p>
<p>Language Literacy Communications</p>	<p>Activity: Reading Daily: Barnyard Dance – Plus other assorted theme related books.</p>
	<p>Component: Emergent Reading – L4 Motivation, engagement</p>
<p>The Arts</p>	<p>Activity: Singing or music playing daily</p>
	<p>Component: Exploring the Arts – A1</p>
<p>Social Systems Cognitive</p>	<p>Activity:</p>
	<p>Component:</p>
<p>Physical & Movement</p>	<p>Activity: Farm Dauber Painting</p>
	<p>Component: P5-6: Fine Motor</p>
<p>Mathematics Cognitive</p>	<p>Activity:</p>
	<p>Component:</p>
<p>Scientific Thinking Cognitive</p>	<p>Activity:</p>
	<p>Component:</p>

Tuesday

Farm Clothes Pin Counting

Activity for 1 or more Toddlers

Duration of activity: 5 – 10 minutes

Domain: Approaches to Learning

Component: AL10-13 Processing and Utilizing Information

Subcomponent: AL10 Working Memory

Child stores and retrieves information in order to use it purposely

AL10-2 Uses some prior experiences to build new knowledge and solve problems

Domain: Physical and Movement Development

Component: P5-6: Fine Motor

Subcomponent P5 Dexterity: Child can coordinate and control movement of hands and fingers to grasp and manipulate objects

P5.3 Transfers object from one hand to another hand

Domain: Mathematics - Cognitive

Component: M1-6 Number Knowledge

Subcomponent: M1 Rote Counting: The child attends to sequences and use of number words, with or without items, sets, or numbers and without recognizing the link to quantity.

M1.3 Imitates use of at least one number word

Materials:

- Small Basket
- Clothes pins
- White cardstock
- Number card template
- Laminating sheets
- Scissors



Tuesday

Farm Clothes Pin Counting

Activity for 1 or more Toddlers

Duration of activity: 5 – 10 minutes

Directions:

Print up the following farm sheets onto white cardstock. Laminate and cut out.

Sit at the table with toddlers, give them a farm card, talk to them about the number on the card and how many clothes pins they will need to put onto the farm card. Talk to them about the color of the clothespins they're using.

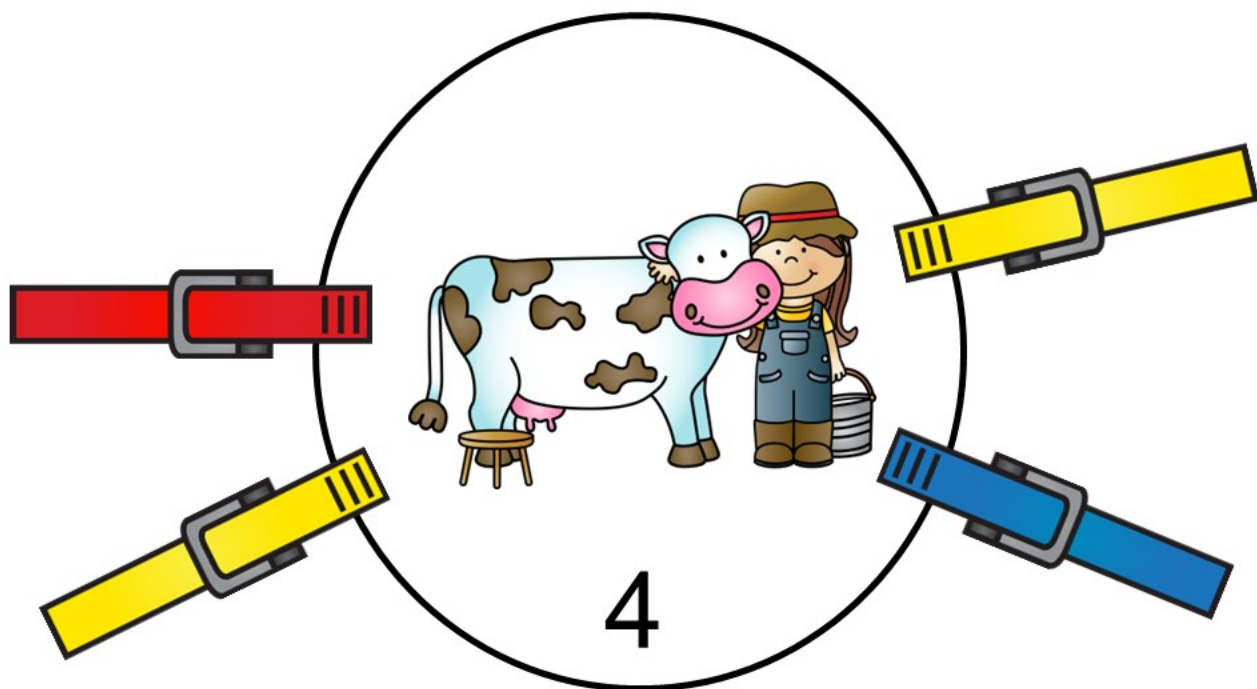

With counting dots on each card.

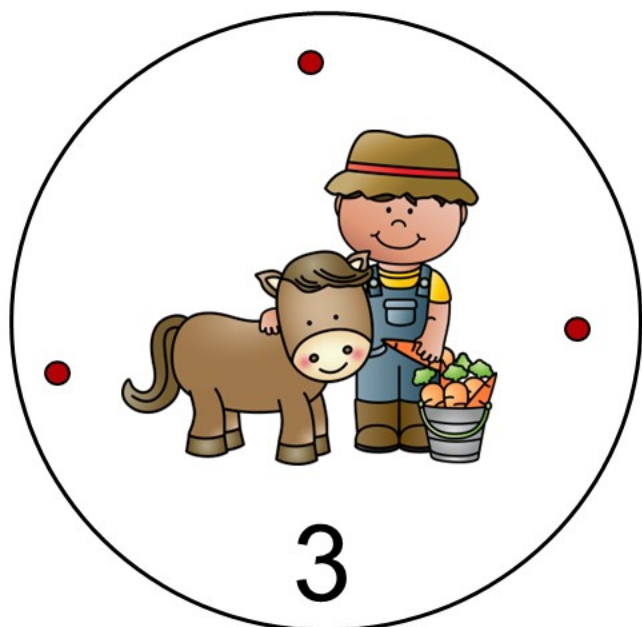
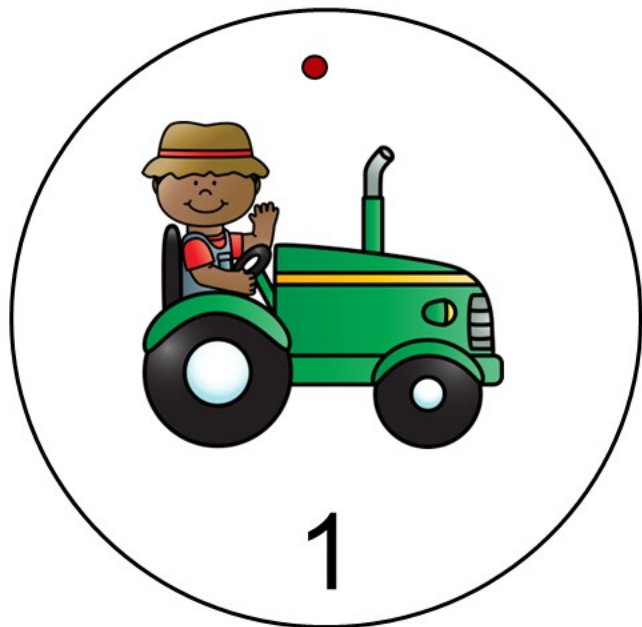

Print up on white cardstock,
Laminate and cut out.
Have children add the correct
number of clothes pins to
each farm card.

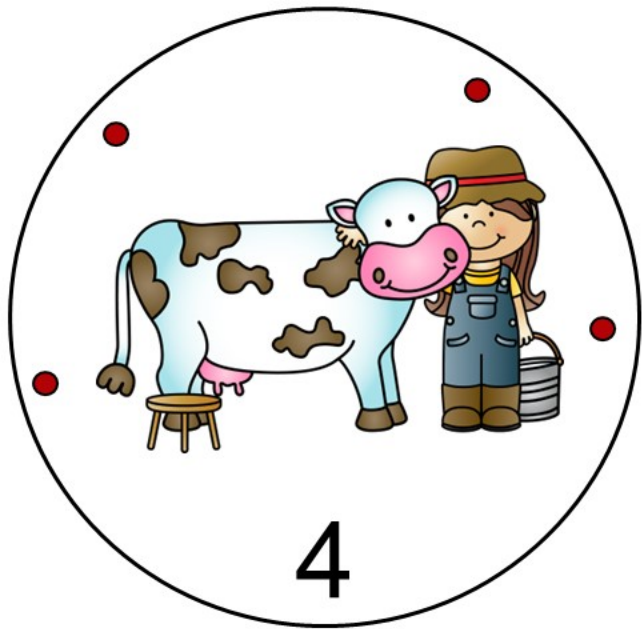

4

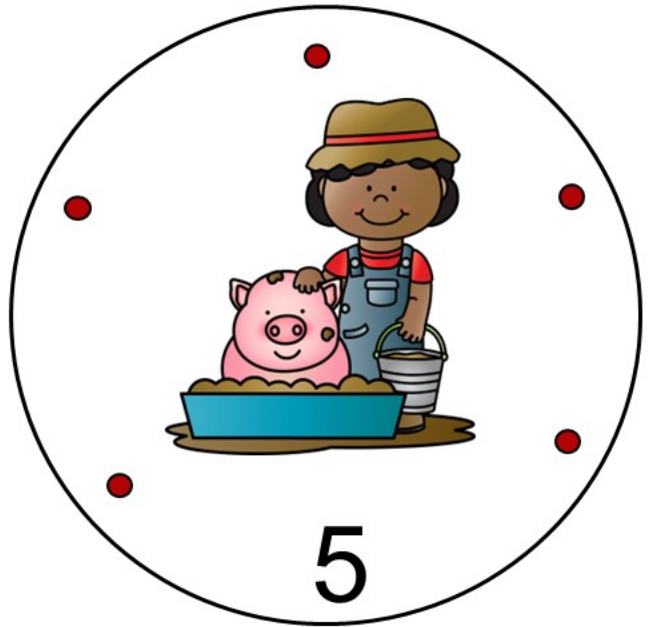

5

Without counting dots on each card.

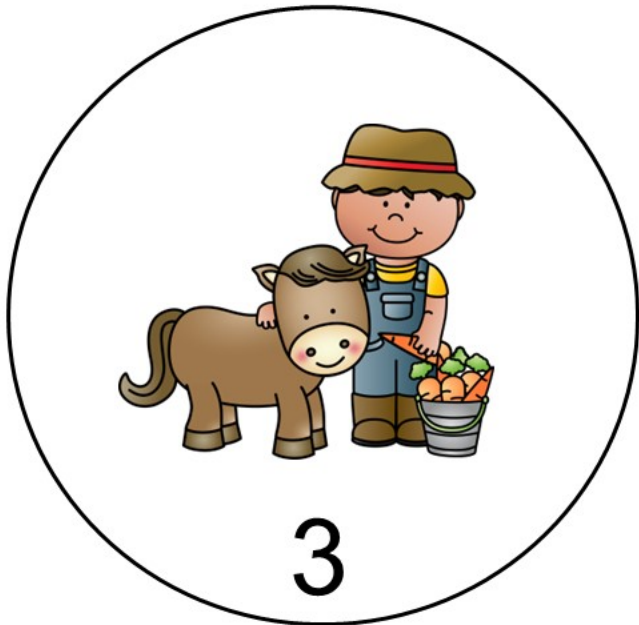
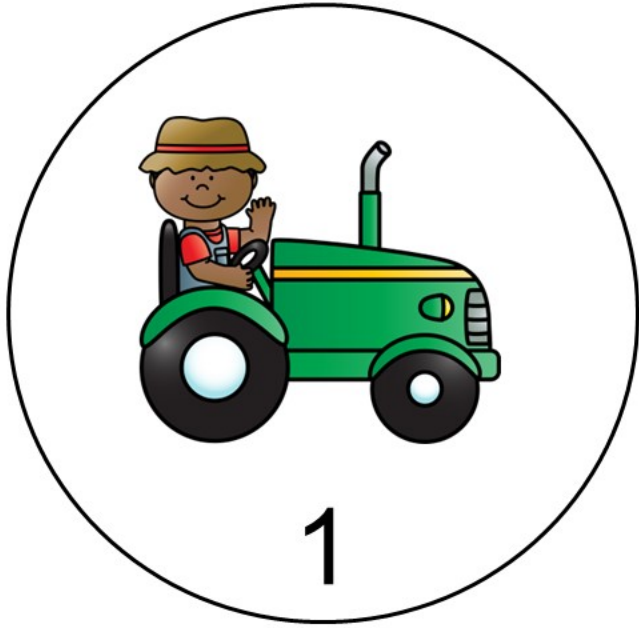

Print up on white cardstock,
Laminate and cut out.
Have children add the correct
number of clothes pins to
each farm card.

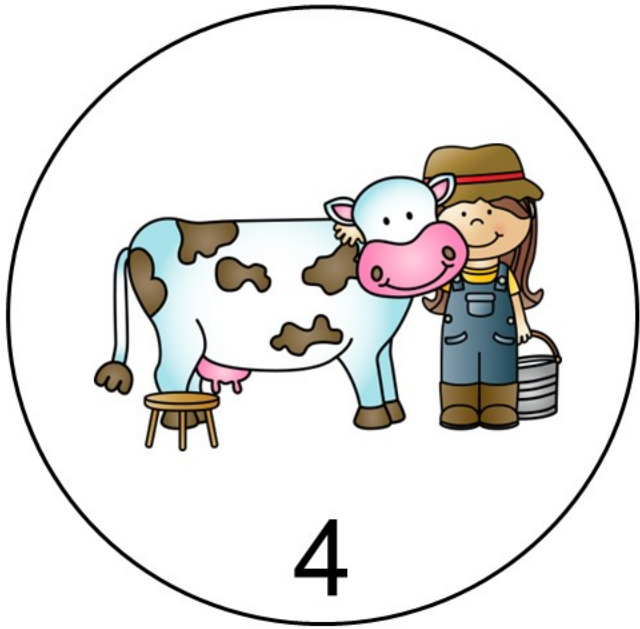

4

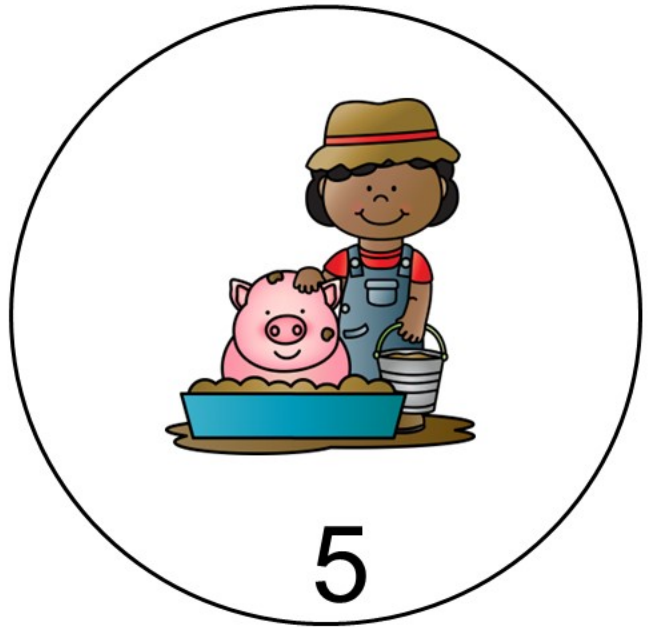

5

Tuesday

Farm Do A Dot Paint

Activity for 1 or more Toddlers

Duration of activity: 10 – 15 minutes

Domain: AL3-6: Approaches to Learning

Component: AL10-13: Processing and Utilizing Information

Subcomponent: A12 Cognitive Flexibility/Reasoning

Child considers more than one possible outcome

AL12.2 Notice's similarities and differences

Domain: Physical and Movement Development

Component: P5-6: Fine Motor

Subcomponent: P5 Dexterity Child can coordinate and control movement

of hands and fingers to grasp and manipulate objects.

P5.7 Begins to grasp crayon to scribble

Materials:

- Do A Dot Art Markers
- Farm Templates
- White card stock

Directions:

Print up the farm templates onto white card stock. Sit with toddlers at the table with their template and paint. Give the children the choice of colors. Have several for them to pick from. Ask them what color they would like to use and tell them what the name of the color they picked if they don't know.

As toddlers paint the farm picture, talk to them about the picture they are painting.



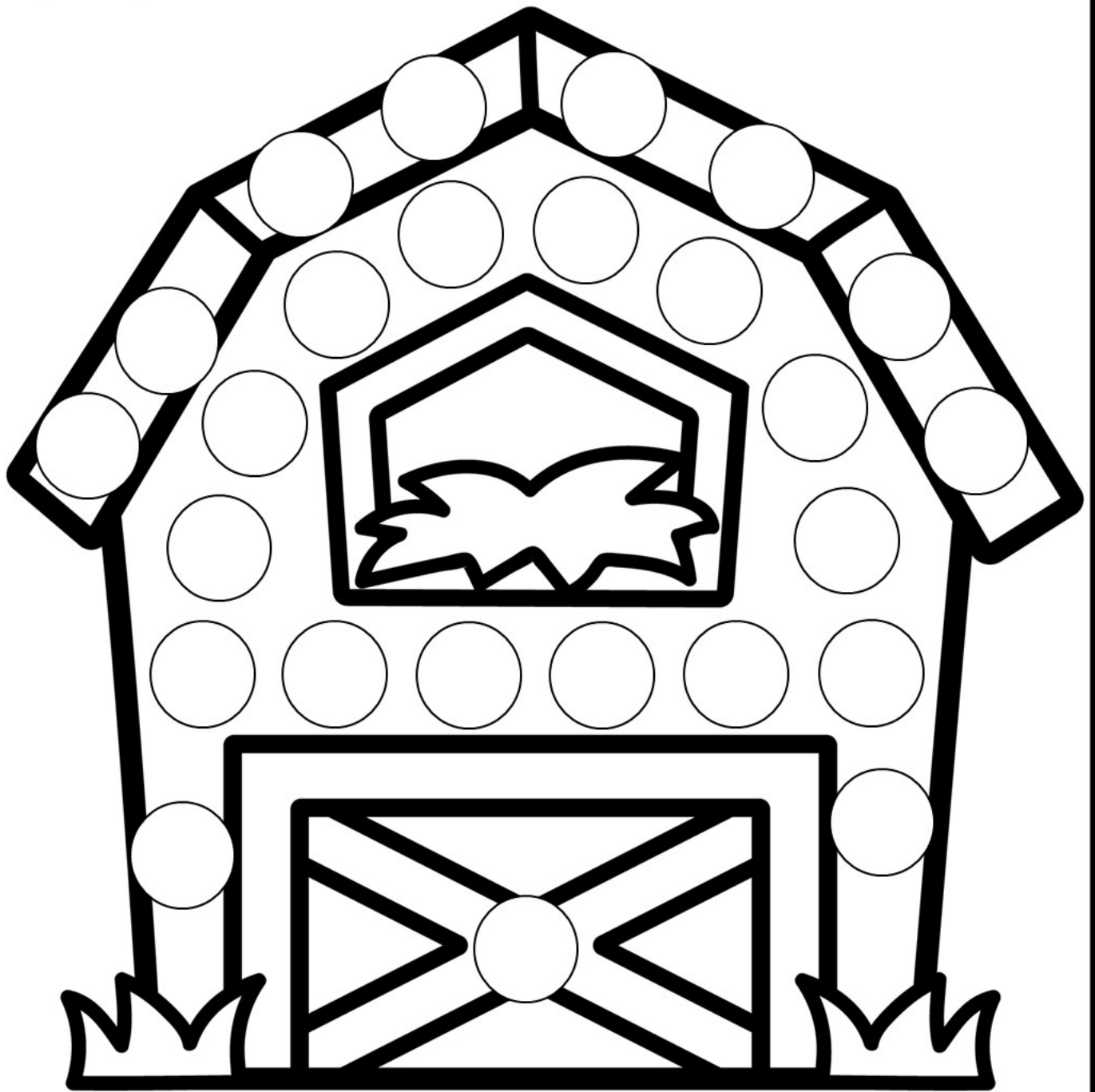

Barn

Silo

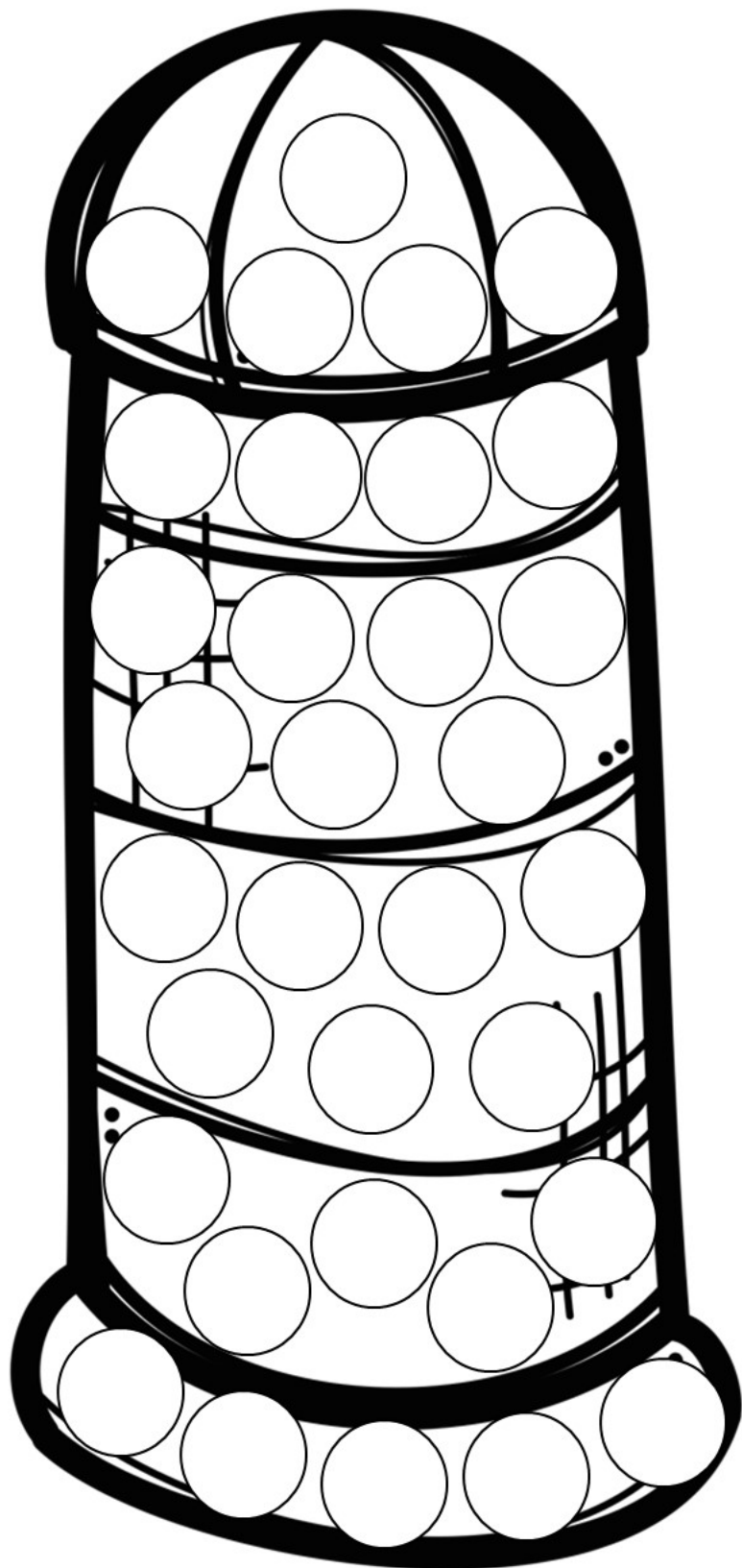

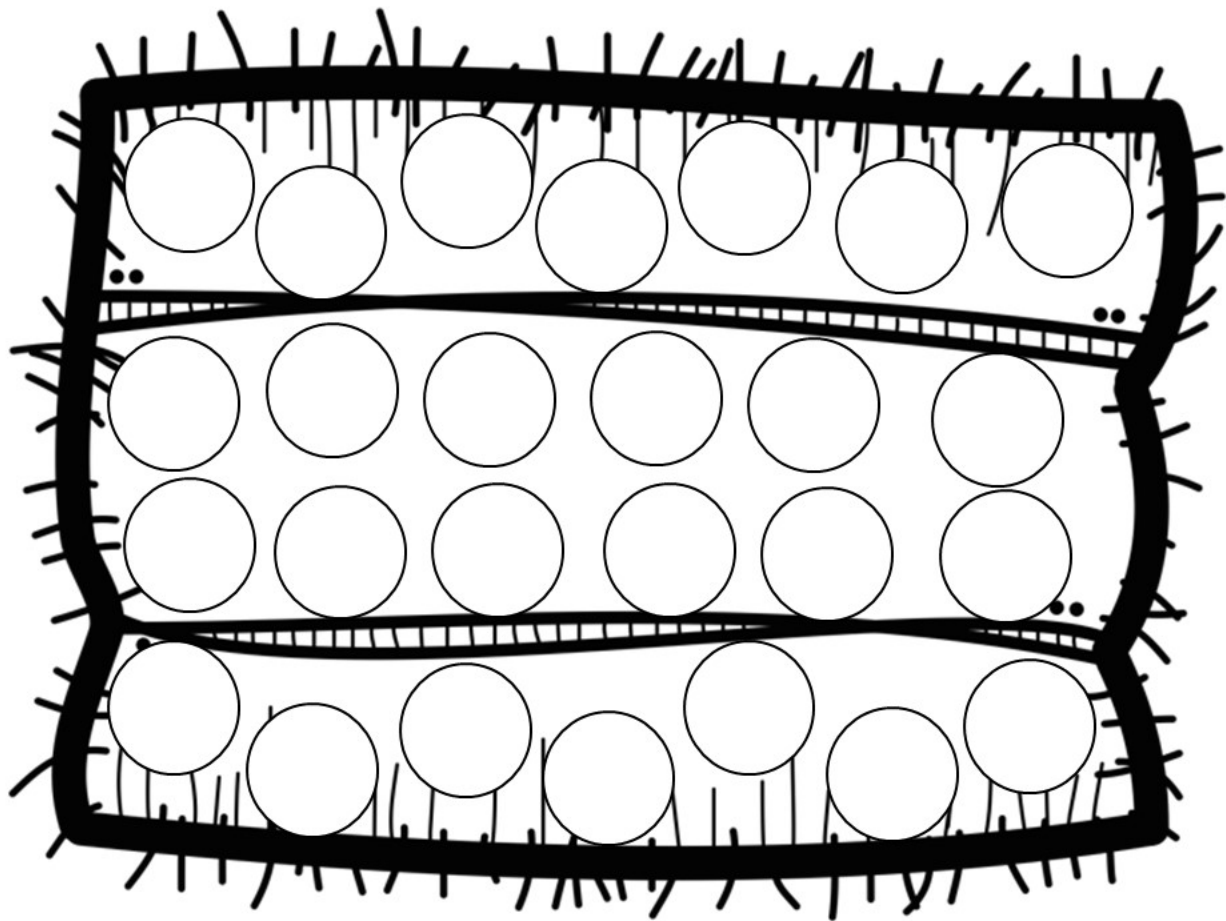

Bale of Hay

Farmer

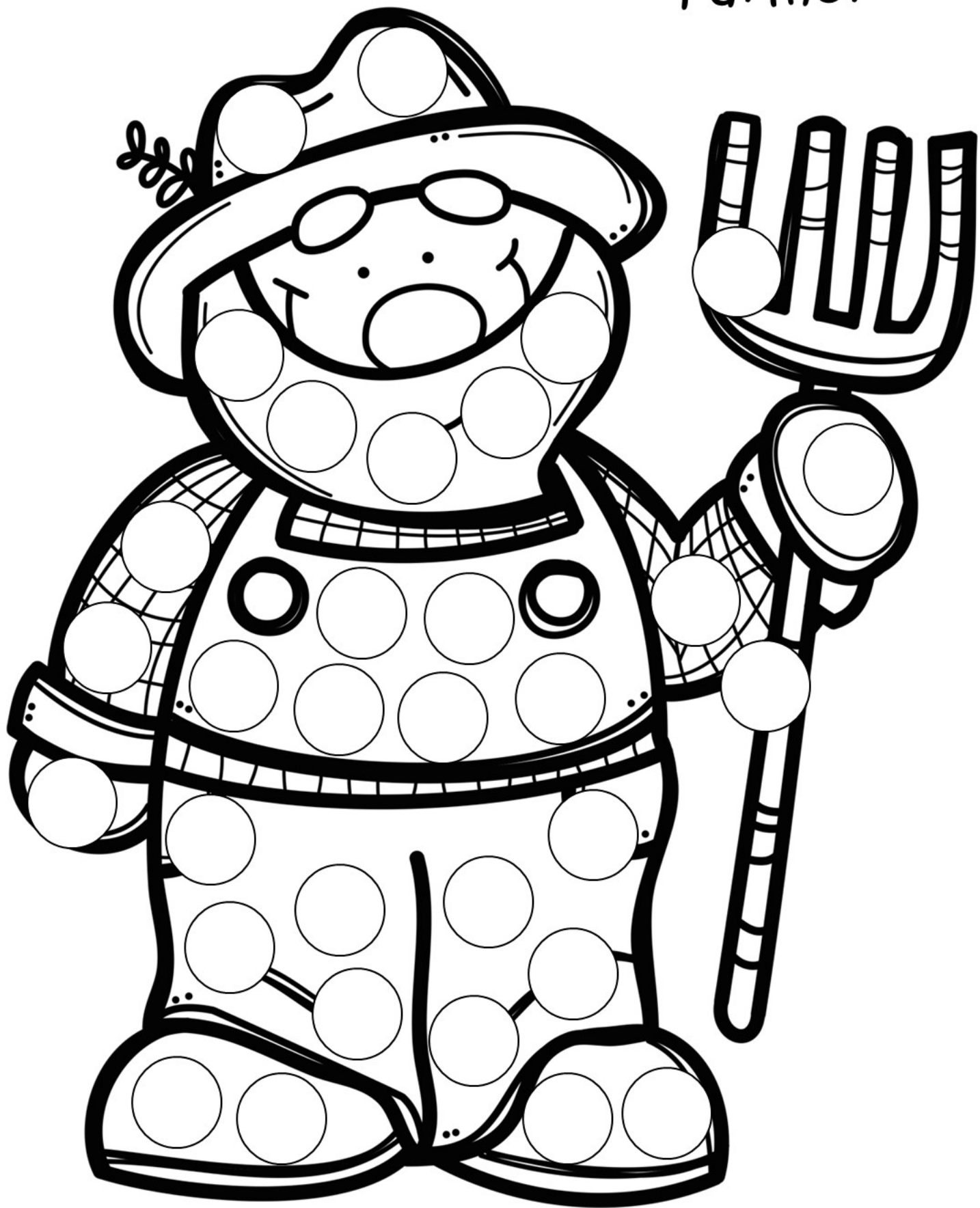

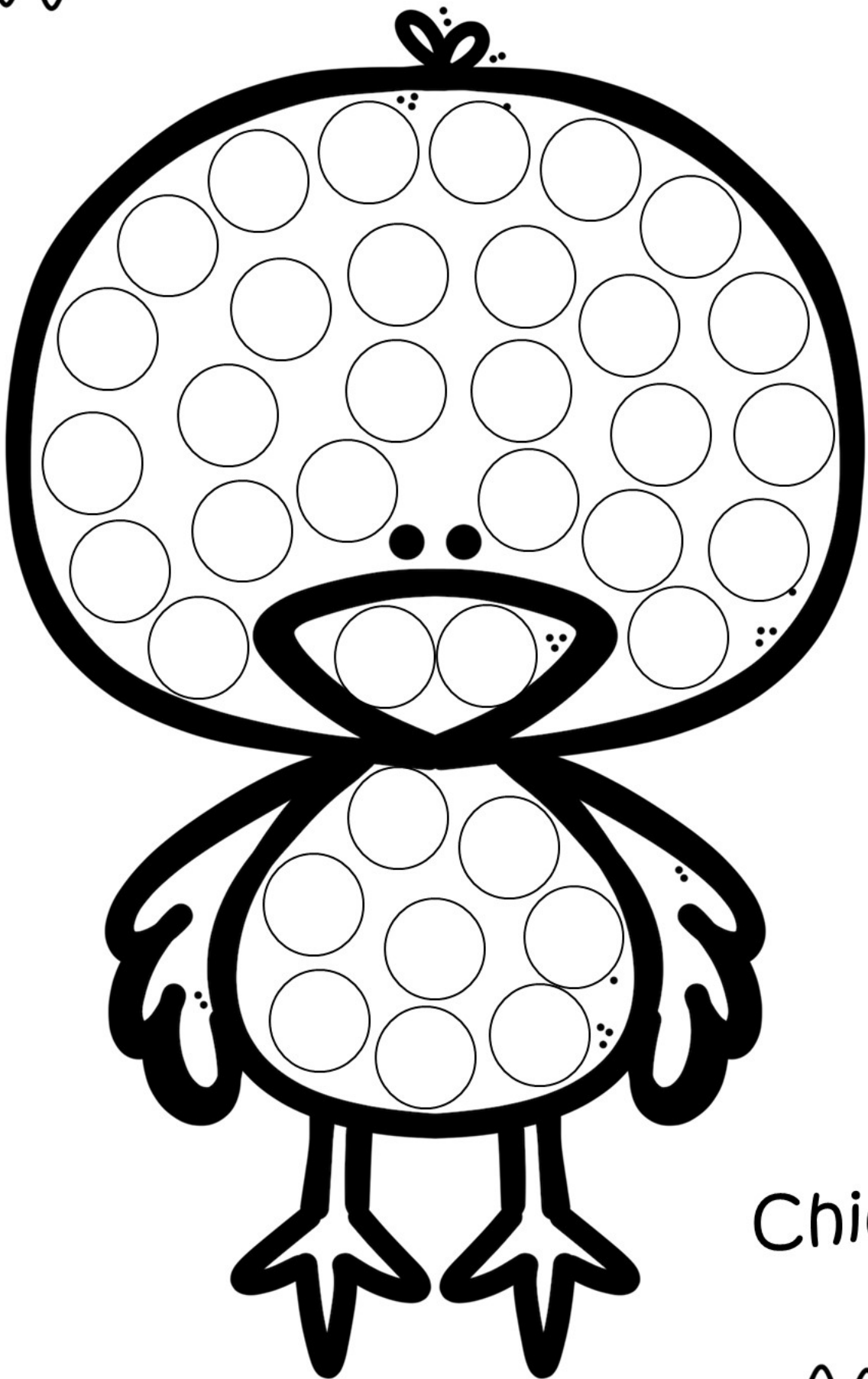

Chick

Teacher (s) _____ Week of: _____

Group: Toddlers

Theme: Down on the Farm

123 Learn Curriculum	Wednesday
Social Emotional	Activity: When talking with children, make eye contact. Look right into their eyes. When talking encourage them to coo or talk back.
	Component: Social Understanding and Relationships – S7 Building relationships
Approaches to Learning	Activity: Farm Shape Match Cards
	Component: AL1-2: Initiative and Curiosity
Language Literacy Communications	Activity: Reading Daily: Barnyard Dance – Plus other assorted theme related books.
	Component: Emergent Reading – L4 Motivation, engagement
The Arts	Activity: Singing or music playing daily
	Component: Exploring the Arts – A1
Social Systems Cognitive	Activity:
	Component:
Physical & Movement	Activity: Farm Movement Cards
	Component: P5-6: Fine Motor
Mathematics Cognitive	Activity:
	Component:
Scientific Thinking Cognitive	Activity:
	Component:

Wednesday

Farm Shape Match Cards

Activity for 1 or more Toddlers

Duration of activity: 10 - 15 minutes

Skill activity supports social and emotional development, cognitive development and fine motor

Domain: Approaches to Learning

Component: AL7-9: Creativity

Subcomponent: AL8 Playfulness

Child demonstrates a sense of humor and imagination in their play

AL8.3 Explores and uses materials in new and unconventional ways

Domain: Social and Emotional

Component: Social Understanding and Relationships

Subcomponent: S7 Building Relationships:

Child establishes and sustains relationships with others

S7.1 Shows a preference for a trusted adult

S7.2 Notices or responds to others

Domain: Physical and Movement Development

Component: P5-6: Fine Motor

Subcomponent P5 Dexterity:

Child can coordinate and control movement of hands and fingers to grasp and manipulate objects.

P5.1 Reaches for toy, grasp it and releases

Materials:

- Shape Cards
- Clothes Pins
- Laminating sheets

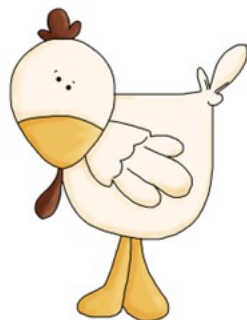

Directions: Print up cards onto white card stock. Trim and laminate.

Wednesday

Have children sit at the table with the shape cards and clothes pins. Show the toddler the shape on the card at the top, ask them if they know the shape and if not tell them the shape and ask them to show you the shape on the bottom of card. If they can, have them place a clothes pin on the shape.

Good small motor skills. Let them practice opening and closing the clothes pin.

Fun and cute clothespins..... Talk to them about the color clothespin they are using. Ask them to pick the blue clothespin to use.

To purchase from Amazon.com, click on picture below



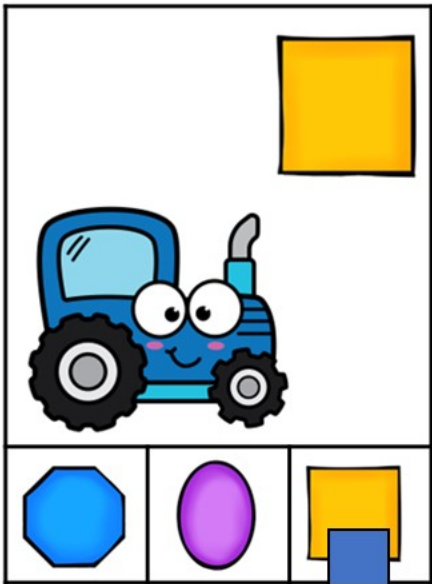
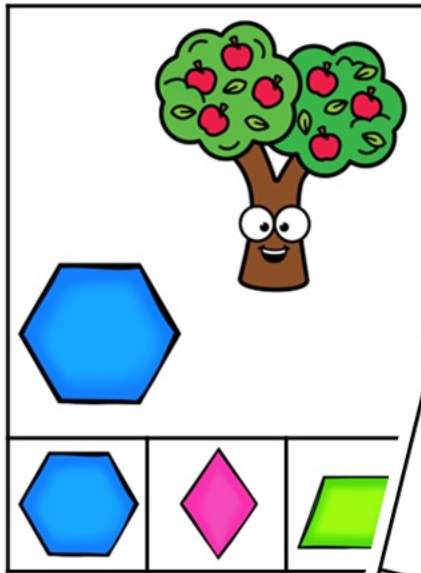
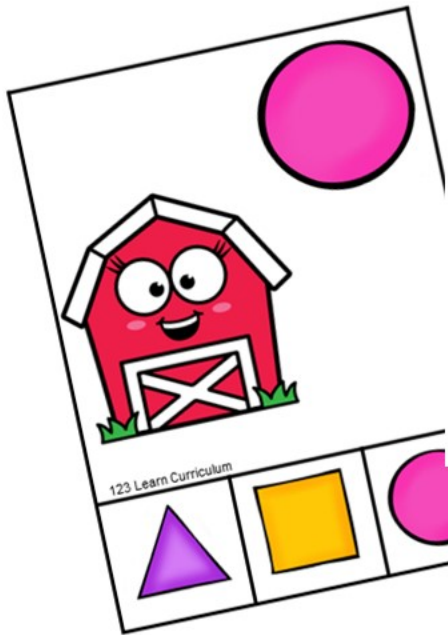

Use clothes pins to match the shape on each card. Talk about the color of the matching shape,

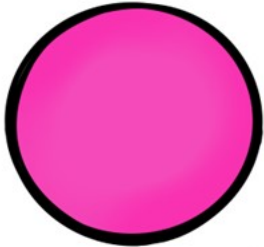

123 Learn Curriculum

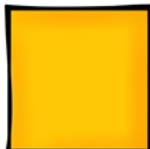
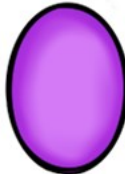
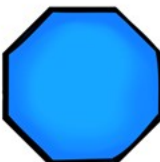
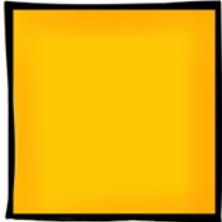
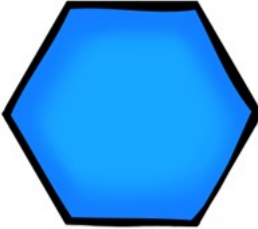
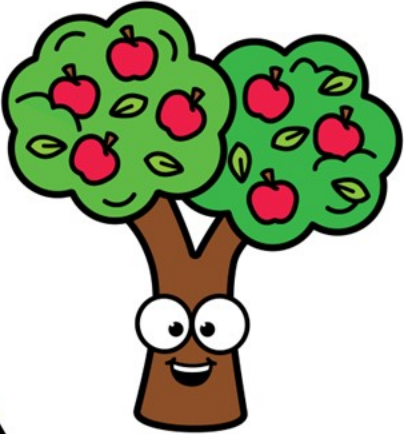
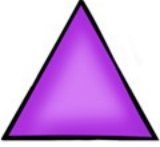

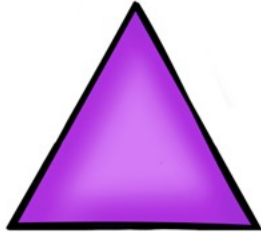

123 Learn Curriculum

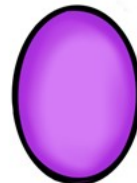
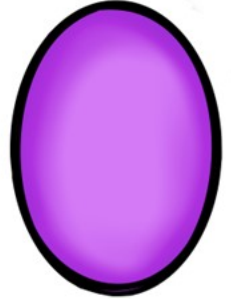
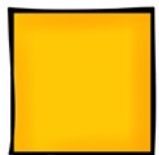
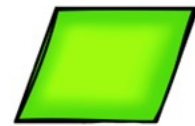
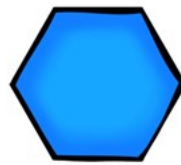
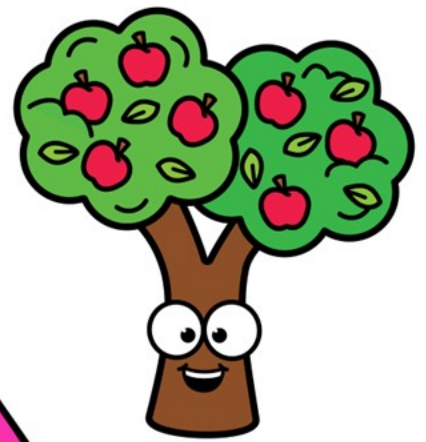
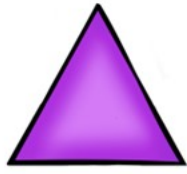

Wednesday

Reading Books

Activity for 1 or more toddlers

Duration of activity: 5 – 10 minutes

Skill activity support: social, emotional development and language

Domain: Social and Emotional

Component: Social Understanding and Relationships

Subcomponent: S7 Building Relationships

Child establishes and sustains relationships with others

S7.3 Shows preferences for one or more adults or children

S7.4 Shows some awareness or caution with unfamiliar adults

S7.5 Uses trusted adult(s) as a base from which to explore

Domain: Language Literacy Communications

Component: L4-8: Emergent Reading

Subcomponent: L4 Motivation, engagement Child has an interest in and sustained attention for literacy acts

L4.2 Makes sounds while looking at text or images

L4.3 Points to a few pictures in books and in response to adult questions

L4.4 Demonstrates interest and involvement with books and printed materials

Materials needed:

- Themed books

Spend time reading to the toddler/s books that are theme related. You can check the farm list included with this lesson plan.



Wednesday

Farm Movement Cards

Activity for 1 or toddlers

Duration of activity: 10 - 15 minutes

Skill activity supports cognitive – large motor skills

Domain: Physical and Movement Development

Component: P1-4: Gross Motor

Subcomponent P3 Locomotion: Childs moves their body through space from one place to another

P3.7 Runs Freely

Domain: Approaches to Learning

Component: AL3-6: Attentiveness, Engagement and Persistence

Subcomponent: AL3 Attending

Child focuses visual and auditory attention on relevant aspects of the environment

AL3.2 Stays focused on activities for a short period of time

Domain: Social and Emotional Development

Component: S4-5: Self-Management

Subcomponent: S4 Managing thinking

Child manages attention and thoughts

S4.5 Anticipates and follows simple routines



Wednesday

Farm Movement Cards

Activity for 1 or toddlers

Duration of activity: 10 - 15 minutes

Materials:

- White card stock
- Laminating sheets
- Scissors

Directions: Print up farm movement cards. Laminate and trim.

Have children gather around. Have one of the children pick a card. Read it, and everyone does what's on the card.

Let every toddler take turns picking a card and everyone doing the activities. Do activity until children want to move on to another activity.



Down on the Farm Movement Cards

I can GALLOP



like a
horse

I can WADDLE



like a
duck

I can Chomp



like a
cow

I can ROLL in the
mud



like a
pig

I can STRUT

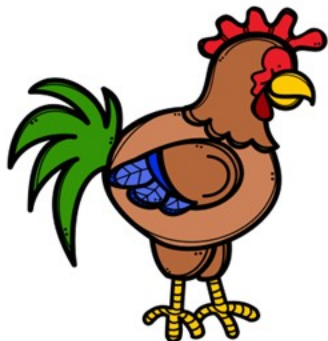

like a
rooster

I can
STRETCH

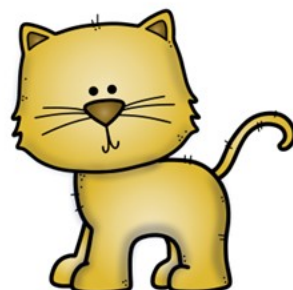

like a
cat

Down on the Farm Movement Cards

I can GRAZE

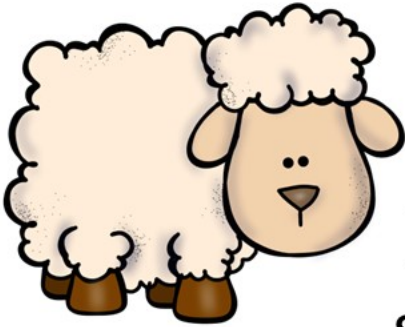

like a
sheep

I can FLAP



like a
chicken

I can SCURRY

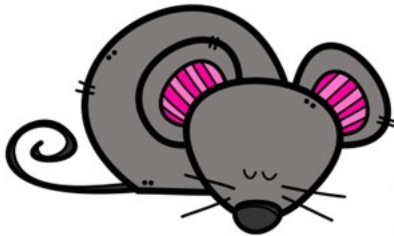

like a
mouse

I can KICK



like a
donkey

I can HOP

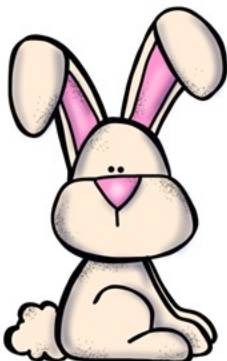

like a
bunny

I can
SWAY



like a
scarecrow

Teacher (s) _____ Week of: _____

Group: Toddlers

Theme: Down on the Farm

123 Learn Curriculum	Thursday
Social Emotional	Activity: Be a positive role model: Offer children opportunities to observe you being a kind and caring person.
	Component: Social Understanding and Relationships – S7 Building relationships
Approaches to Learning	Activity: Shape and Color Match
	Component: M1.6: Number Knowledge
Language Literacy Communications	Activity: Reading Daily: Barnyard Dance – Plus other assorted theme related books.
	Component: Emergent Reading – L4 Motivation, engagement
The Arts	Activity: Singing or music playing daily
	Component: Exploring the Arts – A1
Social Systems Cognitive	Activity:
	Component:
Physical & Movement	Activity: Pipe Cleaning Sculptures
	Component: P5-6: Fine Motor
Mathematics Cognitive	Activity:
	Component:
Scientific Thinking Cognitive	Activity:
	Component:

Thursday

Shape and Color Match

Activity for 1 or more toddler

Duration of activity: 15 – 20 minutes

Skill activity support: cognitive development / small motor

Domain: Mathematics - Cognitive

Component: M1-6: Number Knowledge

Subcomponent: M1 Rote counting:

The child attends to sequences and use of number words, with or without items, sets, or numerals and without recognizing the link to quality

M1.4 Imitates counting

Domain: Social and Emotional Development

Component: S6-8: Social Understanding and Relationships

Subcomponent: S7 Building Relationships

Child establishes and sustains relationships with others

S7.1 Shows a preference for a trusted adult

S7.2 Notices or responds to others

Materials:

- White card stock
- Laminating sheets
- Shape Buttons
- Small bowl



Thursday

Shape and Color Match

Activity for 1 or more toddlers

Duration of activity: 10 – 15 minutes

Directions:

Print up shape and color sheets onto white card stock.
Laminate.

Have available buttons to match the cards.

With toddler's, sit at the table. Have shape and color cards close at hand. Have toddler pick a card and put in front of them. Ask them if they know what color the button is on the card, and what shape it is. Tell them the color and shape and ask them if they can find the matching color / shape to place on top of each card.



To purchase from Amazon, please click on picture.

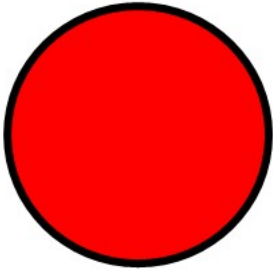
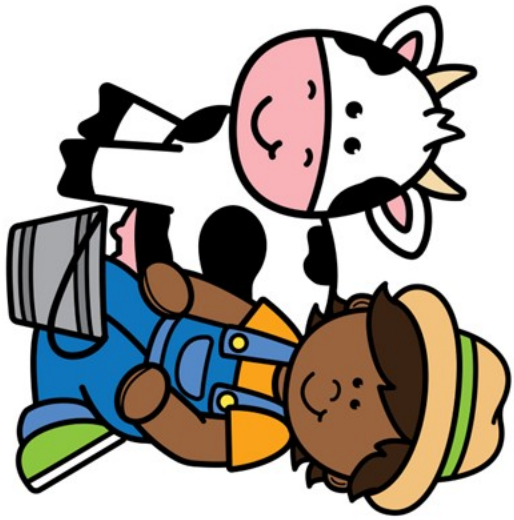

Red



Blue

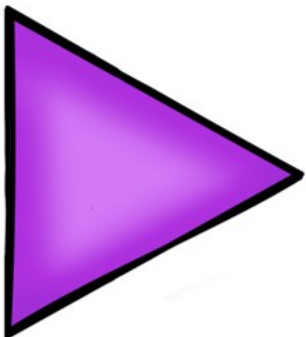

Purple

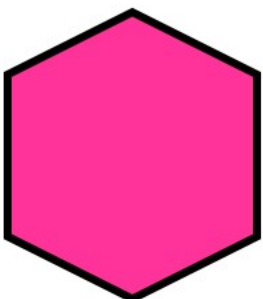

Pink

Orange

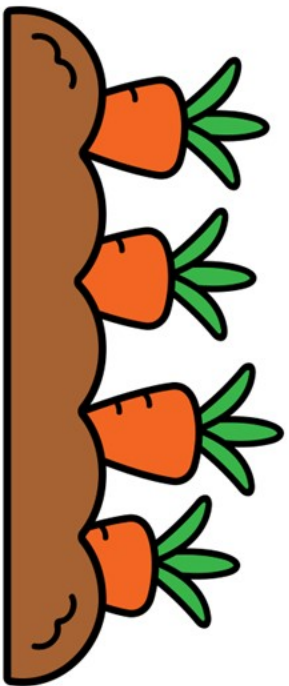
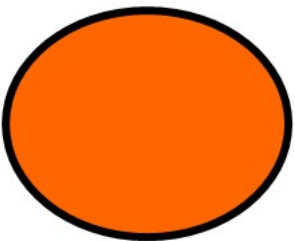

White

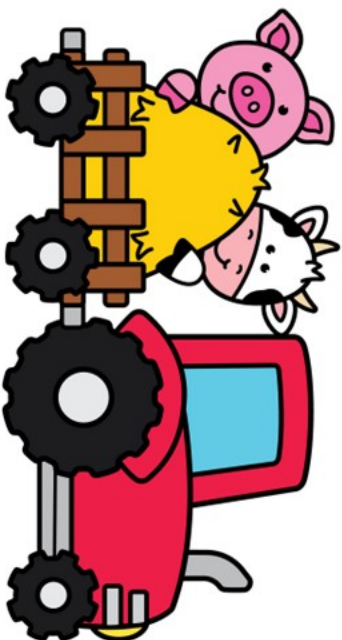
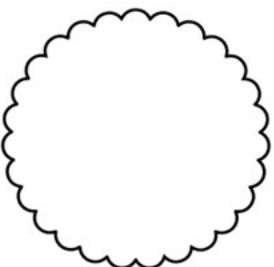

Green

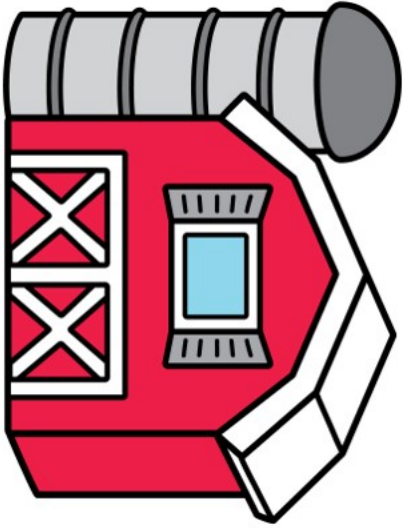
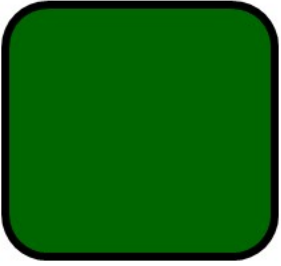

Yellow

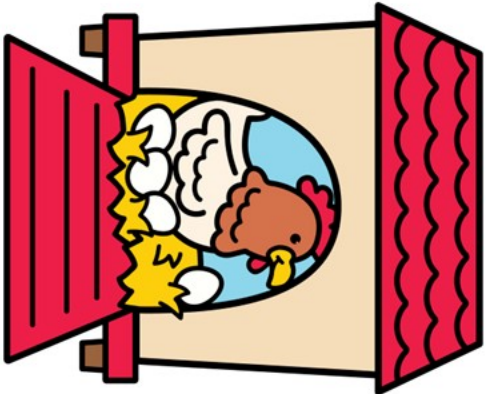
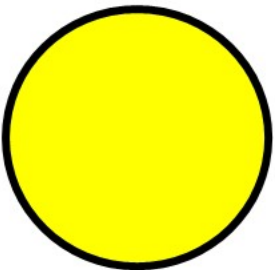

Thursday

Pipe Cleaning Sculptures

Activity for 1 or more toddler

Duration of activity: 10 – 15 minutes

Simple activity that is so much fun for toddlers and a great way to incorporate colors. Skill activity supports social and emotional development, language, cognitive and fine motor.

Domain: Approaches to Learning

Component: AL&-9: Creativity

Subcomponent: AL8: Playfulness

Child demonstrates a sense of humor and imagination in their play

AL8.3 Explores and uses materials in new and unconventional ways

Domain: Social and Emotional

Component: Social Understanding and Relationships

Subcomponent: S7 Building Relationships:

Child establishes and sustains relationships with others

S7.1 Shows a preference for a trusted adult

S7.2 Notices or responds to others

Domain: Physical and Movement Development

Component: P5-6: Fine Motor

Subcomponent P5 Dexterity:

Child can coordinate and control movement of hands and fingers to grasp and manipulate objects.

P5.1 Reaches for toy, grasp it and releases

Materials needed:

- Plastic colander (1 per toddler)
- Assorted pipe cleaners

Sit down toddlers at a table with a plastic colander. (Turn the colander upside down on the table). Give them different colored pipe cleaners and show them how they can take the “blue” one, stick it in one of the holes, bend the other end and stick it into another hole on the colander. Tell them to take more and let’s see what kind of sculpture they can create.

A fun time to bring up the different colors of each pipe cleaner they are going to use

Pipe Cleaning Sculptures



Sample pictures of pipe cleaning sculptures.

Toddlers and preschoolers all enjoyed this activity.

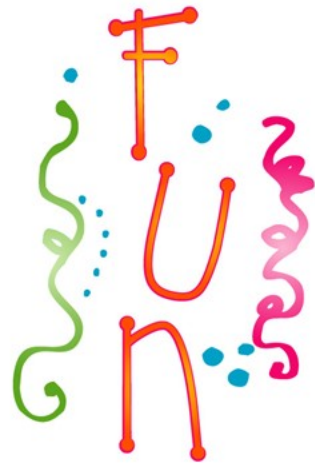

Check your local dollar store to purchase colanders. So, you can have several children doing this activity at one time.



Teacher (s) _____ Week of: _____

Group: Toddlers

Theme: Down on the Farm

123 Learn Curriculum	Friday
Social Emotional	Activity: Be a positive role model: Offer children opportunities to observe you being a kind and caring person.
	Component: Social Understanding and Relationships – S7 Building relationships
Approaches to Learning	Activity: Farm Match
	Component: Initiative and Curiosity – AL1
Language Literacy Communications	Activity: Reading Daily: Barnyard Dance – Plus other assorted theme related books.
	Component: Emergent Reading – L4 Motivation, engagement
The Arts	Activity: Singing or music playing daily
	Component: Exploring the Arts – A1
Social Systems Cognitive	Activity:
	Component:
Physical & Movement	Activity: Farm Playdough Mats
	Component: P5-6: Fine Motor
Mathematics Cognitive	Activity:
	Component:
Scientific Thinking Cognitive	Activity:
	Component:

Friday

Farm Match

Activity for 1-2 Toddlers

Duration of activity: 10 – 15 minutes

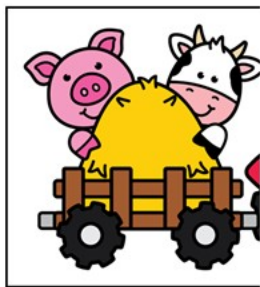

Supplies:

- White card stock
- Laminating sheets
- Scissors

Directions:

- Print up farm templates on white card stock.
- Laminate and trim.
- Cut each card in $\frac{1}{2}$ on the dotted line.

Have children sit at the table with the cut-out farm pictures. Have them take the top part of a picture and ask them to find the matching half. Point to them the colors on the top part of the farm picture and ask them if can we find the lower part with the same colors.

Once child finds the match put together and do another farm match.

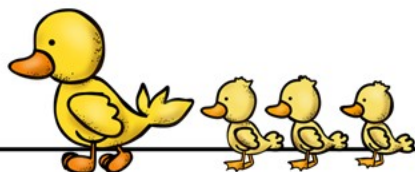

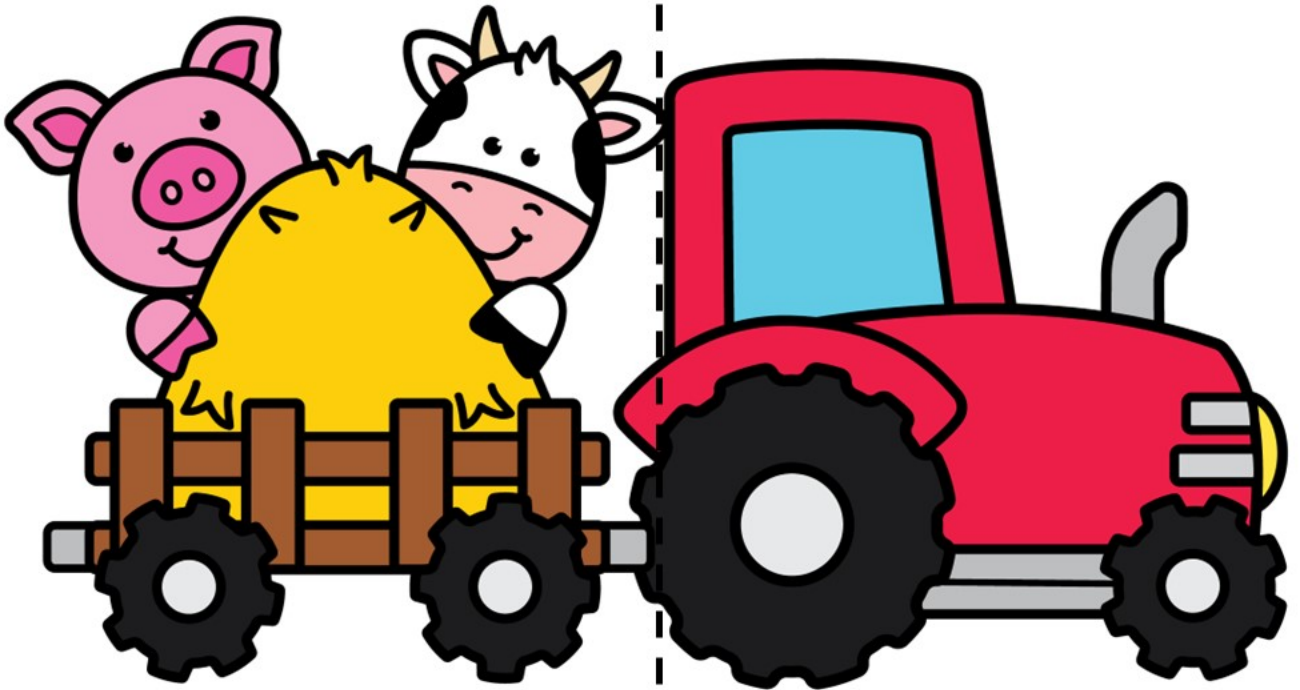
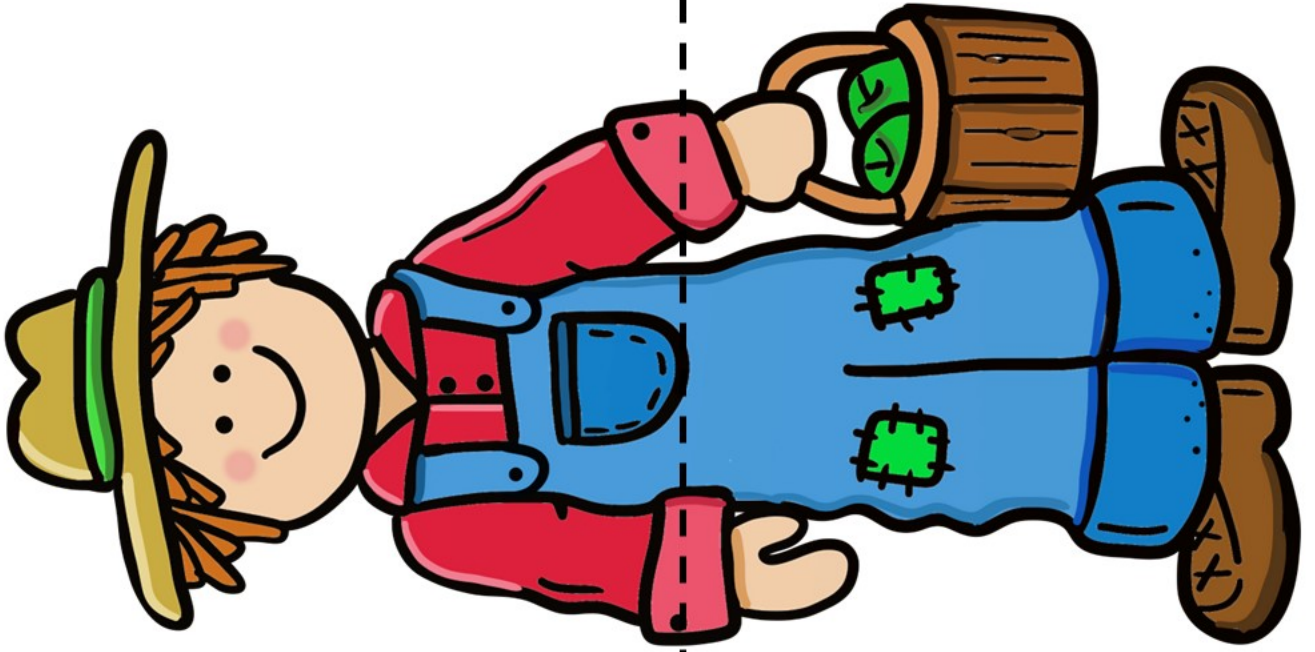

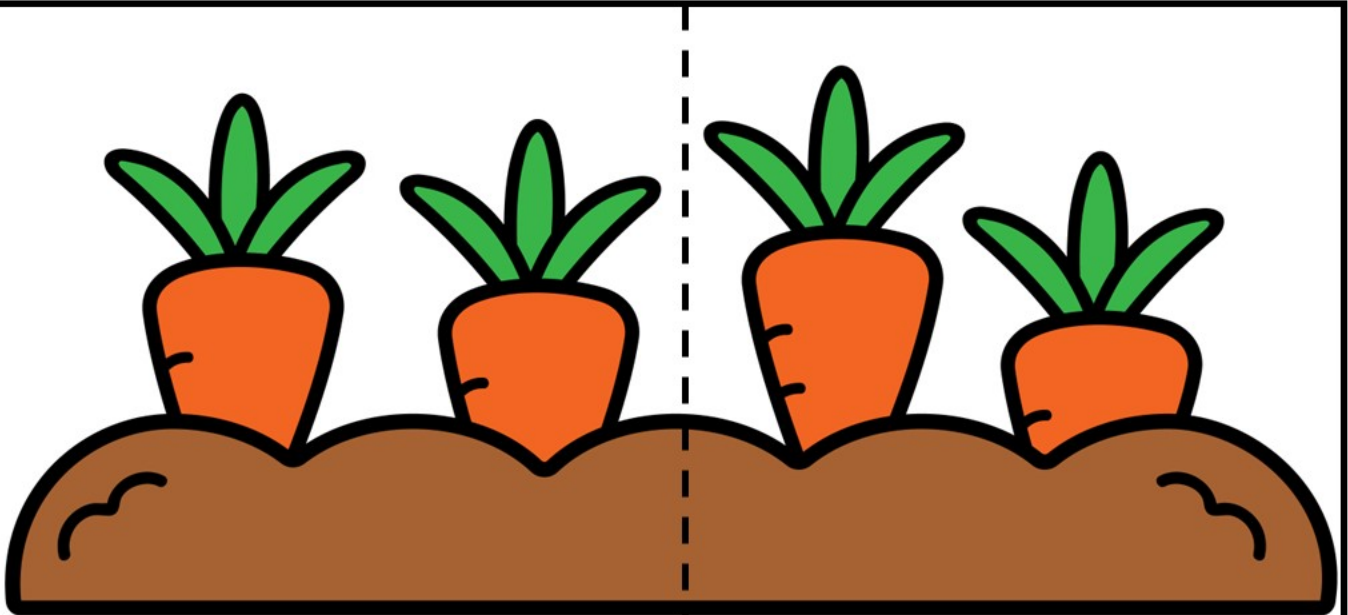
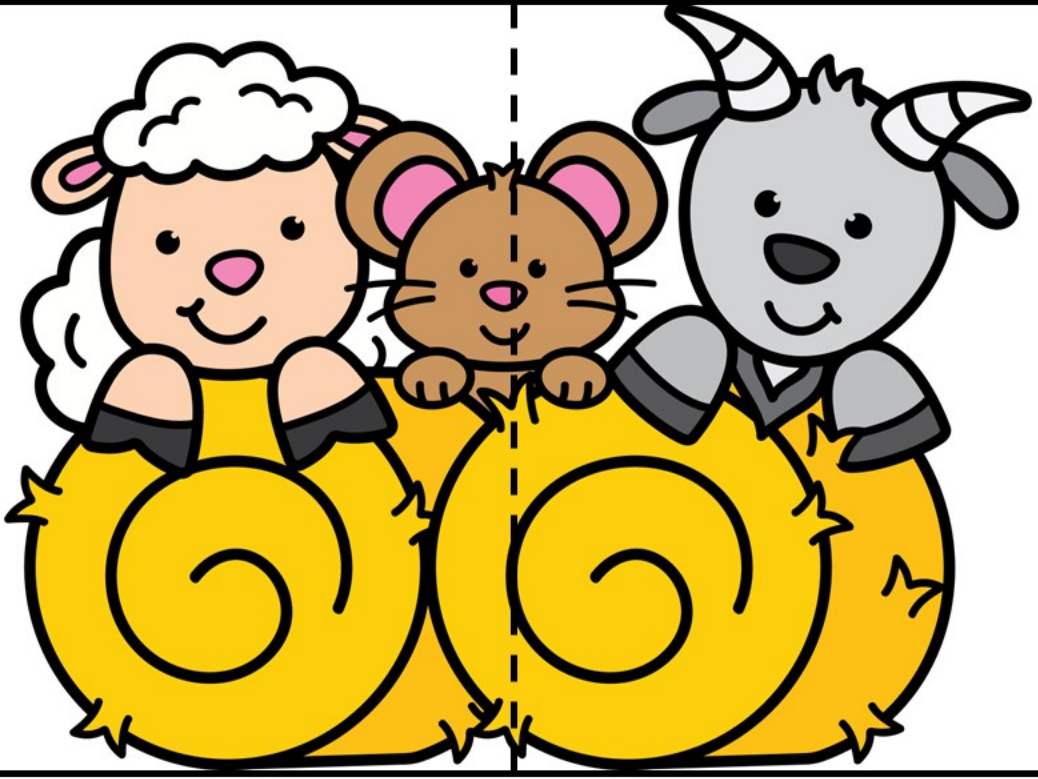

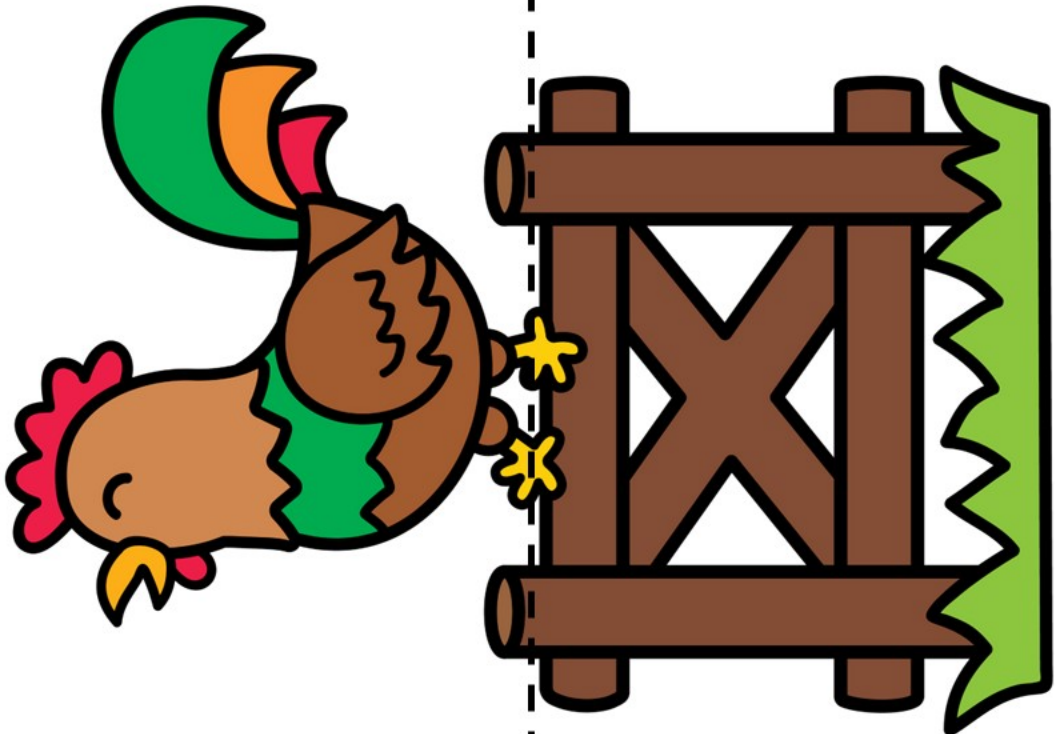

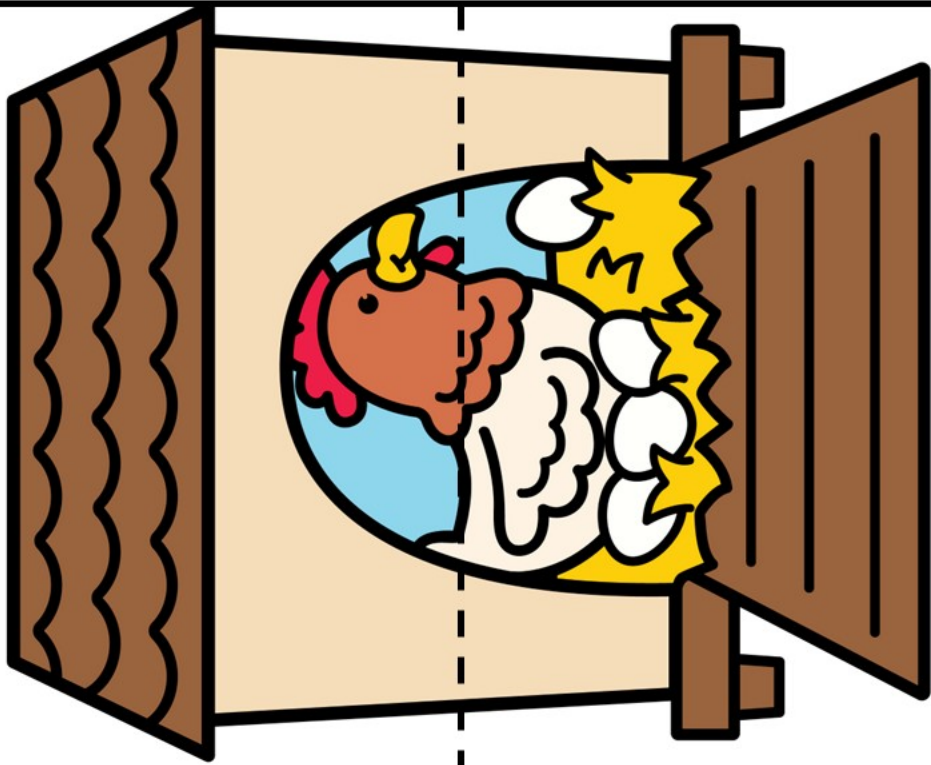

Friday

Farm Playdough Mats

Activity for 1 or more toddlers

Duration of activity: 10 - 15 minutes

Skill activity supports social and emotional development and small motor

Domain: Physical and Movement Development

Component: P5-6: Fine Motor

Subcomponent P5 Dexterity:

Child can coordinate and control movement of hands and fingers to grasp and manipulate objects.

P5.1 Reaches for toy, grasp it and releases

Materials:

- White cardstock
- Laminating sheets
- Assorted colors of playdough

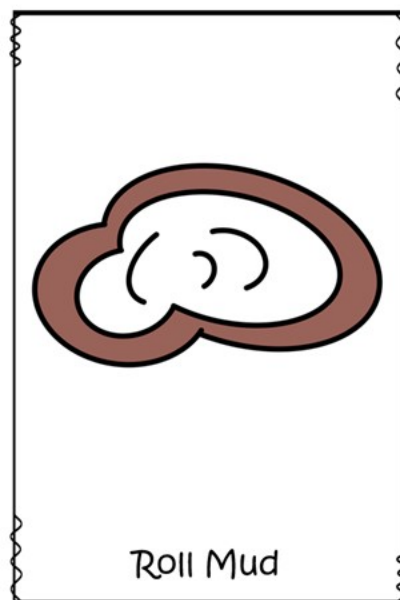
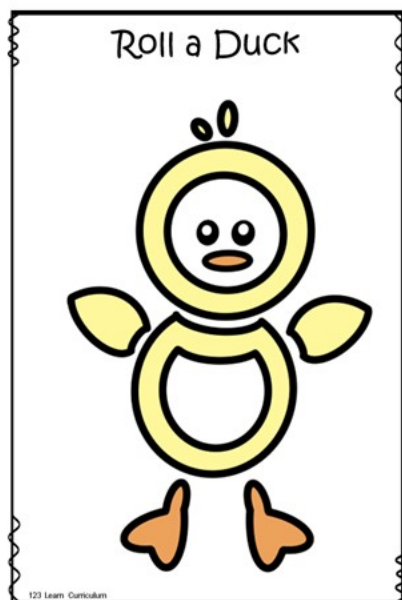

Playdoh Mats Practice

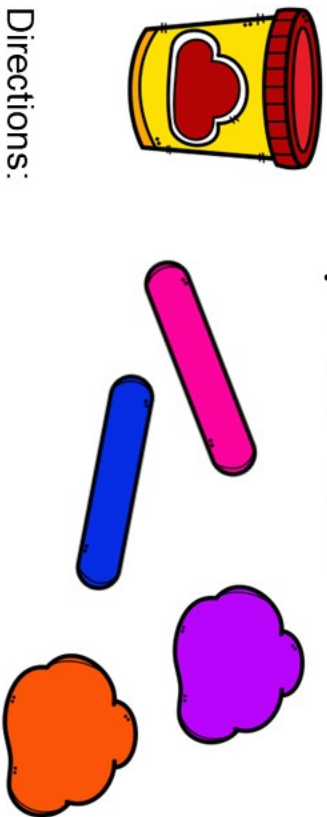

Directions:
Print up, laminate and trim.

Sit at the table with children and playdough mats. Talk to them about the mat they pick to use and read the card. Let them know what they need to do for each playdough mat. Show children how to roll the playdough to make pieces for each card.

Children can also take the playdough and press onto the pictures to fill in the space. Kids will have fun working their fingers squishing and pulling the playdough.

Toddlers will have fun squishing the playdough. They will have more fun playing then creating, but playdough mats are a fun fine motors activity. You can also use these mats for preschool.

Roll a Chick

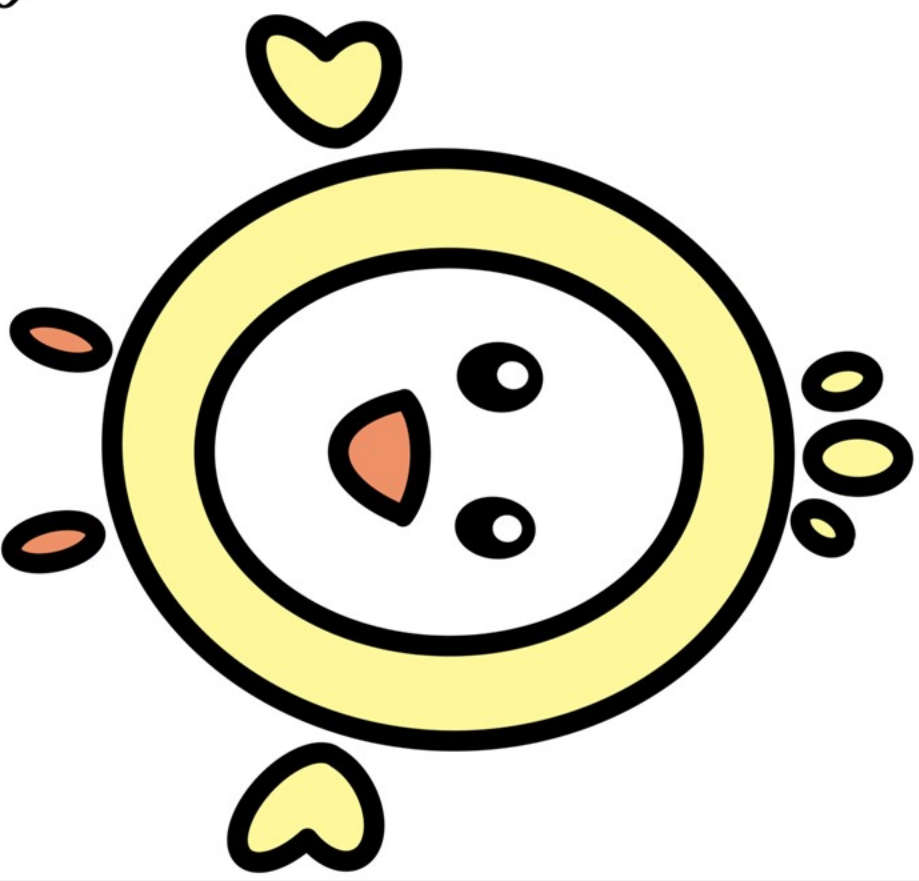

Roll a Duck

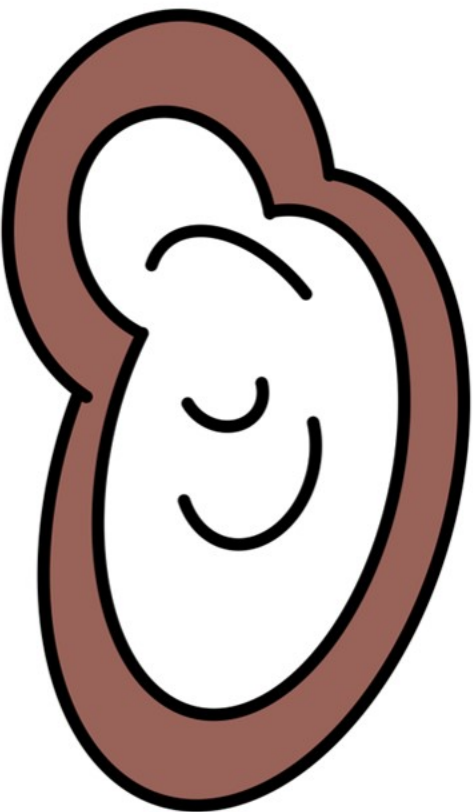
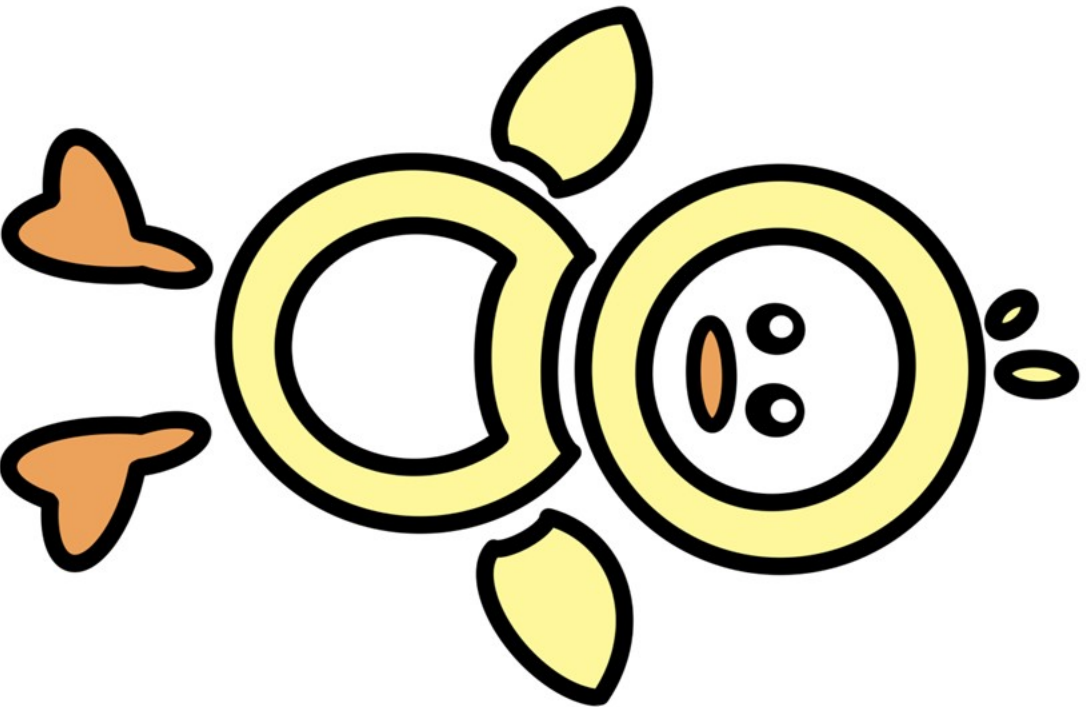

Roll Mud

Roll a Bale of hay

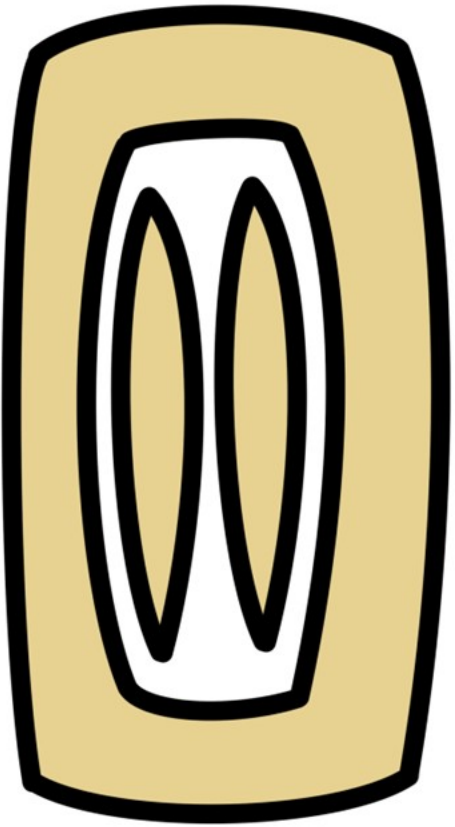

Roll a Cat

Roll a Rooster

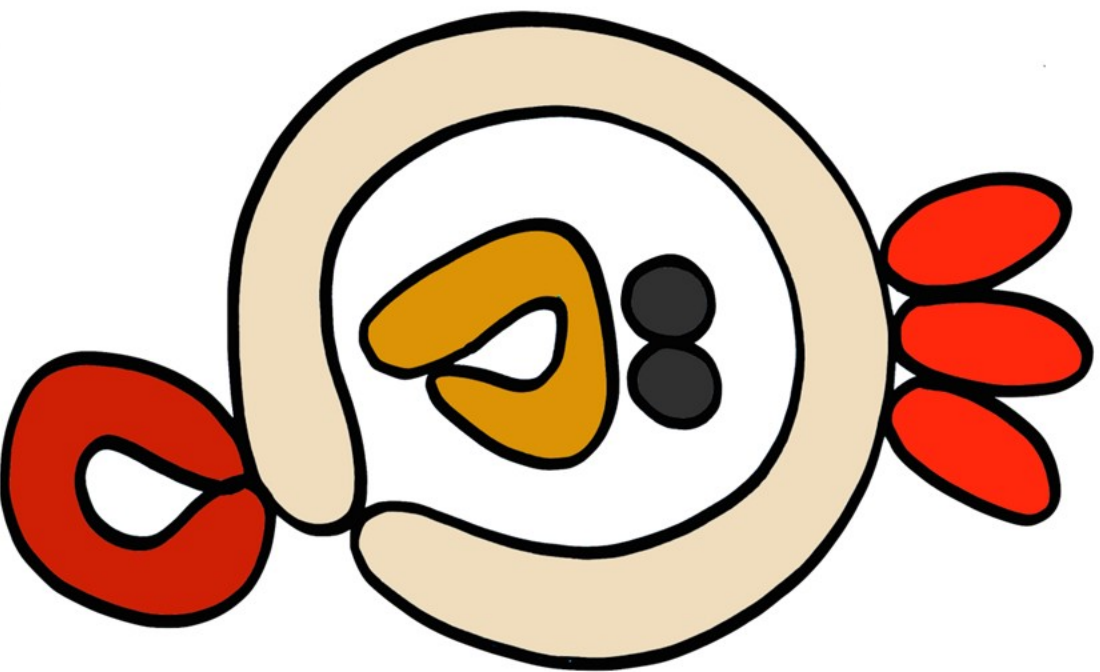

Roll a Sheep

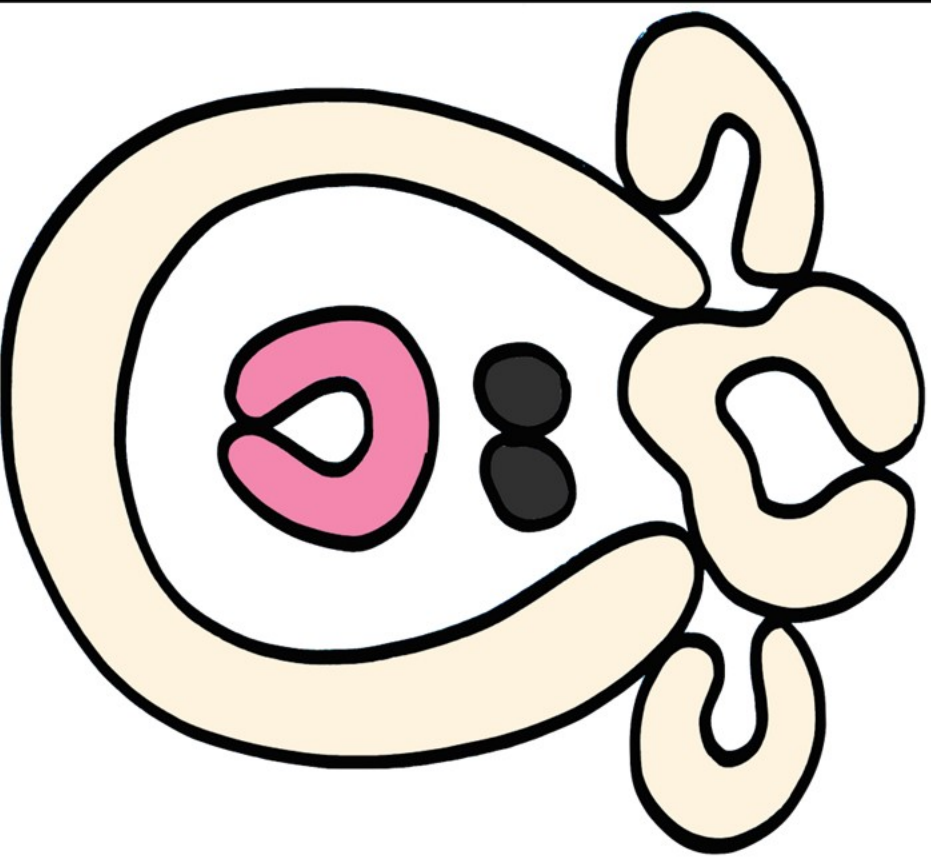

Organizing Your Toddler Activities

Planning how you will organize your toddler activities can be as easy and simple as you want it to be. Do you want it to be easier to access? The following pages and pictures will show you a way to organize and have it easily accessible to you when you do your Down on the Farm theme.

There will be pictures and links to purchase folder and pocket folders. Take these ideas and shop your local Target, or other stores to find items that will work in your organization of your theme.

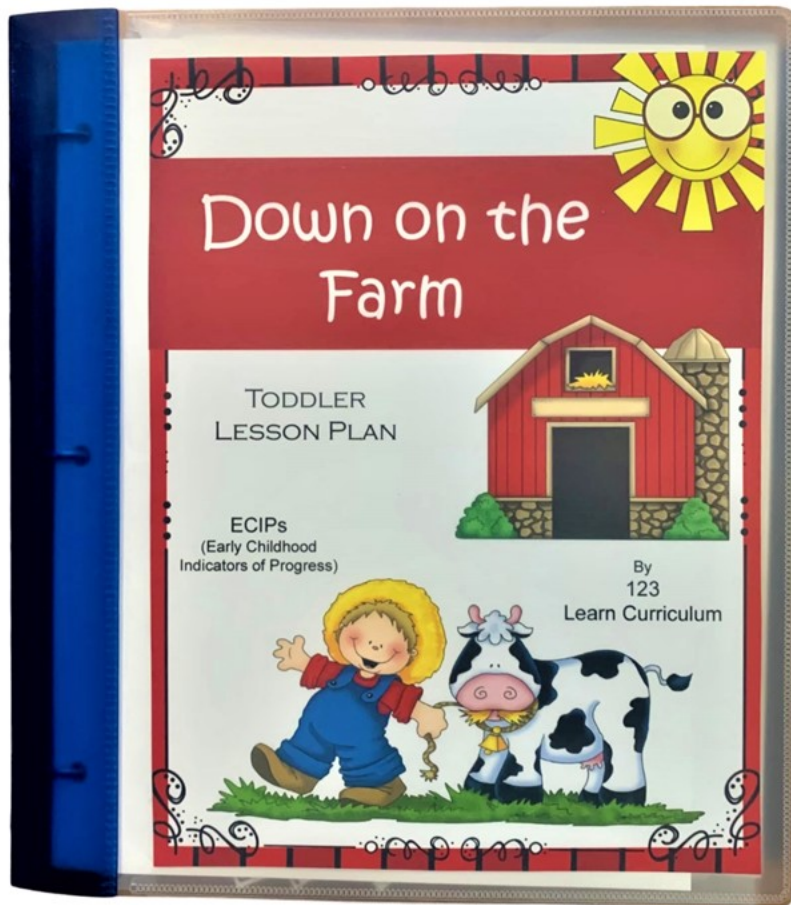

Farm toddler activities are stored in a 3-ring binder. 1". Sample shows an Avery flexible binder.

This 3-ring binder was purchased online at [Amazon.com](https://www.amazon.com).

To purchase, click on picture.

Page to add to the front of your 3-ring binder.
Print on white card stock or photo quality
paper.

Trim the white edge off and place in the front
of the 3-ring binder.

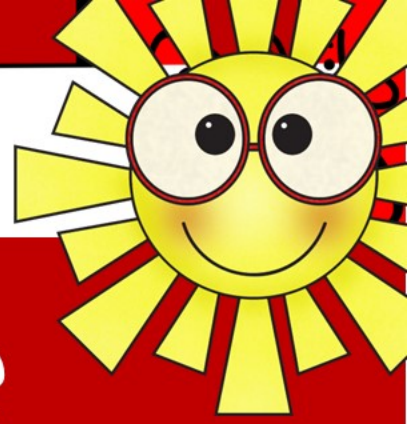

Down on the Farm

TODDLER ACTIVITIES



ECIPs
(Early Childhood
Indicators of Progress)

By
123
Learn Curriculum



Print up the 1st page of each activity in the toddler lesson plan using white card stock. Using a 3-hole punch, punch holes in the sheet and add to the 3-ring binder.

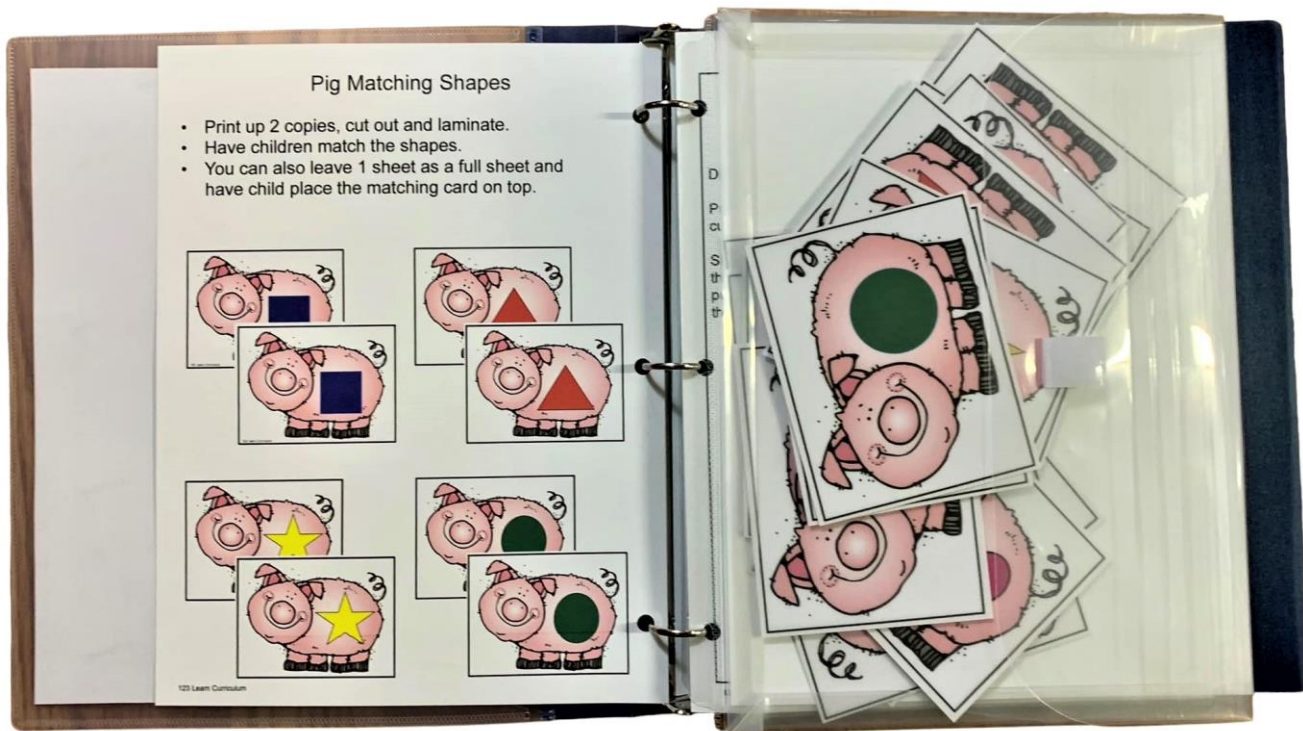

You can do a search on Amazon for a 3-ring punch.

Click on picture to purchase the one shown.

Print up activities in the toddler section and after laminating and cutting out, place in a binder pocket. Using pockets with closures will keep items from slipping out.

All items from the toddler lesson plan will fit into a 1" ring binder. The flexible covers are used because they are what it states... Flexible. 😊

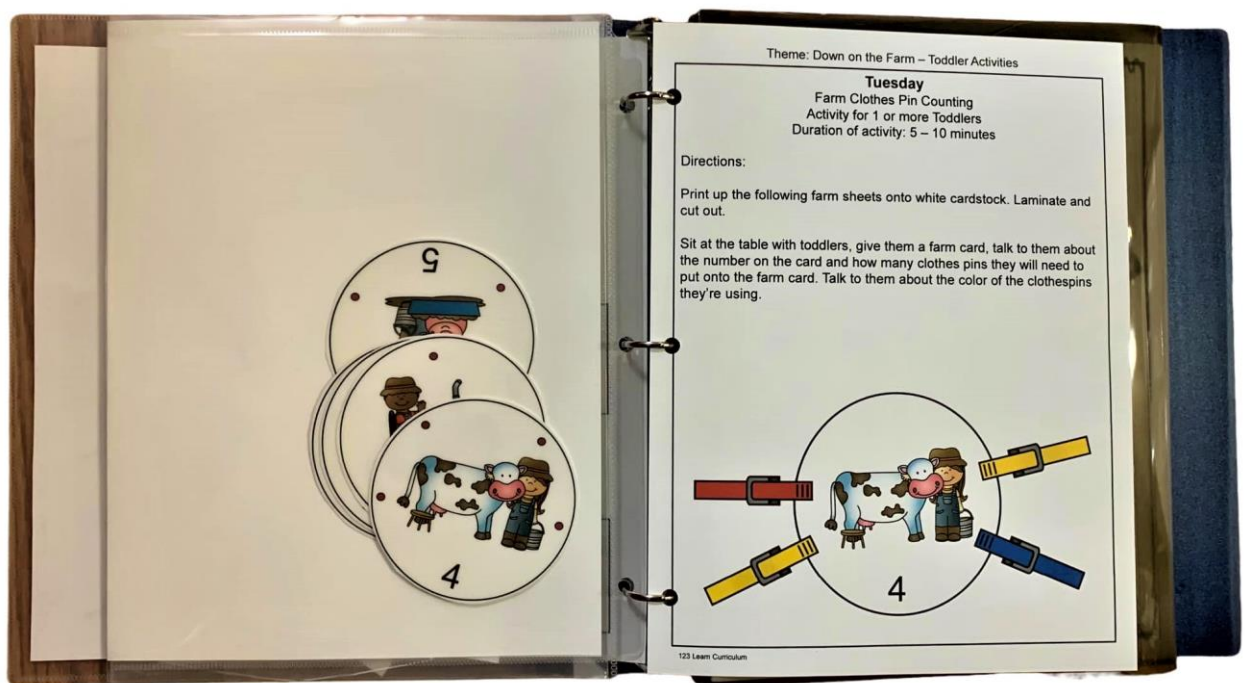

Click on picture to purchase from Amazon.com.

I receive no compensation for promoting items on amazon.com.

Theme: Down on the Farm – Toddler Activities

Tuesday

Farm Do A Dot Paint

Activity for 1 or more Toddlers

Duration of activity: 10 – 15 minutes

Domain: AL3-6: Approaches to Learning
Component: AL10-13: Processing and Utilizing Information
Subcomponent: A12 Cognitive Flexibility/Reasoning
Child considers more than one possible outcome
AL12.2 Notice's similarities and differences

Domain: Physical and Movement Development
Component: P5-6: Fine Motor
Subcomponent: P5 Dexterity Child can coordinate and control movement
of hands and fingers to grasp and manipulate objects.
P5.7 Begins to grasp crayon to scribble

- Materials:
- Do A Dot Art Markers
 - Farm Templates
 - White card stock



Directions:

Print up the farm templates onto white card stock. Sit with toddlers at the table with their template and paint. Give the children the choice of colors. Have several for them to pick from. Ask them what color they would like to use and tell them what the name of the color they picked if they don't know.

As toddlers paint the farm picture, talk to them about the picture they are painting.

123 Learn Curriculum



Barn

123 Learn Curriculum

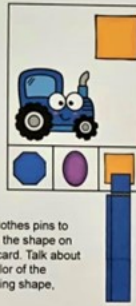

Use clothes pins to match the shape on each card. Talk about the color of the matching shape.

123 Learn Curriculum



You can save on pocket envelopes by doubling up on the activities.

Place a piece of white card stock in the pocket envelope. Place one day's activities in the front, and the next days activities in the back. With the pictures on the activities showing so you can see the activity.



The pictures and links are only an example of what you could do to make it easier to organize your toddler activities.

There are links for resources to purchase, but you can also visit your local Target or office supply store and see what they have available and see if this would work for you.

I receive no compensation for the links posted. These are provided as a resource for you.

As always, any feed back would be appreciated, or finished pictures of your lesson plan. JeanieB506@aol.com / JeanieB506@gmail.com

Down on the Farm Posters

- You have the option of color or b & w posters.
- 2 Different size posters
- Print up on white card stock.
- B & W template color
- Laminate and hang up during the down on the farm theme.



Click on the picture above to be brought to posters
in the infant section. p. 56

Additional idea: Print pages up and staple together to make a farm color book. There is a cover for the book in color and b & w. Place a blank piece of card stock in the back for a back cover. You have 2 options. Large or small posters.

When putting together the down on the farm theme, the following pages show you an example binding the preschool lesson plan.

You can put into the lesson plan the pages you want. Sample shows cover sheet printed on photo quality paper*, and a transparent binding cover. Additional sheets are printed on copy paper 24 lb. You can find items at your local office supply store or purchase directly from Amazon.

Click on picture to purchase from Amazon.



Transparent Binding Covers

* You can print the cover up on white card stock, but photo paper gives the cover a brighter color. You are covering with a transparent sheet so it will protect the ink.

Copy Paper 24 lb

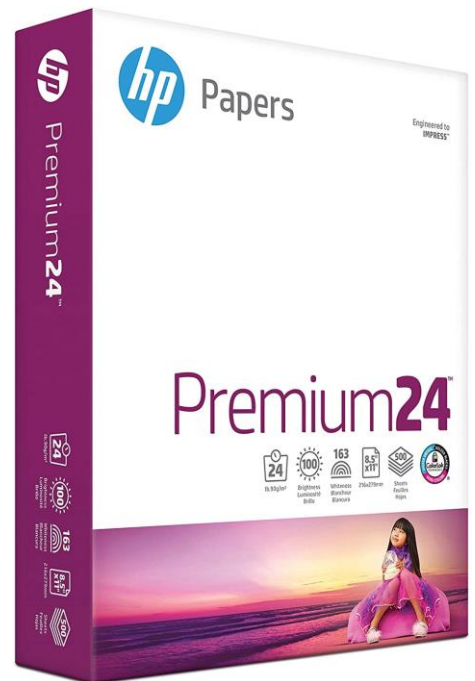

You can bound lesson plan using a binding machine that use coils or combs. Sample shows using coils. You can have this done at a local office supply store or purchase your own to use.

On the following page there are 2 samples of comb or coiled machine you can purchase directly from Amazon or go onto their search bar and type in binding machine.

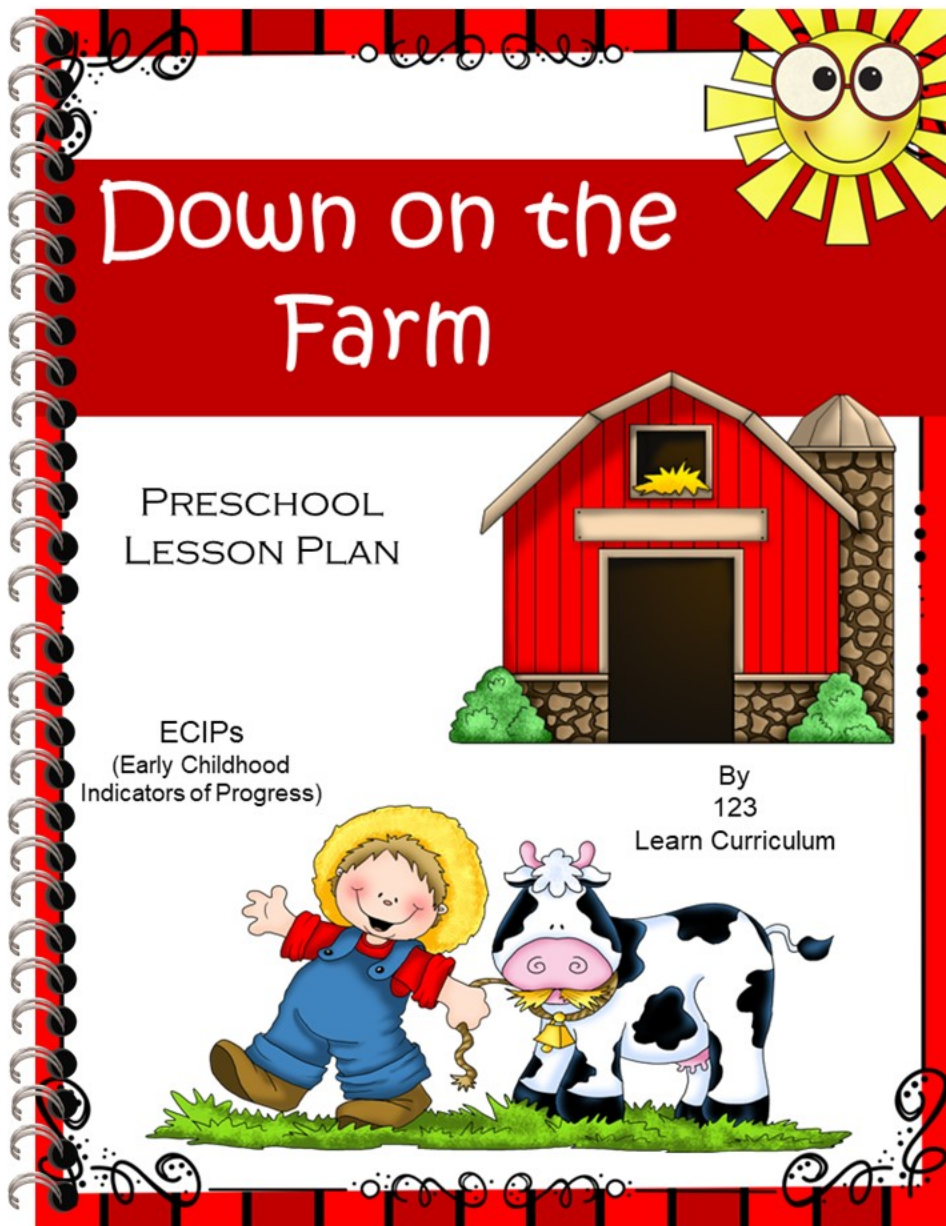

Comb machine
using combs
pictured below.



Coil machine
using coils
pictured below.



Social and Emotional Development Preschool

Domain 1: Social and Emotional Development

- Emotional Development
- Self-Concept
- Social Competence and Relationships



Social and Emotional Development ideas. These ideas can be done daily.

- Emotional Development. Greet all children each morning by name and smile.
- Focus on children's strengths and successes.
- Show children you have faith in their abilities. Encourage them to try doing things themselves and provide them with experiences for success.
- Talk with children as you go about your day. Tell them what you are doing, what you see. Point things out to them.
- Enrich children's daily routines such as mealtime, naps, etc., by sharing looks, smiles, conversations, and stories.
- Reflect their achievements in a positive but realistic manner.
- Take time to follow a child's lead. Join them in floor-time play and talk with them about their activities whenever possible. Have them share what they are doing.
- Set up an environment where initiative is more likely to lead to success than to failure.
- Well-planned and well-stocked learning centers increase the likelihood that children will engage in play and learning with each other.
- Be a positive role model. Offer children opportunities to observe you being a kind and caring person.
- Help children learn a variety of words to fully express their feelings.
- Comment on the positive things that children do.

123 Learn Curriculum

- For children who lack specific social skills, such as sharing or inviting a friend to play, provide frequent skill-building opportunities and take advantage of teachable moments.
- Respect each child's personal characteristics, while realizing that some children need more alone time than others.
- See the learning in mistakes – When a child makes a mistake turn the negative into a positive. Focus on what he/she learned from the mistake.

Each child is unique:

- Have children look at themselves in a full-length mirror. Discuss their total appearance and how they are alike or different from the other children. Help them see that no one is exactly alike.
- Blindfold the children, one at a time. Have each child feel the face and hair of classmates and then feel their own face and hair. The children will find that people feel different.
- Record each child's voice during an activity period. Children listen to the voices and guess which voice goes with each child.
- Write the children's names on a strip of paper. Compare the letters in the names.
- Play "Guess Who". Pick a child out of the classroom. Tell three clues about the person and have the children guess who the person is.
- Encourage the children to bring a favorite item from home and discuss why it is their favorite object.
- Make hand and footprints and compare them to the others in the classroom.
- Children can begin to explore racial and ethnic differences by examining differences in skin color, hair texture, and eye shape. Create graphs of how many in the class have blue eyes, black hair, etc.
- Have several children stand in a line in front of the class. Name the child who is first, second, third and so on. Ask the children to change positions. Then have each child in line name his or her new position. To vary the activity, have the children at their seats name each child in line and describe his or her position.
- Have the children make a self-portrait using a paper plate. Give them yarn for hair and allow them to add their features to the plate.
- Supply each child with an empty Pringles or similar can and a sheet of construction paper. Have each child decorate the construction paper and glue it to the can to create a time capsule. Encourage the children to fill the can with personal items, such as a picture of himself, a drawing, etc. Replace the lids and store the time capsules until the end of the year.

- Use a magnifying glass to look at their hair, nails and skin.
- Tape a piece of paper to the wall. Place a lamp or overhead projector in front of the paper so that the light shines on it. In a learning center, have a child sit sideways in the light of the lamp. Trace the child's silhouette onto the paper. Cut out. Have the child look through magazines and cut out pictures of things that he or she likes. They can then glue the pictures to their silhouettes as collages.

Each child's body grows:

- Ask the children what they want to be when they grow up and why.
- Have the children think of some things they can't do now but can do when they grow older. What are some things they can do now that they couldn't do when they were younger?
- Role play the growth process from baby to father or mother to grandparent. The child can interpret the process as he or she goes along. Children can also develop a short play about the family.
- Teachers can help children appreciate their growing skills and abilities by pointing out, for example, that they can run, throw a ball, walk on tiptoe, share materials, control a crayon when drawing, etc.

Each child is part of a family:

- Have the children name some of the rules their family has and discuss why these rules are important. Discuss the jobs that need to be done at home. Make sure children understand that families must work together.
- Make a sharing collage. Use fabric scraps, paper scraps and other materials. Have children color and paste these materials on a large sheet of mural paper.
- Role play the growth process from baby to father or mother to grandparent. The child can interpret the process as he or she goes along. Children can also develop a short play about the family.
- Take the children's fingerprints twice. Leave one alone, but let the children use the other one to paint on. Give the children both copies to send home.

People have different feelings and emotions:

- Ask the children to make faces of a certain emotion (sad, mad, happy, etc.) Provide some scenarios for these emotions (falling off a bike-sad, someone hitting them-mad, etc.).
- Have children cut out pictures of faces from magazines showing different facial expressions.

Monday – Friday

Every morning – greet children by name and with a smile. Have eye contact and show children that you are happy to see them each morning.

Domain: Social and Emotional Development
Component: S6-8: Social Understanding and Relationships

Subcomponent: S7 Building relationships:
 Child establishes and sustains relationships with others

S7.8 Shares information and participates in activities with adults and peers



Monday – Friday

Everyday sing or play music for children. You might not have the greatest voice, but children can connect, bond and this is a fun way to interact with all children.

Domain: The Arts
Components A3-4: Using the Arts to express Ideas and Emotions

Subcomponent: A3 Using Art:
 Child demonstrates interest and emotions in artistic expression

A3.5 Elects to spend time in artistic express with purpose and analyzes their work



Spend time reading to children every day. Reading to children set the foundation for later independent reading. Benefits include boosting school readiness - reading is one of the easiest ways to increase school readiness. When you read to children, you're helping to build their vocabulary, language and literacy skills, while improving concentration, curiosity and memory. Research shows that the more words a child is exposed to, the better prepared they are to eventually start reading on their own.

Domain: Language Literacy Communications

Component: L4-8: Emergent Reading

Subcomponent: L4 Motivation, Engagement:

Child has an interest in and sustained attention for literacy acts

3-4 years

L4.10 Shows persistence with longer and more complex narratives and informational text

L4.11 Offers a personal response to stories read aloud

4-5 K-Readiness

L4.12 Actively participates in reading activities with enjoyment and purpose

L4.13 Retells familiar stories using the book as a guide

As you spend each day singing to the children, they are benefiting in so many ways. Having a special song for waking up, and other routine transitions and activities helps them know what comes next.

Language – through your singing, you are introducing a whole new vocabulary. Rhyming songs – children in time will recognize rhymes. Listening skills – like reading, singing is an activity that requires listening. There are so many benefits that you just might want to grab that Mic and go for it. ☺

Domain: Language, Literacy and Communications

Component: LLC 1-2: Listening and Understanding; Receptive Language

Subcomponent: L1 Language Comprehension:

Child understands the meaning of words and phrases (receptive) and uses those words and phrases to communicate effectively (expressive)

L1.13 Follows directions that involve two or more steps



Monday – Friday Planned Activities

- Keep circle time consistent.
- Average time for circle time is 5 to 10 minutes.
- Keep children engaged by asking open ended questions.
- Repetitive text encourages children to join in on familiar parts.
- Use different voices for the different characters.



Circle Time

Book Choice: Mrs. Wishy-Washy's Farm
 Greeting: A Circle of Friends
 Daily Message
 Song: Farm Sounds

Talk about what life is like living on a farm. There is a page in the lesson plan describing a farmer's life. This should be printed up and added to your lesson plan book for easy viewing. Talk about the crops farmers grow and animals they raise.

Discuss the different types of farmers. Do they raise crops or animals?

Print up what is your favorite farm animal activity

Goals:

- Learn about what animals live on a farm.
- See what everyone's favorite farm animal is.
- Count each farm animal and see which animal is the favorite.

Poem: Farm Counting Song

Print up posters.

- Support your Local Farmer.
- Farm Life
- Farm Machinery and Tools
- Farm Facts
- Different Animal Facts

Print up the following posters and hang up during the week in your circle time area.

Letter of the Week: Y
Number of the Week: 4
Color of the Week: Pink
Shape of the Week: Triangle
Sign Language: Cow



Daily Jobs

Suggested daily jobs to do during circle time.

- Day of the Month
- Weather of the Day
- Dinosaur or Volcano Graphing

Circle time for children under three years old should be voluntary and not forced.

Use circle time to inform the children the theme for the week and all the activities that lay ahead for the day.

Monday Small Group

Small group is an important time to teach skills. Play games that include numbers and letters to reinforce. Writing, working in journals, sorting colors and shape recognition. Adjust your daily schedule



Reading

Read: My Friends on the Farm from preschool lesson plan.

- Print up correct book you would like to use.
- You have 2 options. With or without printed words to print.
- Print up teachers copy.

Writing

Write: Have children practice writing words from My Friends on the Farm.

- You will be using this book for the week to practice writing words, so keep that in mind when having children practice writing words. You can also have children write on index cards or paper.

Activity: Down on the Farm Color Match

You have the option of using color or b & w templates. Ahead of time decide which template you will use, and will you use stickers, paint daubers or play doh.

Tuesday Small Group



Reading

Read: My Friends on the Farm.

- Read book together as a group.
- Have children take time to color some of the book and write a word in the book.

Writing

Write: Print up colored sheets, laminate for on the farm tracing. You also have the option to use b & w copies for children to do and place in their Friday folders.

Print up additional b & w sheets and keep items in writing center.

Activity: Down on the Farm Cube Pictures

You will need Mathlink Cubes. You can click on the picture on the direction page. You will Need to print up templates and laminate ahead of time. Children will be building and counting in this activity. Using small motor skills and math. You also have the option to have children color patterns. Read directions and decide the option you will use.



ECIPS: Language, Literacy and Communications
 Physical and Movement Development

Mathematics - Cognitive

Wednesday Small Group



Small groups are a highly-effective instructional method that allows you to target your instruction to meet the needs and skills of each student in your classroom.

Reading

Read: My Friends on the Farm..

- Read book together as a group.
- Have children take time to color some of the book and write a word in the book.

Activity: Farm Bingo

- Print up farm bingo templates and have everything prepped and ready to go. Decide what you are going to use as bingo cover up. Read full directions to have prepped and ready.

Writing

Write: If I Were a Farmer worksheet.

- Ask children to draw a picture of themselves as a farmer. What would they need to use? Tractor, pitchfork, horse, etc.
- Have children write what their favorite farm animal is. Have children look through the vocabulary words located in the writing center to see how to spell their favorite animal.

Thursday Small Group

Reading

Read: My Friends on the Farm book.

- Read book together as a group.
- Have children take time to color some of the book and write a word in the book.

Activity: Farm Play Doh Mats

- Print up play doh mats and laminate.
- Have available different colors of play doh.
- You can show children how to roll different colors to form the pictures.

ECIPS:
Language, Literacy and Communications
Physical and Movement Development

Writing

Write: Farm Q-Tip Painting

- Only prepping you will need is printing sheets onto white card stock.
- Have paint available along with Q-Tips.
- Encourage children to paint with the tip of the Q-Tips by dotting each circle.



Friday Small Group



The most important thing about small group is that you choose hands-on activities that are engaging and fun.

Reading

Read: My Friends on the Farm.

- Read book together as a group.
- Have children take time to color some of the book and write a word in the book.
- Finish any pages that need writing or coloring to finish the book. Send home today.

Activity: Farm Graph

Print up sheet onto regular copy paper. You will need crayons or markers. Have children start with the 1st picture at the top of the graph. Color the barn by the graph and then have them go above and color how many barns that are up in the group of farm pictures. There is one picture so the children will color one square in the graph.

Continue with each children until they are done coloring all picture and filling in the graph.



ECIPS:
Language, Literacy and Communications
Physical and Movement Development

Mathematics - Cognitive

Down on the Farm Monday Advance Preparation

- Locate the book you would like to use for the week during circle time. Theme related and something age appropriate. You can check the book list included with this theme.
- Stick with one book for the week for circle time but have a selection of theme related books in your reading center.
- Ahead of time print up the wall charts for the letter Y, number 4, color pink and shape triangle. Decide if you're going to use color or B & W. If using B & W, color them ahead of time. Hang the wall charts in the playroom or around your circle area. Use B & W sheets for additional color sheets for children.
- Purchase any necessary ingredients for cooking or snack activities you wish to do during the week.
- Print up worksheets you will need for the day.
- Make sure to have all craft materials on hand for any projects you will be doing this week.



Down on the Farm Monday

- Welcome each child – Start circle time on Monday letting children know what the new theme is for the week. Down on the Farm. Encourage children to share anything they know about farm life. Print up down on the farm posters. Hang up on wall or make a book. The posters come in color and b & w so you can make a coloring book for each child.

- Color Time Greeting: A Circle of Friends
- Introduce the letter of the week:

Letter Chant:

Raise your hands up high – reach for the sky.
Reach your hands down low – tickle your toes.
Put your hands to your side and slap your thighs.
Letters, letters, Letters have names.
What is the name of this letter?

- On a small dry eraser board, write down the letter Y. Ask the children to tell you the letter, and ask them if it is an upper case or a lower-case y. Once they tell you the letter, erase it, and write it small in the upper right-hand corner. Ask them to give you words that start with the letter d. Sound them out, so they hear the y sound. Draw the picture. (You don't have to be an artist; the children enjoy your effort). You can also use the following sheets for d words.
- If you do "jobs" during circle time, you can do those now. (Examples: What's the weather outside? What is today's day? Calendar).
- Interactive Song: Farm Sound Puppets

Print the following cover
on white card stock.



Down on the Farm

PRESCHOOL
LESSON PLAN



ECIPs
(Early Childhood
Indicators of Progress)

By
123
Learn Curriculum



Social and Emotional Development Preschool

Domain 1: Social and Emotional Development

- Emotional Development
- Self-Concept
- Social Competence and Relationships



Social and Emotional Development ideas. These ideas can be done daily.

- Emotional Development. Greet all children each morning by name and smile.
- Focus on children's strengths and successes.
- Show children you have faith in their abilities. Encourage them to try doing things themselves and provide them with experiences for success.
- Talk with children as you go about your day. Tell them what you are doing, what you see. Point things out to them.
- Enrich children's daily routines such as mealtime, naps, etc., by sharing looks, smiles, conversations, and stories.
- Reflect their achievements in a positive but realistic manner.
- Take time to follow a child's lead. Join them in floor-time play and talk with them about their activities whenever possible. Have them share what they are doing.
- Set up an environment where initiative is more likely to lead to success than to failure.
- Well-planned and well-stocked learning centers increase the likelihood that children will engage in play and learning with each other.
- Be a positive role model: Offer children opportunities to observe you being a kind and caring person.
- Help children learn a variety of words to fully express their feelings.
- Comment on the positive things that children do.

- For children who lack specific social skills, such as sharing or inviting a friend to play, provide frequent skill-building opportunities and take advantage of teachable moments.
- Respect each child's personal characteristics, while realizing that some children need more alone time than others.
- See the learning in mistakes – When a child makes a mistake turn the negative into a positive. Focus on what he/she learned from the mistake.

Each child is unique:

- Have children look at themselves in a full-length mirror. Discuss their total appearance and how they are alike or different from the other children. Help them see that no one is exactly alike.
- Blindfold the children, one at a time. Have each child feel the face and hair of classmates and then feel their own face and hair. The children will find that people feel different.
- Record each child's voice during an activity period. Children listen to the voices and guess which voice goes with each child.
- Write the children's names on a strip of paper. Compare the letters in the names.
- Play "Guess Who". Pick a child out of the classroom. Tell three clues about the person and have the children guess who the person is.
- Encourage the children to bring a favorite item from home and discuss why it is their favorite object.
- Make hand and footprints and compare them to the others in the classroom.
- Children can begin to explore racial and ethnic differences by examining differences in skin color, hair texture, and eye shape. Create graphs of how many in the class have blue eyes, black hair, etc.
- Have several children stand in a line in front of the class. Name the child who is first, second, third and so on. Ask the children to change positions. Then have each child in line name his or her new position. To vary the activity, have the children at their seats name each child in line and describe his or her position.
- Have the children make a self-portrait using a paper plate. Give them yarn for hair and allow them to add their features to the plate.
- Supply each child with an empty Pringles or similar can and a sheet of construction paper. Have each child decorate the construction paper and glue it to the can to create a time capsule. Encourage the children to fill the can with personal items, such as a picture of himself, a drawing, etc. Replace the lids and store the time capsules until the end of the year.

- Use a magnifying glass to look at their hair, nails and skin.
- Tape a piece of paper to the wall. Place a lamp or overhead projector in front of the paper so that the light shines on it. In a learning center, have a child sit sideways in the light of the lamp. Trace the child's silhouette onto the paper. Cut out. Have the child look through magazines and cut out pictures of things that he or she likes. They can then glue the pictures to their silhouettes as collages.

Each child's body grows:

- Ask the children what they want to be when they grow up and why.
- Have the children think of some things they can't do now but can do when they grow older. What are some things they can do now that they couldn't do when they were younger?
- Role play the growth process from baby to father or mother to grandparent. The child can interpret the process as he or she goes along. Children can also develop a short play about the family.
- Teachers can help children appreciate their growing skills and abilities by pointing out, for example, that they can run, throw a ball, walk on tiptoe, share materials, control a crayon when drawing, etc.

Each child is part of a family:

- Have the children name some of the rules their family has and discuss why these rules are important. Discuss the jobs that need to be done at home. Make sure children understand that families must work together.
- Make a sharing collage. Use fabric scraps, paper scraps and other materials. Have children color and paste these materials on a large sheet of mural paper.
- Role play the growth process from baby to father or mother to grandparent. The child can interpret the process as he or she goes along. Children can also develop a short play about the family.
- Take the children's fingerprints twice. Leave one alone, but let the children use the other one to paint on. Give the children both copies to send home.

People have different feelings and emotions:

- Ask the children to make faces of a certain emotion (sad, mad, happy, etc.) Provide some scenarios for these emotions (falling off a bike-sad, someone hitting them-mad, etc.).
- Have children cut out pictures of faces from magazines showing different facial expressions.

Lesson Plan for Preschoolers is done using the book – Mrs. Wishy-Washy's Farm by Joy Cowley

You can use the same concept and ideas with a different book. You can locate the above book through Scholastics or Amazon.com. (Also check your local library).

Thank you
Jean

Print up the following page onto white card stock and hang up on the bulletin board if you would like to give a visual to the parents on the book you are reading for the down on the farm theme.

You will also have additional down on the farm related books to read during the week. Check the book list included with this lesson plan.

BOOK WE'RE READING

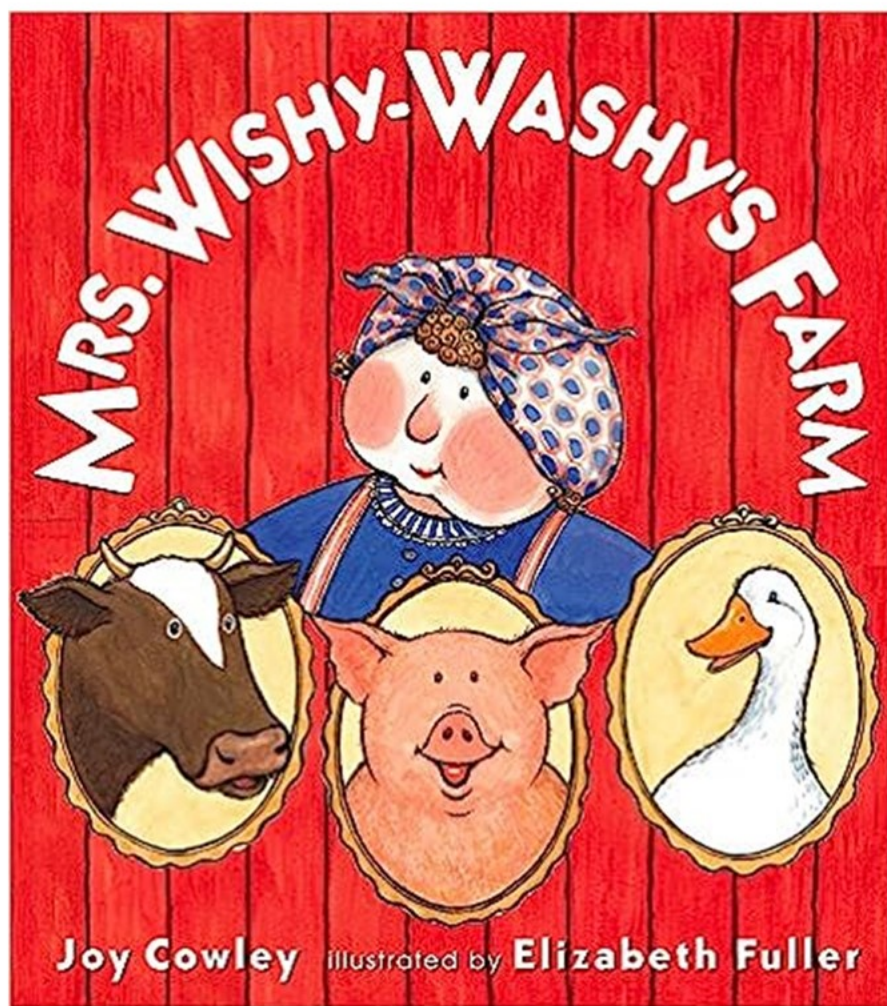

PRESCHOOL BOOK

MRS. WISHY-WASHY'S FARM

BY JOY COWLEY

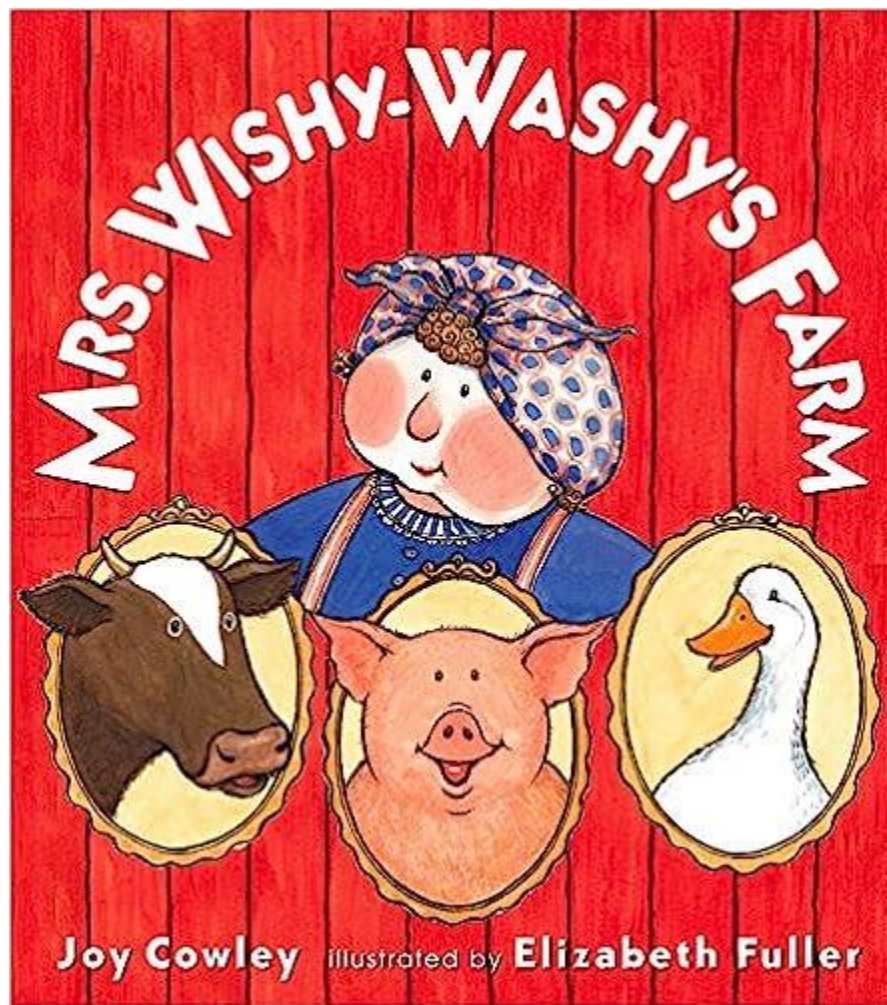

Click on picture above to go to Amazon.com to purchase book. Once you click on book, Click on allow and you will be taken directly to the book to purchase.

Monday – Friday

Every morning – greet children by name and with a smile. Have eye contact and show children that you are happy to see them each morning.

Domain: Social and Emotional Development
Component: S6-8: Social Understanding and Relationships

Subcomponent: S7 Building relationships:

Child establishes and sustains relationships with others

S7.8 Shares information and participates in activities with adults and peers



Spend time reading to children every day. Reading to children set the foundation for later independent reading. Benefits include boosting school readiness - reading is one of the easiest ways to increase school readiness. When you read to children, you're helping to build their vocabulary, language and literacy skills, while improving concentration, curiosity and memory. Research shows that the more words a child is exposed to, the better prepared they are to eventually start reading on their own.

Domain: Language Literacy Communications

Component: L4-8: Emergent Reading

Subcomponent: L4 Motivation, Engagement:

Child has an interest in and sustained attention for literacy acts

3-4 years

L4.10 Shows persistence with longer and more complex narratives and informational text

L4.11 Offers a personal response to stories read aloud

4-5 K-Readiness

L4.12 Actively participates in reading activities with enjoyment and purpose

L4.13 Retells familiar stories using the book as a guide

Monday – Friday

Everyday sing or play music for children. You might not have the greatest voice, but children can connect, bond and this is a fun way to interact with all children.

Domain: The Arts

Components A3-4: Using the Arts to express Ideas and Emotions

Subcomponent: A3 Using Art:

Child demonstrates interest and emotions in artistic expression

A3.5 Elects to spend time in artistic express with purpose and analyzes their work



As you spend each day singing to the children, they are benefiting in so many ways. Having a special song for waking up, and other routine transitions and activities helps them know what comes next.

Language – through your singing, you are introducing a whole new vocabulary. Rhyming songs – children in time will recognize rhymes. Listening skills – like reading, singing is an activity that requires listening. There are so many benefits that you just might want to grab that Mic and go for it. 😊

Domain: Language, Literacy and Communications

Component: LLC 1-2: Listening and Understanding; Receptive Language

Subcomponent: L1 Language Comprehension:

Child understands the meaning of words and phrases (receptive) and uses those words and phrases to communicate effectively (expressive)

L1.13 Follows directions that involve two or more steps



Circle Time

Circle time is done usually in the morning, first thing before you start your preschool day. Circle time is also called morning meeting or community circle.

The purpose of circle time is to introduce children to pre-k concepts using hands-on teaching methods, songs, movement, fingerplays, and flannel board figures and stories. In addition to a daily concept, you can also discuss the weather, calendar and name shapes.

Create Ground Rules

Generally, pupils love circle time and the opportunities it gives them to talk about themselves and one another, but it is still essential to establish some basic rules for all to follow. The rules that you apply when facilitating circle time in your classroom should certainly be understood by all involved and ideally, they should be agreed by everyone too, although this will depend to some extent on the age of the children. The reality of a well-run circle is such that very few rules are needed. You may like to work to the following as a minimum:

- Only one person is to speak at any one time.
- It's perfectly acceptable to 'pass' on anything you don't want to talk about.
- All circle members will always show respect for one another.

Preschool Lesson Plan – Down on the Farm – Letter of the Week - Y

Circle Time

Week of:

Circle time	
Circle time Greeting Daily Message Read Aloud Interactive Writing Shared Reading Music	

Preschool Lesson Plan – Down on the Farm – Letter of the Week - Y

Circle Time

Week of:

123 Learn Curriculum

Circle time	
Greeting	A Circle of Friends
Daily Message	Good morning boys and girls. Today is _____. Today we're going to talk about farm life.
Read Aloud	Mrs. Wishy-Washy's Farm by Joy Cowley
Interactive Writing	Practice writing the letter Y on a small dry eraser board. (You can also practice writing the letter on the floor or in the air).
Shared Reading	On Friday let one of the children read the book to the group.
Music	Farm Sounds

ECIPs Domain: Social and Emotional Component: Social Understanding and Relationships:

Subcomponent S7 Building relationships: Child establishes and sustains relationships with others

S7.6 Seeks out familiar adults and children for conversation and play

S7.8 Shares information and participates in activities with adults and peers

S7.9 Builds friendship through play, learning activities and conversation with peers

Domain: Language, Literacy and Communications Component: Emergent Reading

Subcomponent L4 Motivation, engagement: Child has an interest in and sustained attention for literacy acts

L4.9 Focuses on a book while listening to the reader

L4.11 Offers a personal response to stories read aloud

L4.12 Actively participates in reading activities with enjoyment and purpose Build's friendship through play, learning activities and conversation with peers

K 0.1.10.10 Actively participates in group reading activities with purpose and understanding including the appropriate selection of text for personal enjoyment, interest and academic tasks

Monday – Friday Planned Activities

- Keep circle time consistent.
- Average time for circle time is 5 to 10 minutes.
- Keep children engaged by asking open ended questions.
- Repetitive text encourages children to join in on familiar parts.
- Use different voices for the different characters.



Circle Time

Book Choice: Mrs. Wishy-Washy's Farm

Greeting: A Circle of Friends

Daily Message

Song: Farm Sounds

Talk about what life is like living on a farm. There is a page in the lesson plan describing a farmer's life. This should be printed up and added to your lesson plan book for easy viewing. Talk about the crops farmers grow and animals they raise.

Discuss the different types of farmers. Do they raise crops or animals.

Print up what is your favorite farm animal activity

Goals:

- Learn about what animals live on a farm.
- See what everyone's favorite farm animal is.
- Count each farm animal and see which animal is the favorite.

Song: Farm Counting Poem

Print up posters.

- Support your local Farmer
- Farm Life
- Farm Machinery and Tools
- Farm Facts
- Different Animal Facts

Print up the following posters and hang up during the week in your circle time area.

Letter of the Week: Y

Number of the Week: 4

Color of the Week: Pink

Shape of the Week: Triangle

Sign Language: Cow

Daily Jobs

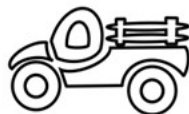

Suggested daily jobs to do during circle time.

- Day of the Month
- Weather of the Day
- Cow and Pig Graphing

Circle time for children under three years old should be voluntary and not forced.

Use circle time to inform the children the theme for the week and all the activities that lay ahead for the day.

ECIPs Domain: Social and Emotional Component: Social Understanding and Relationships:
Subcomponent S7 Building relationships: Child establishes and sustains relationships with others

Domain: Language, Literacy and Communications Component: Emergent Reading
Subcomponent L4 Motivation, engagement: Child has an interest in and sustained attention for literacy acts

Monday Small Group

Small group is an important time to teach skills. Play games that include numbers and letters to reinforce. Writing, working in journals, sorting colors and shape recognition. Adjust your daily schedule



Reading

Read: My Friends on the Farm

- Print up correct book you would like to use.
- You have 2 options. With or without printed words to print.
- Print up teachers copy.

Writing

Write: Have children practice writing words from the My Friends on the Farm.

- You will be using this book for the week to practice writing words, so keep that in mind when having children practice writing words.

Activity: Down on the Farm Color Match

You have the option of using color or b & w templates. Ahead of time decide which template you will use and will you use stickers, paint daubers or play dough.



Tuesday Small Group

Reading

Read: My Friends on the Farm.

- Read book together as a group.
- Have children take time to color some of the book and write a word in the book.

Writing

Write: Print up colored sheets, laminate for the on the farm tracing. You also have the option to use b & w copies for children to do and place in their Friday folders.

- Print up additional b & w sheets and keep items in writing center.

Activity: Down on the Farm Cube Pictures



You will need Mathlink Cubes. You can click on the picture on the direction page. You will need to print up templates and laminate ahead of time. Children will be building and counting in this activity. Using small motor skills and math. You also have option to have children color patterns. Read directions and decide the option you will use.

ECIPS:
Language, Literacy and Communications
Physical and Movement Development

Mathematics - Cognitive

Wednesday Small Group



Small groups are a highly-effective instructional method that allows you to target your instruction to meet the needs and skills of each student in your classroom.

Reading

Read: My Friends on the Farm..

- Read book together as a group.
- Have children take time to color some of the book and write a word in the book.

Activity: Farm Bingo

- Print up farm bingo templates and have everything prepped and ready to go. Decide what you are going to use as bingo cover up. Read full directions to have prepped and ready.

Writing

Write: If I Were a Farmer worksheet.

- Ask children to draw a picture of themselves as a farmer. What would they need to use? Tractor, pitchfork, horse, etc.
- Have children write what their favorite farm animal is. Have children look through the vocabulary words located in the writing center to see how to spell their favorite animal.

Thursday Small Group

Reading

Read: My Friends on the Farm book.

- Read book together as a group.
- Have children take time to color some of the book and write a word in the book.

Activity: Farm Play Doh Mats

- Print up play doh mats and laminate.
- Have available different colors of play doh.
- You can show children how to roll different colors to form the pictures.

ECIPS:
Language, Literacy and Communications
Physical and Movement Development



Writing

Write: Farm Q-Tip Painting

- Only prepping you will need is printing sheets onto white card stock.
- Have paint available along with Q-Tips.
- Encourage children to paint with the tip of the Q-Tips by dotting each circle.



Friday Small Group

The most important thing about small group is that you choose hands-on activities that are engaging and fun.



Reading

Read: My Friends on the Farm.

- Read book together as a group.
- Have children take time to color some of the book and write a word in the book.
- Finish any pages that need writing or coloring to finish the book. Send home today.

Writing

Write: Farm Letter Match

- You have color and b & w templates.
- You will print up color template on white cardstock. Prep the stickers ahead of time by writing the uppercase alphabet on them.
- Children will get a set of alphabet to do their page.
- If using b & w, print up and have children color the picture before adding alphabet stickers. (Matching to the lowercase letter).
- B & W template gives children the option of using their writing skills by coloring the picture. Writing and small motor skills is used with this activity.



Activity: Farm Graph

Print up sheet onto regular copy paper. You will need crayons or markers. Have children start with the 1st picture at the top of the graph. Color the barn by the graph and then have them go above and color how many barns that are up in the group of farm pictures. There is one picture so the children will color one square in the graph.

Continue with each children until they are done coloring all picture and filling in the graph.



ECIPS:
Language, Literacy and Communications
Physical and Movement Development

Mathematics - Cognitive

Down on the Farm

Monday

Advance Preparation

- Locate the book you would like to use for the week during circle time. Theme related and something age appropriate. You can check the book list included with this theme.
- Stick with one book for the week for circle time but have a selection of theme related books in your reading center.
- Ahead of time print up the wall charts for the letter Y, number 4, color pink and shape triangle. Decide if you're going to use color or B & W. If using B & W, color them ahead of time. Hang the wall charts in the playroom or around your circle area. Use B & W sheets for additional color sheets for children.
- Purchase any necessary ingredients for cooking or snack activities you wish to do during the week.
- Print up worksheets you will need for the day.
- Make sure to have all craft materials on hand for any projects you will be doing this week.



Down on the Farm

Monday

- Welcome each child – Start circle time on Monday letting children know what the new theme is for the week. Down on the Farm. Encourage children to share anything they know about farm life. Print up down on the farm posters. Hang up on wall or make a book. The posters come in color and b & w so you can make a coloring book for each child.
- Color Time Greeting: A Circle of Friends
- Introduce the letter of the week:

Letter Chant:

Raise your hands up high – reach for the sky.
Reach your hands down low – tickle your toes.
Put your hands to your side and slap your thighs.
Letters, letters, Letters have names.
What is the name of this letter?

- On a small dry eraser board, write down the letter Y. Ask the children to tell you the letter, and ask them if it is an upper case or a lower-case y. Once they tell you the letter, erase it, and write it small in the upper right-hand corner. Ask them to give you words that start with the letter d. Sound them out, so they hear the y sound. Draw the picture. (You don't have to be an artist; the children enjoy your effort). You can also use the following sheets for d words.
- If you do “jobs” during circle time, you can do those now. (Examples: What's the weather outside? What is today's day? Calendar).
- Interactive Song: Farm Sound Puppets

A Circle of Friends

We've joined together as classmates.
As the new day begins.
A day full of learning.
While we become friends.

We'll share and be kind.
As we work and we play.
Ands our friendship will grow,
With each passing day!



Farm Sounds

(Sung to: "The Wheels on the Bus")

The cows in the barn go moo, moo, moo,
Moo, moo moo – moo, boo, moo.

The cows in the barn go moo, moo, moo,
All around the farm.

Additional verses:

The pigs in the pen go oink, oink, oink;
The hens in the coops go cluck, cluck, cluck;
The rooster on the fence goes cock-a doodle-do
The ducks on the pond go quack, quack, quack;
The lambs on the hill go baa, baa, baa;
The bunnies in the hutch go;
(Silently wiggle nose with finger).



Farm Sounds Puppets

- Print up on white card stock.
- Trim – Laminate.
- Attach a small piece of Velcro to the back of each piece for felt board. (rough side)
- You can also print up, laminate and tape to a craft stick. Let children use during your farm sound song.

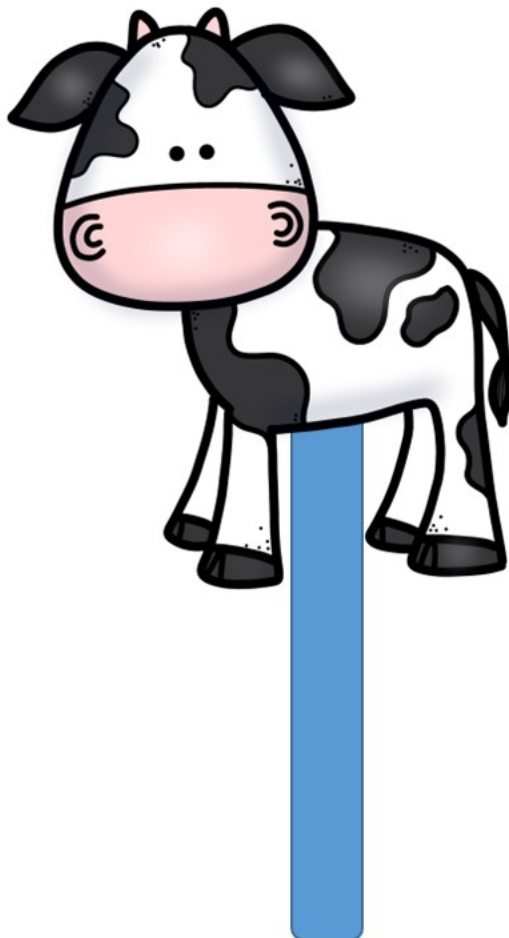

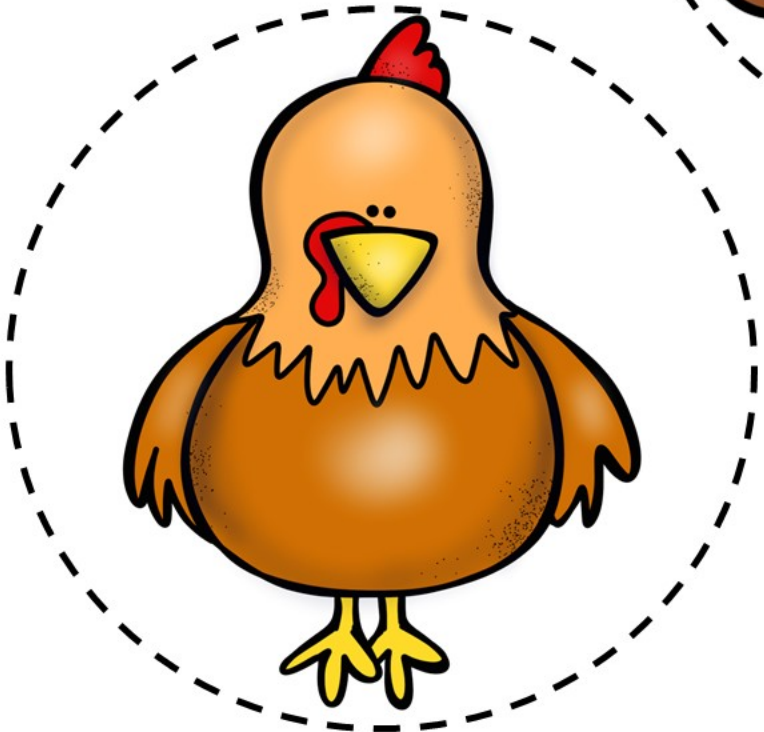
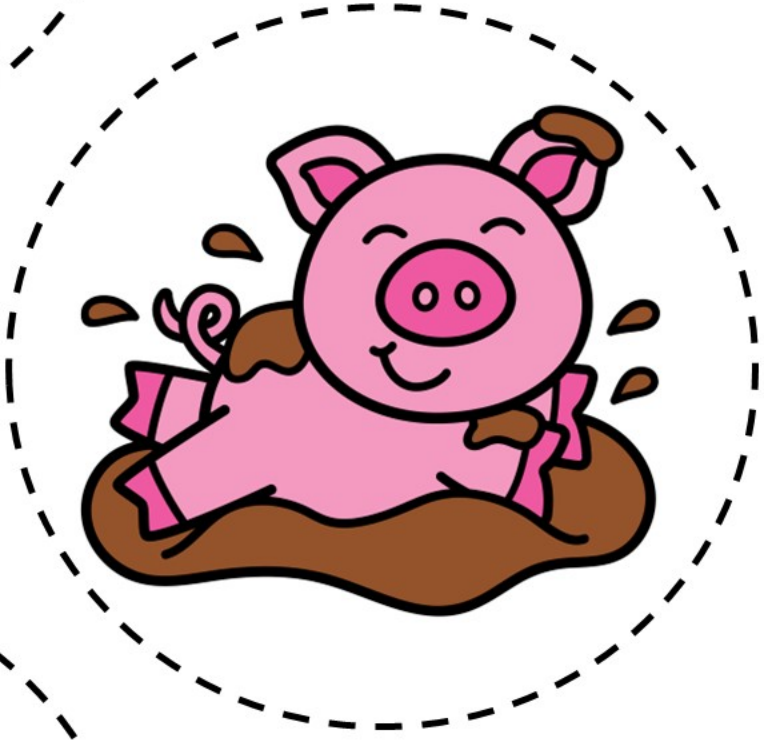
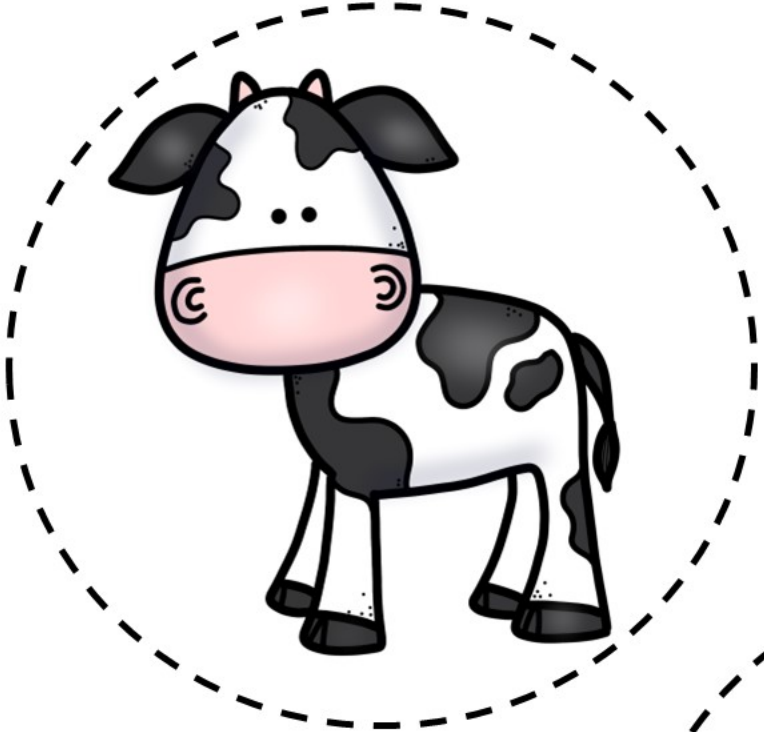

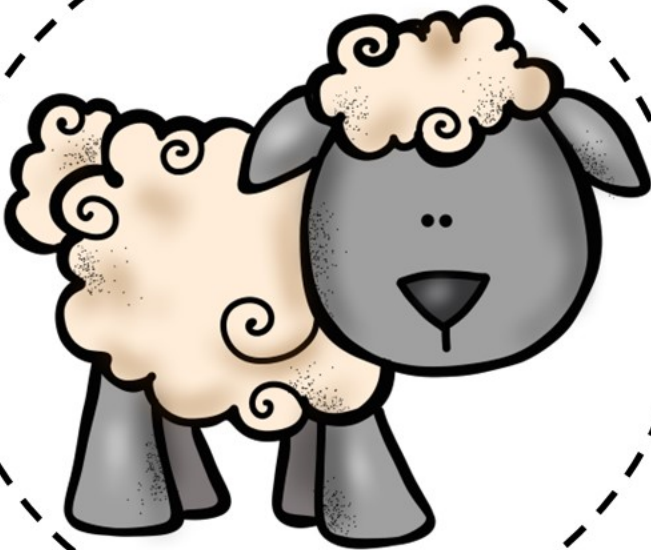
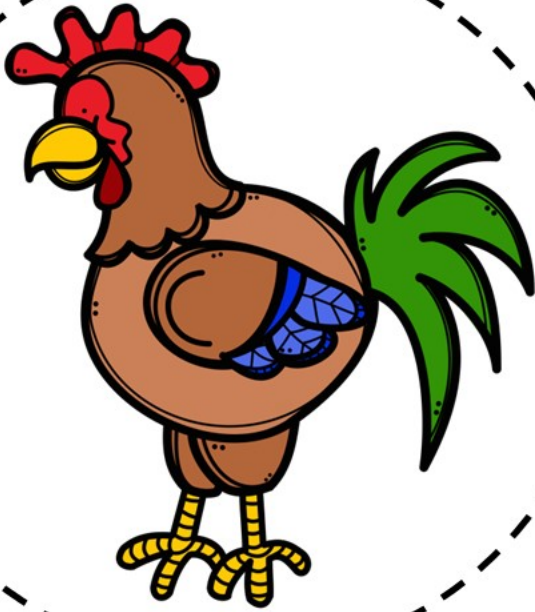

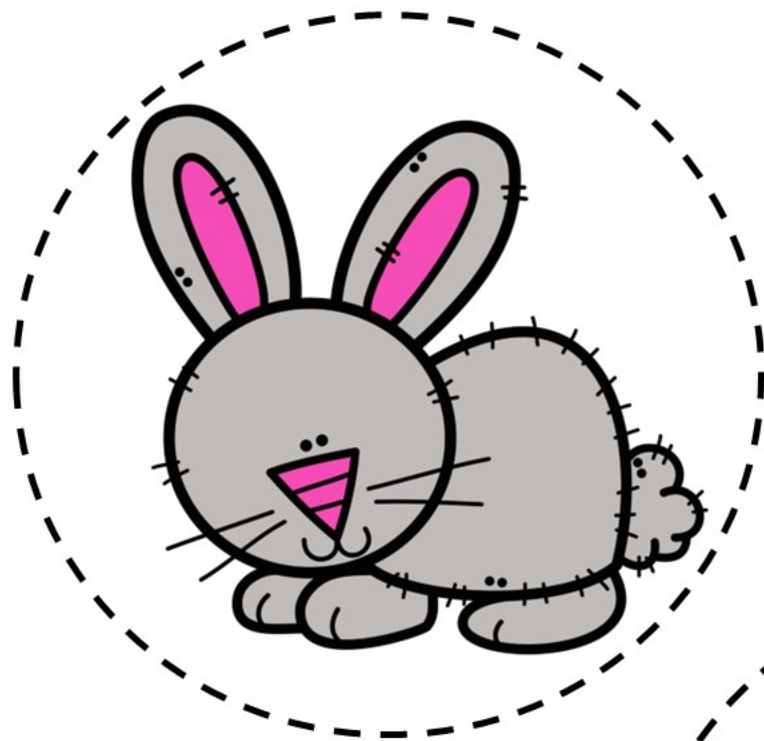

Farm Sounds Puppets

In B & W

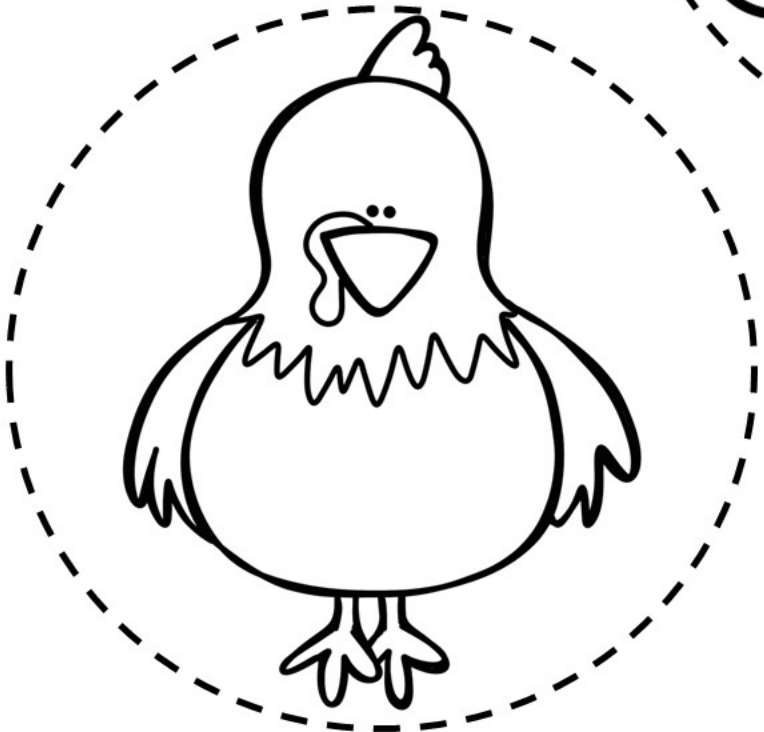
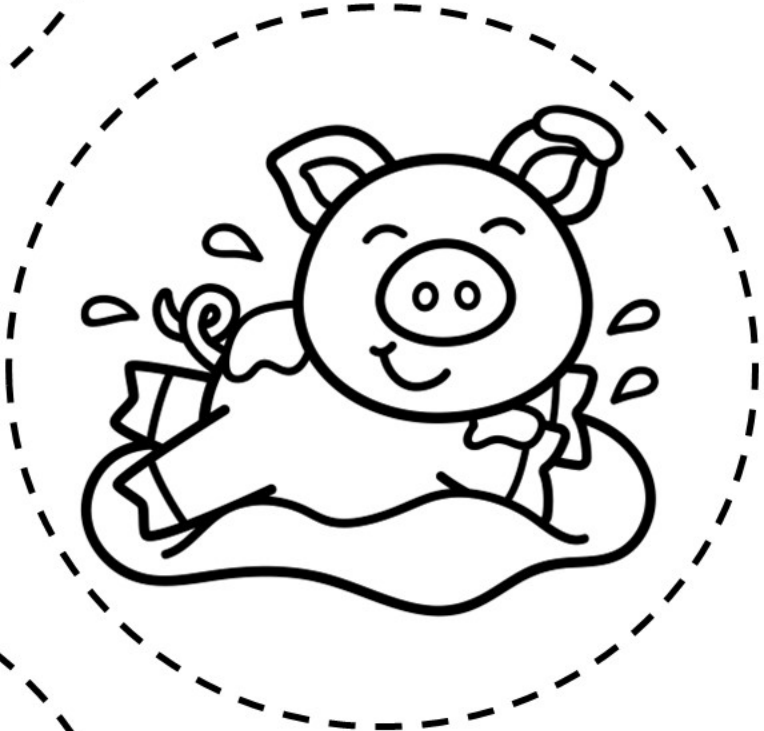
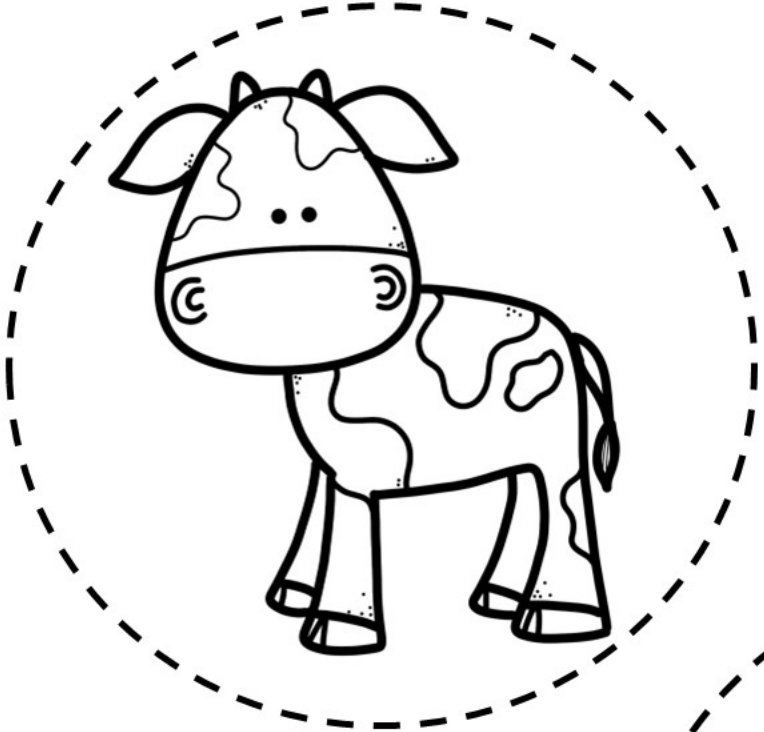

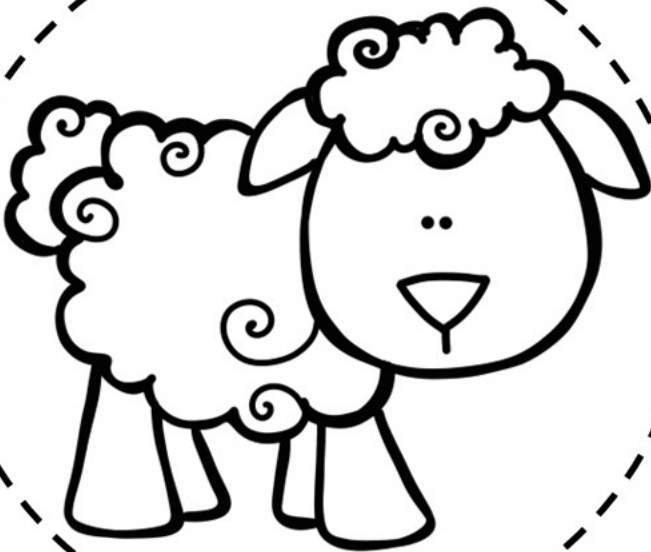
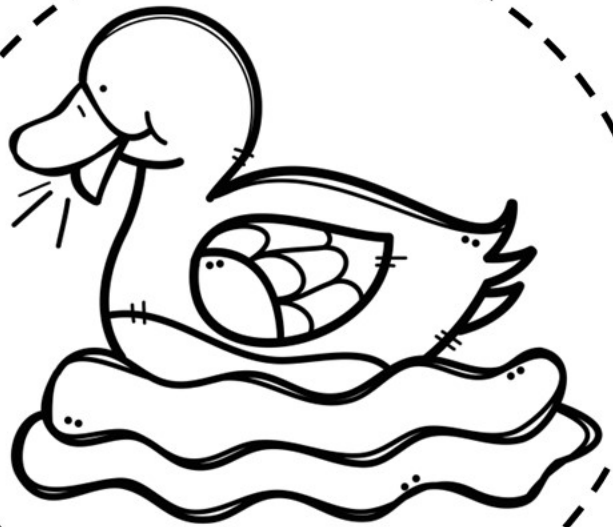
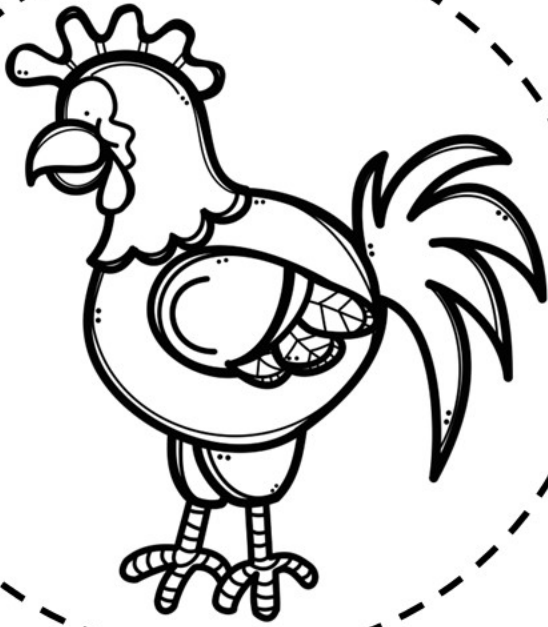

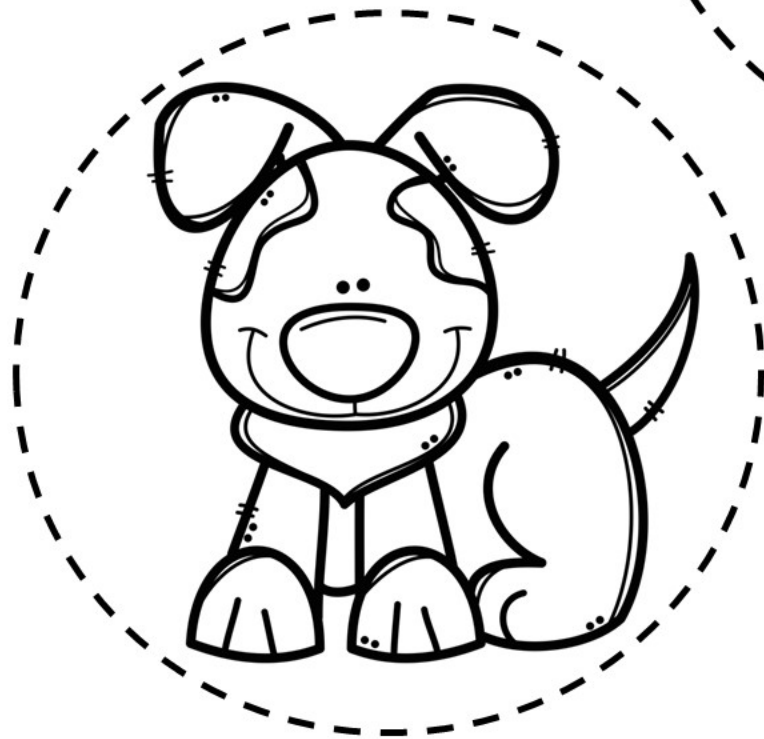
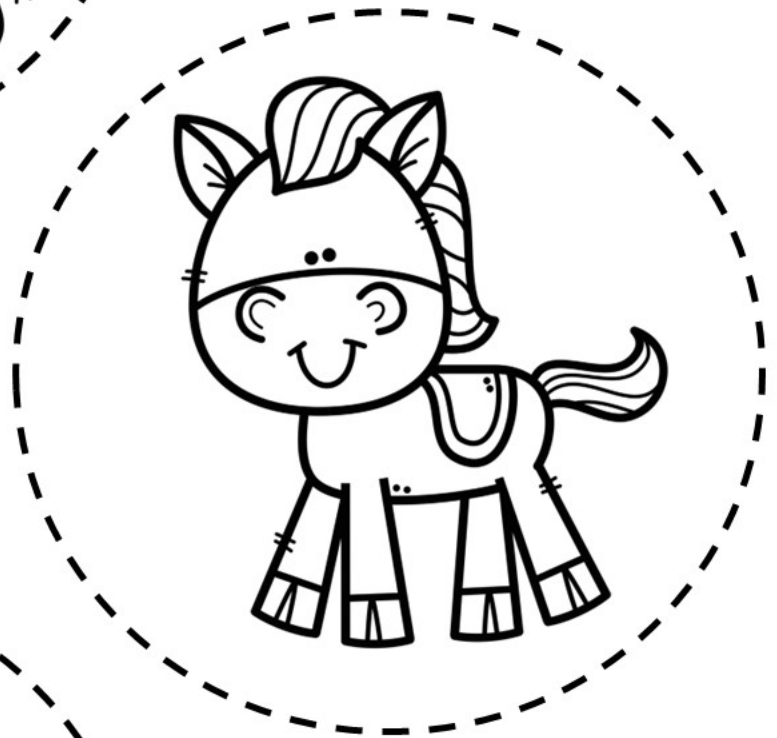
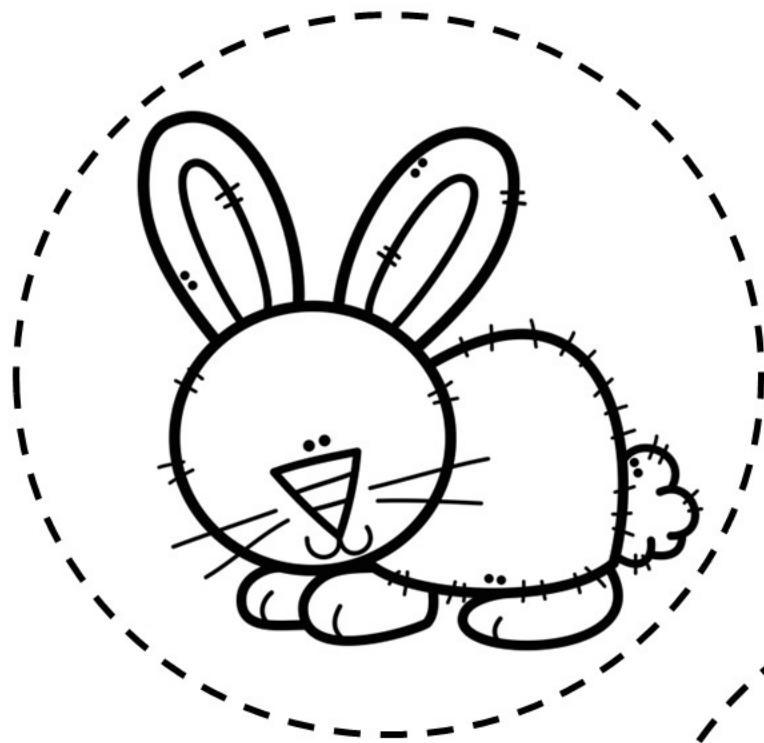

Down on the Farm

Growing up on a farm is a life a lot of children will never know or experience, but they can learn about farm life and appreciate all the hard work farmers do each day keep food on our table.

Living on a farm is A LOT of work but how awesome would it be to grow and raise everything you need to eat. A farmer is a person with a special job. They grow crops, fruits, vegetables, grains on the land and they raise animals too. Farmers take care of the animals every day. They water, feed and provide them with shelter. On the farm there are chores to be done everyday. There are different types of farms.

Some Types of Farmers

- Crop Farmers
- Livestock Farmers
- Ranchers
- Dairy Farmers
- Poultry Farmers
- Organic Farmers



Farmers

Crop Farmers: Crop farmers grow crops such as grains, fruits, vegetables and cotton. They are responsible for planting, irrigating, fertilizing, harvesting and storing their crops. Crop farmers may specialize in a specific type of crop.

Livestock Farmers: Livestock farmers raise animals such as cows, pigs, chickens, and sheep. They are responsible for providing food, water and shelter to their animals as well as monitoring their health and welfare.

Down on the Farm

Like Crop farmers they may specialize in a specific type of animal raising only cow,, or another animal.

Ranchers: Ranchers primarily raise livestock, often on a large, open ranch or pasture.

Dairy Farmers: Dairy farmers specialize in producing milk and other dairy products such as cheese, yogurt and ice cream. They are responsible for caring for their cows, milking them and processing the milk into dairy products.

Poultry Famers: Poultry famers specialize in raising chickens, turkeys, ducks or other birds for meat and eggs. They are responsible for providing food, water and shelter to their birds as well as monitoring their health and wellness.

Organic Famers: Organic farmers grow crops and raise animals using organic farmer practices.

What Jobs Do a Famer Do?

- Rake the dirt
- Plant seeds
- Feed the animals
- Water the plants
- Pick the fruit
- Pick the vegetables
- Collect the eggs

The workplace of a farmer is quite unique. You could say their office is the great outdoors.

They work outdoors and are in touch with nature on a daily basis.



Down on the Farm

Farmers typically start their days very early in the morning. They check on their livestock and crops to make sure everything is healthy and growing as it should. They feed and water their animals, they tend to equipment, such as tractors and plows to make sure they are in good working condition and ready for the day's work.

A farmer's day is long as they perform a variety of tasks that include planting and harvesting crops, mending fences, and caring for their animals.



A farmer's most important aspect of their workplace is the land.

Farmers have a deep appreciation for their environment and the role they play in caring for it. The land a farmer works each day is often passed down from generation to generation.

Being a farmer is a hard but rewarding job. Their days are long, and the work is hard.

We have so much to be thankful for when talking about farmers from clothes that we wear, the food that we eat and the milk that we drink.

Support Your Local



Farmer

Support Your Local

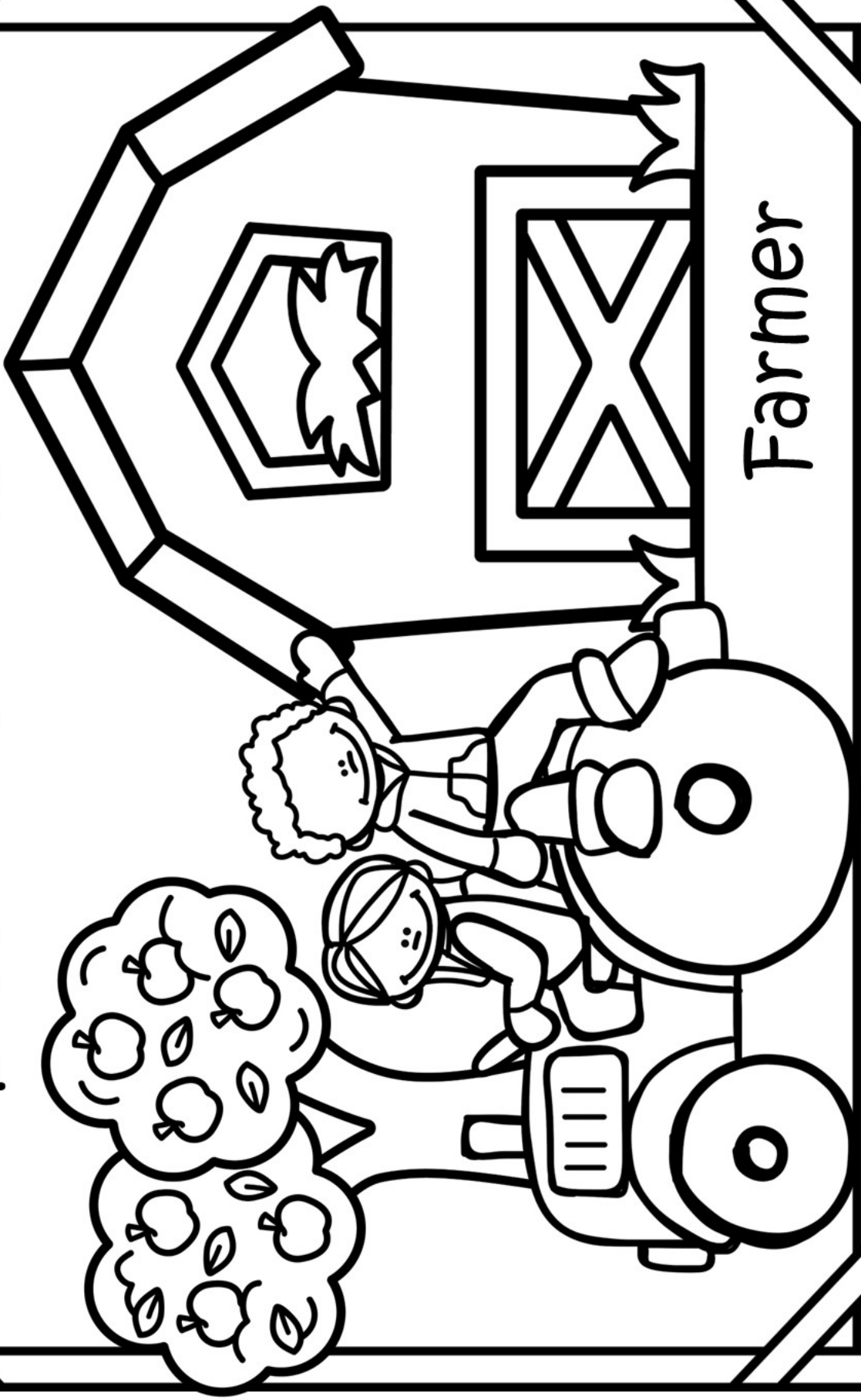

Farmer

Support Your Local



Farmer

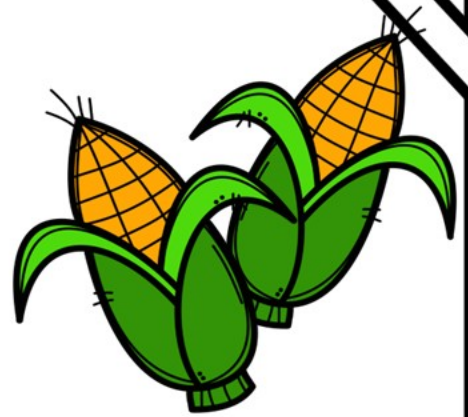

Farm Life

“Farming isn’t
just a job. It’s a
way of life.” –
Unknown

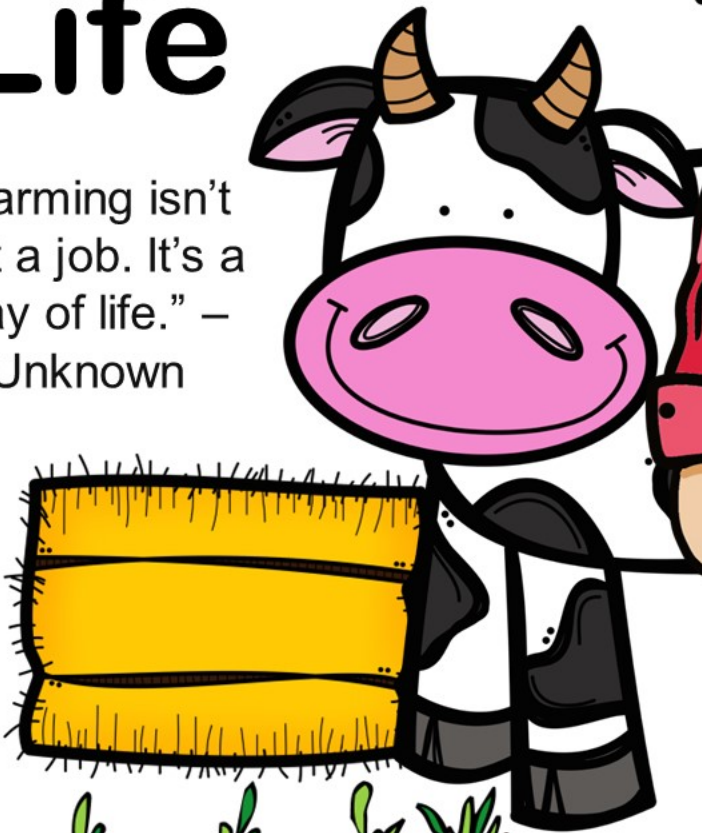

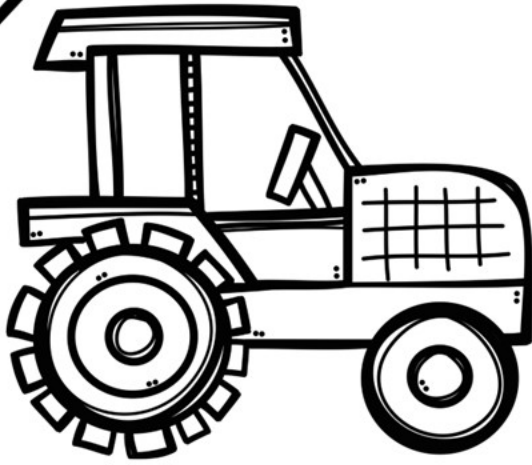

Farm Life

“Farming isn’t
just a job. It’s a
way of life.” –
Unknown

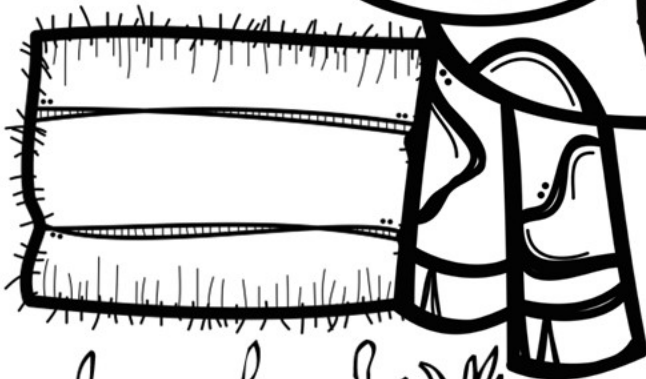



*"Farming isn't just a job.
It's a way of life." – Unknown*

Farm and Farm Animal Facts Posters in Color and B & W

What is a Farm?

A farm is a place where crops or animals are raised for food or other use. Most of the food we eat comes from farms.



Most animals raised on farms are called livestock. Cows, sheep, chicken and pigs.

Livestock provide foods such as meat, milk and eggs. They also give us wool and leather.

Plants raised on a farm are called crops. Some farmers grow food crops such as vegetables, grains and fruits.

Any vegetables, or fruits you eat were probably grown on a farm.

What is your favorite fruit or vegetable to eat?



What is a Farm?

A farm is a place where crops or animals are raised for food or other use. Most of the food we eat comes from farms.



Most animals raised on farms are called livestock. Cows, sheep, chicken and pigs.

Livestock provide foods such as meat, milk and eggs. They also give us wool and leather.

Plants raised on a farm are called crops. Some farmers grow food crops such as vegetables, grains and fruits.

Any vegetables, or fruits you eat were probably grown on a farm.

What is your favorite fruit or vegetable to eat?

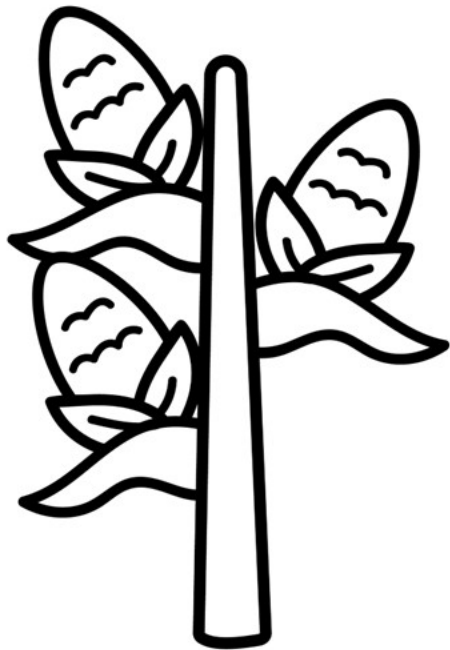

Farm Machinery and Tools

Farms use specific tools or equipment to do their job.

Tractor



Wheelbarrow



Stable

Scythe

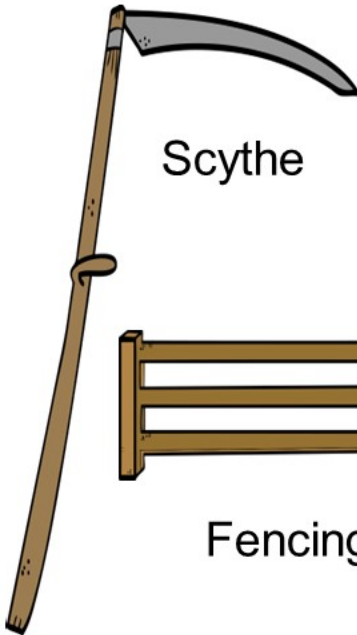

Farm Fork



Ax

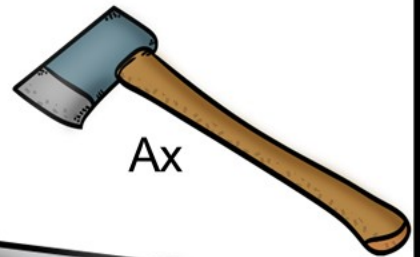

Fencing

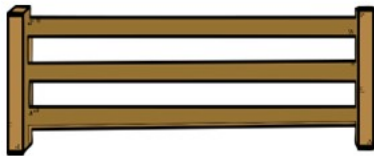

Barn



Spade Shovel



Boots



Hoe

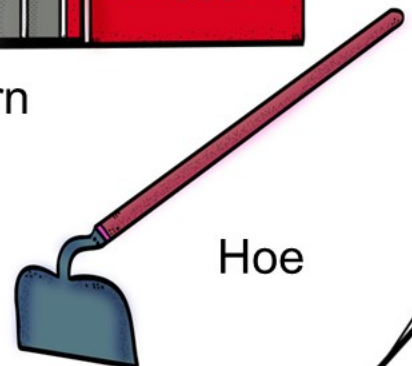

Farm Machinery and Tools

Farms use specific tools or equipment to do their job.

Tractor



Wheelbarrow

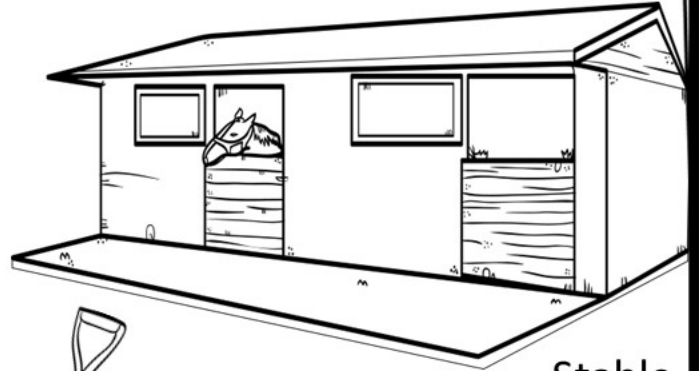

Stable

Scythe

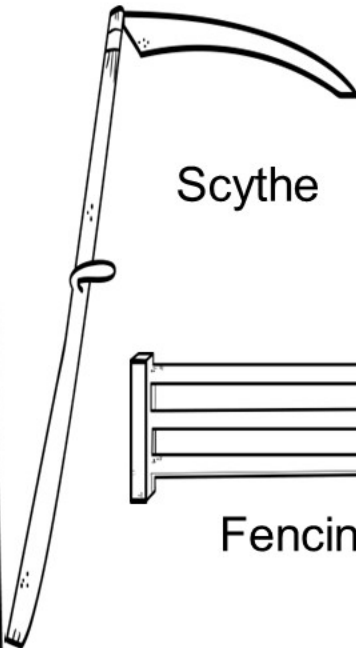

Farm Fork



Ax

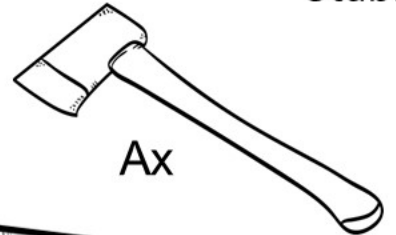

Fencing

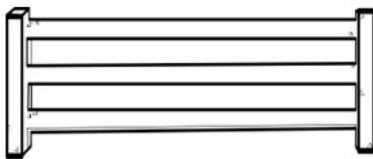

Barn



Spade Shovel



Boots

Hoe

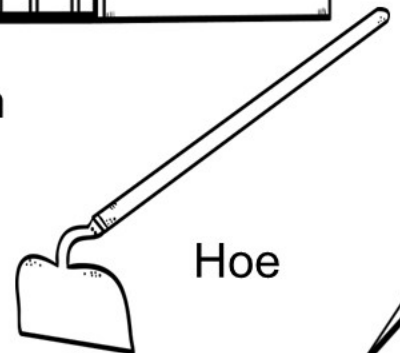

Each year, hundreds of thousands of trees are planted on farmland.

More than half of America's farmers intentionally provide habitat for wildlife.

Deer, moose, fowl, and other species have shown significant population increases for decades.

Tractors overtook horses and mules by 1954.

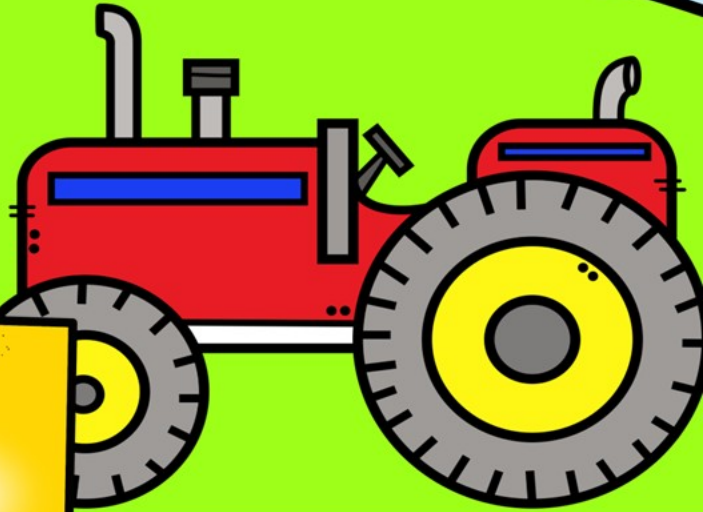

Texas has the most farms in the U.S.

FARM

Approximately 98% of dairy farms in the U.S. are owned and operated by families.

FACTS

The most important crop to the United States is corn.

Farming provides millions of American jobs.

The average U.S. farmer feeds 155 people annually in the U.S. and abroad.

About 60% of harvested corn is fed to livestock, and 25% is exported.



Around 80 million acres of corn are planted in the U.S. each year.



Each year, hundreds of thousands of trees are planted on farmland.

More than half of America's farmers intentionally provide habitat for wildlife.

Deer, moose, fowl, and other species have shown significant population increases for decades.

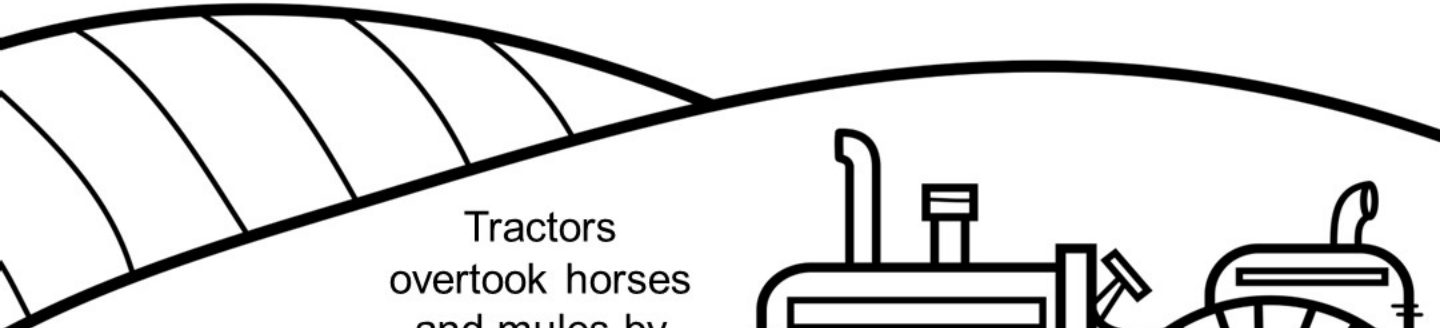

Tractors overtook horses and mules by 1954.

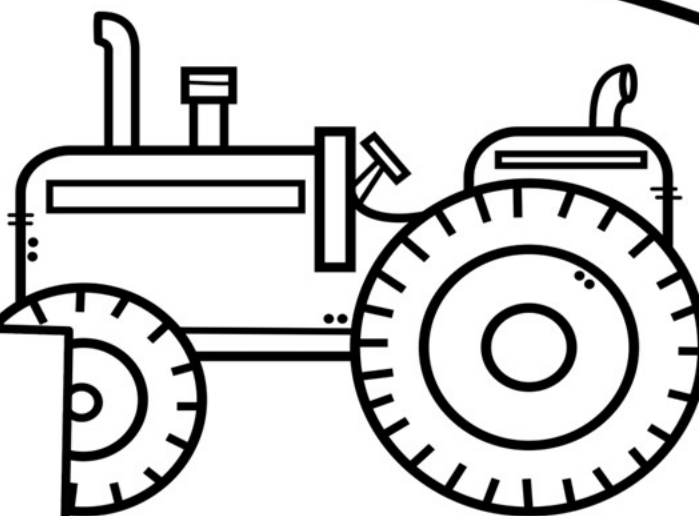

Texas has the most farms in the U.S.

Approximately 98% of dairy farms in the U.S. are owned and operated by families.

FARM FACTS

The most important crop to the United States is corn.

Farming provides millions of American jobs.

The average U.S. farmer feeds 155 people annually in the U.S. and abroad.

About 60% of harvested corn is fed to livestock, and 25% is exported.



Around 80 million acres of corn are planted in the U.S. each year.

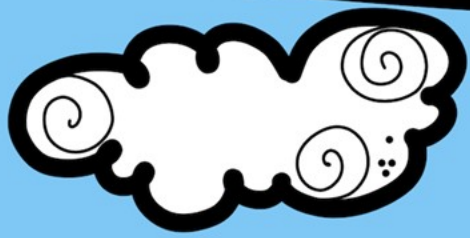

Sheep grow two teeth a year until they have eight.



Sheep are social animals

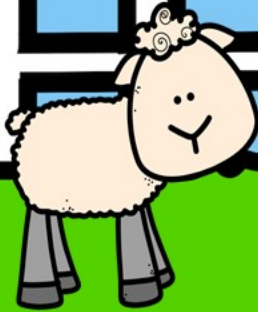
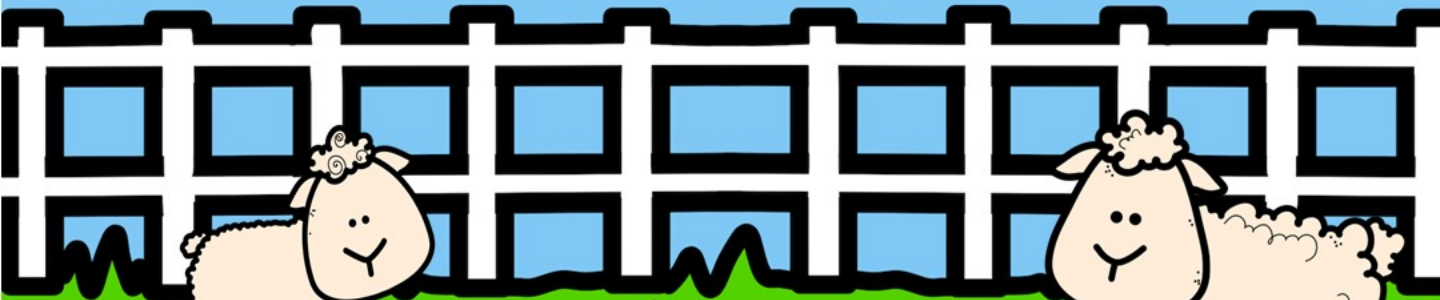

Adult female sheep are known as ewes.



SHEEP

A sheep can produce between 2 – 30 pounds of wool each year.

Sheep have 4 stomach compartments.

FACTS

Adult male sheep are known as rams.

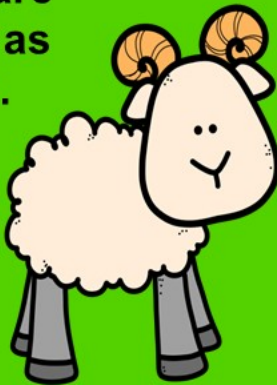

1 pound of wool can make up to 10 miles of yarn.

Sheep produce wool and milk.

Sheep can remember at least 50 individual sheep and humans for years, and display emotions by their ear position.



Sheep grow two teeth a year until they have eight.



Sheep are social animals

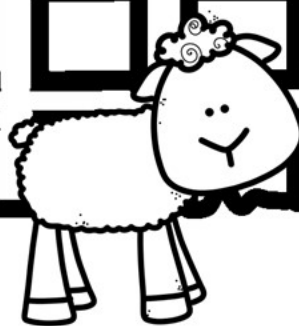
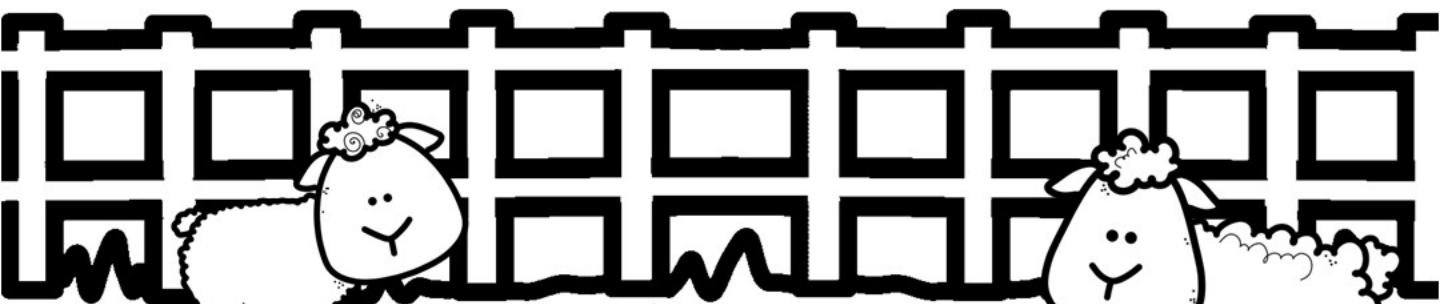

Adult female sheep are known as ewes.



SHEEP

A sheep can produce between 2 – 30 pounds of wool each year.

Sheep have 4 stomach compartments.

FACTS

Adult male sheep are known as rams.



1 pound of wool can make up to 10 miles of yarn.

Sheep produce wool and milk.

Sheep can remember at least 50 individual sheep and humans for years, and display emotions by their ear position.



There are over 1000 different breeds of cattle in the world, and over 1.4 billion cattle in total.



Cows are smart and intelligent animals.



Cows can live up to 25 years.



The average cow can produce 46,000 glasses of milk a year.

COW

Cows consume an average 3 to 30 gallons of water per day.

FACTS



Baby cows are called calves, adult females are called cows, and adult males are called bulls.

Cows can run 35 miles per hour, and even faster in deep mud.

Cows like to eat plants and grass and are colorblind to red and green colors.



There are over 1000 different breeds of cattle in the world, and over 1.4 billion cattle in total.



Cows are smart and intelligent animals.

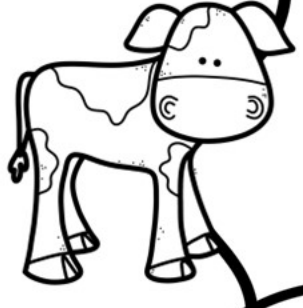

Cows can live up to 25 years.



The average cow can produce 46,000 glasses of milk a year.

COW

FACTS

Cows consume an average 3 to 30 gallons of water per day.

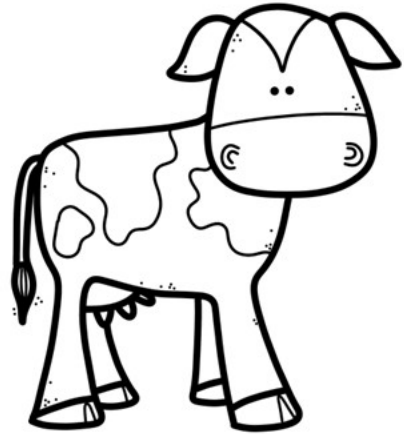

Baby cows are called calves, adult females are called cows, and adult males are called bulls.

Cows can run 35 miles per hour, and even faster in deep mud.

Cows like to eat plants and grass and are colorblind to red and green colors.

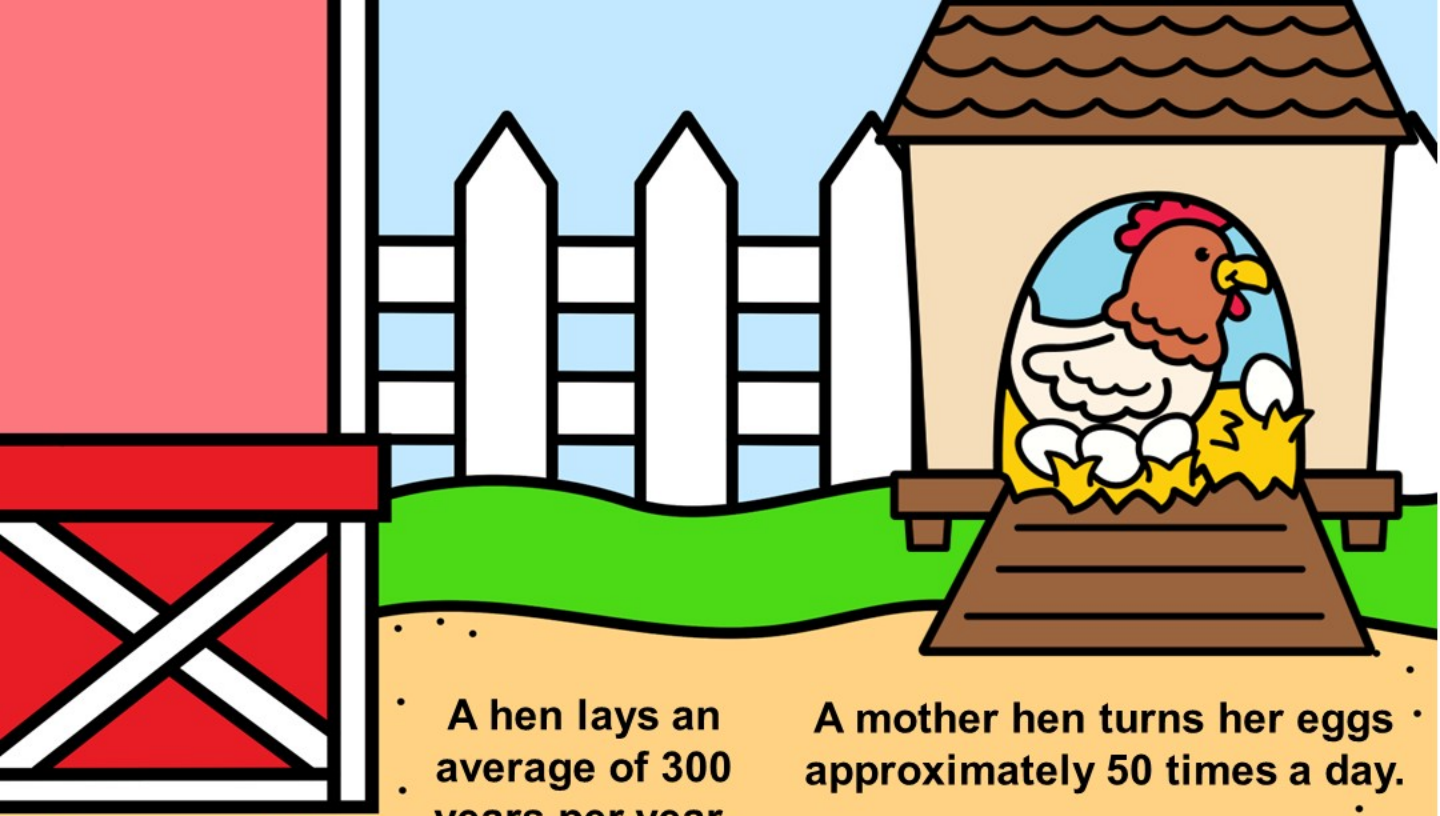

A hen lays an average of 300 eggs per year.

A mother hen turns her eggs approximately 50 times a day.

A chicken takes 21 days to hatch.



Chicken

A chicken's life span is about 10 – 15 years.

The longest recorded flight of a chicken is 13 seconds.



FACTS

Chickens swallow gravel to help mash food.

Chickens cluck after they lay an egg.

A chicken can travel up to 9 miles per hour.

There are approximately 175 varieties of chickens.

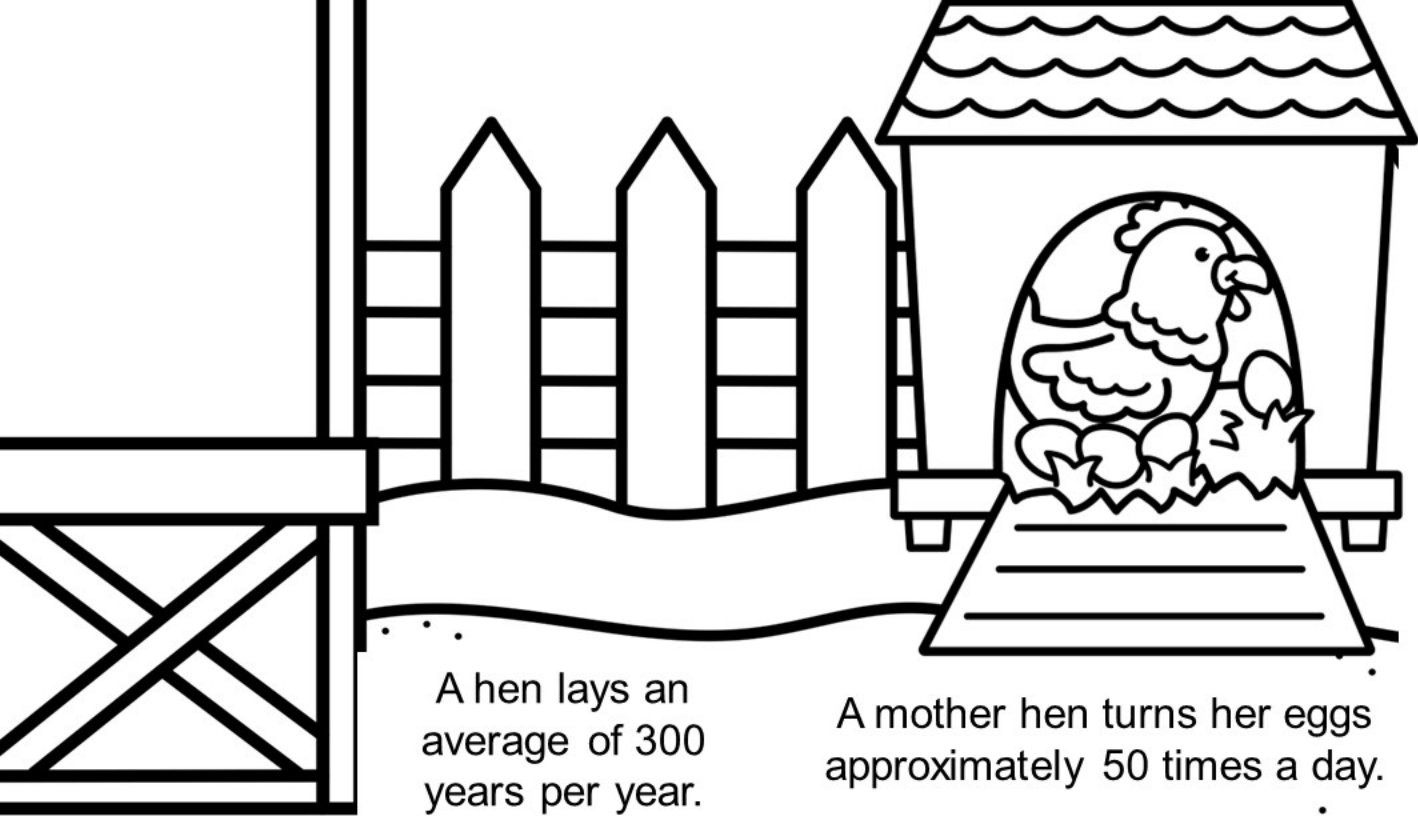

A hen lays an average of 300 years per year.

A mother hen turns her eggs approximately 50 times a day.

Chicken

A chicken takes 21 days to hatch.



A chickens life span is about 10 – 15 years.

FACTS

The longest recorded flight of a chicken is 13 seconds.

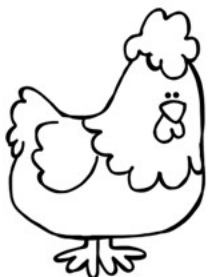

Chicken swallow gravel to help mash food.

Chicken cluck after they lay an egg.

A chicken can travel up to 9 miles per hour.

There are approximately 175 varieties of chickens.

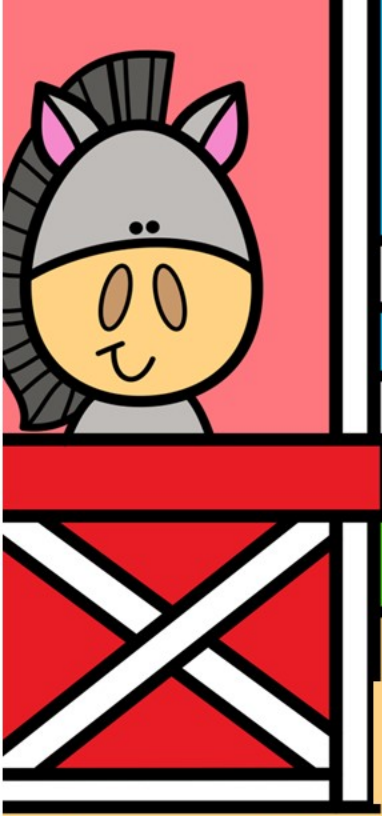

A young female horse is called a filly.

A male horse is called a stallion.



A horse lives about 25 years.

A young male horse is called a colt.

horse

The average horse weights 1200 lbs.

FACTS

There are over 300 breeds of horses around the world.

Horses can't breathe through their mouth.

A female horse is called a mare.



A horses teeth grow continually throughout his life.

Horses can sleep standing up by locking their leg joints.

Horses have 10 different muscles in their ears.



A young female horse is called a filly.

A male horse is called a stallion.

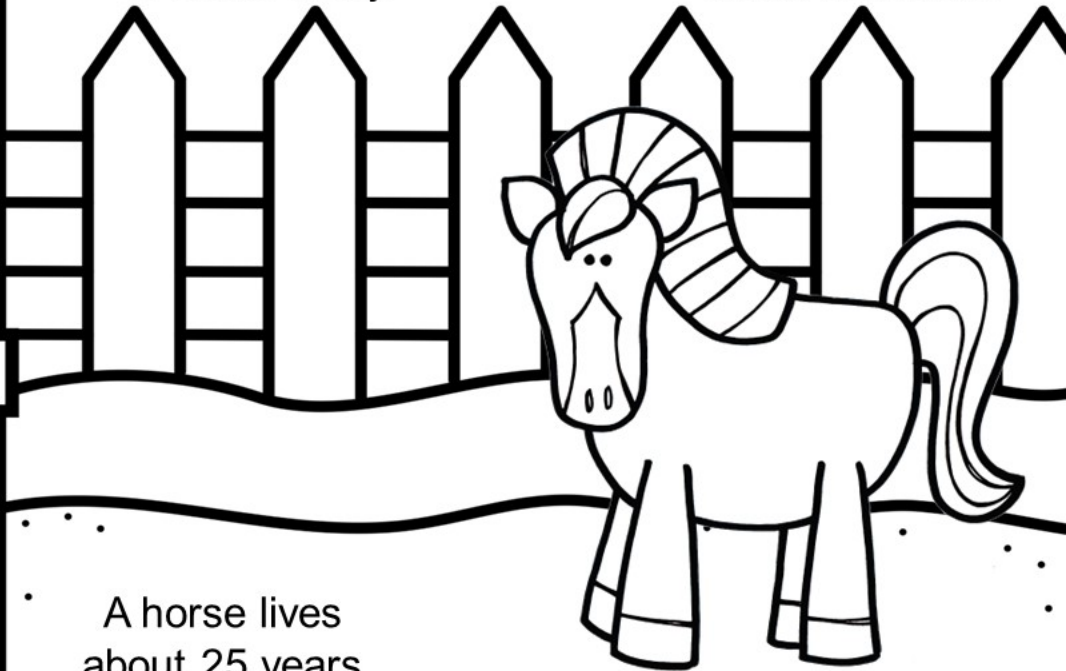

A horse lives about 25 years.

horse

A young male horse is called a colt.

The average horse weights 1200 lbs.

There are over 300 breeds of horses around the world.

FACTS

Horses can't breathe through their mouth.

A female horse is called a mare.

A horses teeth grow continually throughout his life.

Horses can sleep standing up by locking their leg joints.

Horses have 10 different muscles in their ears.



There are around 675 million pigs in the world.

Pigs spend 1/3 of their day sleeping.



Pigs have complex social lives and like to be around each other.



Pigs wallow in mud or water to cool down.

Pigs are the smartest animals in the world, ranking just after apes and dolphins.



Pig

FACTS

Pigs are very clean and organized.

An adult pig has 44 teeth.

Pigs can live between 9 – 15 years.

Pigs don't sweat much.

A full-grown pig can drink up to 14 gallons of water.

Some pigs have straight tails, while other pigs have curly tails.

Pigs are fantastic swimmers.

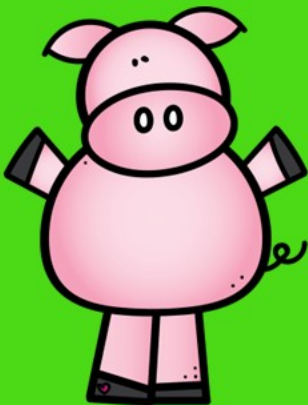

There are around 675 million pigs in the world.

Pigs spend 1/3 of their day sleeping.



Pigs have complex social lives and like to be around each other.

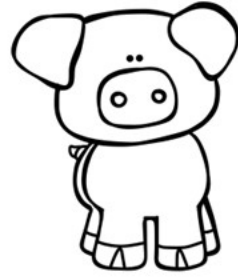

Pigs wallow in mud or water to cool down.

Pig

Pigs are the smartest animals in the world, ranking just after apes and dolphins.



Pigs are very clean and organized.

FACTS

An adult pig has 44 teeth.

Pigs can live between 9 – 15 years.

Pigs don't sweat much.

A full-grown pig can drink up to 14 gallons of water.

Some pigs have straight tails, while other pigs have curly tails.

Pigs are fantastic swimmers.

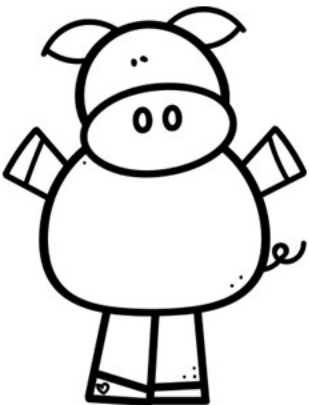

Down on the Farm

Monday
Circle Time

Fun Farm Animal Facts

- Most kids know that pigs like to roll around in mud, but they may not know pigs do this to cool off because they don't sweat. Despite being stereotyped as dirty, pigs are actually, rather clean.
- According to many historians, goats were the first animal to be domesticated. Goats are typically the cleanest of animals. They are much more select feeders than cows, chickens, or even dogs. They typically will not eat food that has been contaminated or that has been on the floor or ground.
- While pigs prefer to spend the majority of their day at rest, they are capable of running roughly 11 miles per hour.
- Pigs communicate with each other using more than 20 different noises.
- Every cow's pattern of spots is different.
- A male cow's horns feature rings, the number of which roughly equals its age.
- With a sense of smell so strong, cows are able to detect scents up to five or six miles away.
- Like many domesticated pets, cows learn and react to the names they are given by people.

Down on the Farm

Monday
Circle Time



Fun Farm Animal Facts

- Most kids know that pigs like to roll around in mud, but they may not know pigs do this to cool off because they don't sweat. Despite being stereotyped as dirty, pigs are actually, rather clean.
- According to many historians, goats were the first animal to be domesticated. Goats are typically the cleanest of animals. They are much more select feeders than cows, chickens, or even dogs. They typically will not eat food that has been contaminated or that has been on the floor or ground.
- While pigs prefer to spend the majority of their day at rest, they are capable of running roughly 11 miles per hour.
- Pigs communicate with each other using more than 20 different noises.
- Every cow's pattern of spots is different.
- A male cow's horns feature rings, the number of which roughly equals its age.
- With a sense of smell so strong, cows are able to detect scents up to five or six miles away.
- Like many domesticated pets, cows learn and react to the names they are given by people.

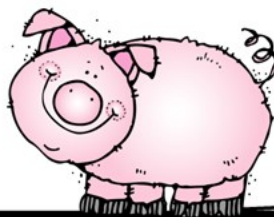

Down on the Farm

Monday
Circle Time

Fun Farm Animal Facts

- Although one sheep may look like any other to a person, members of the same flock have been known to recognize one another even after years of separation.
- A flock is a social group and a defense mechanism, facing threats together.
- When a sheep's fleece is shaved, it must be done in one piece, with the person doing it also holding the sheep still.
- Female goats have beards, just like the males.
- Some are born with horns and, much like human fingernails which are made of the same material, the horns continue to grow for the goat's entire life.
- Goats are not only skilled swimmers; they can also climb trees and traverse a ledge as deftly as a circus high-wire performer.
- "Cock-a-doodle-do" is often one of the first sounds that toddlers learn.
- The rooster's crow that signals the sunrise may be heard before any light is seen as chickens spot the break of light almost an hour before people do.
- Chickens wash with dust rather than water and clean feathers with their beaks.

Down on the Farm

Monday
Circle Time

Fun Farm Facts

- There are around 2.2 million farms in the United States.
- Americans spend 10% of their income on food, which is the lowest of any country.
- Approximately 97% of U.S. farms are operated by families, family partnerships, or family corporations.
- Farm and ranch families comprise just 2% of the U.S. population.
- One in three farm acres is planted for export.
- Farming employs more than 24 million American workers.
- More than 100 agricultural crops in the U.S. are pollinated by bees. In fact, one out of three bites of food people eat is thanks to honeybees.
- Bees contribute to more than \$15 billion worth of crops every year through pollination.
- Livestock farming feeds billions of people and employs 1.3 billion people. That means about 1 in 5 people on Earth work in some aspect of the livestock farming.



Down on the Farm

Monday
Circle Time

Fun Farm Facts

- The most important crop to the United States is corn.
- Corn is planted in the springtime and harvested in the fall every year.
- Corn is primarily consumed by humans, but it's also a great food for cattle.
- Humans usually eat sweet corn and popcorn.
- Farms produce all kinds of plants, animals, wool and cotton that people eat and utilize throughout the world.
- Farming is an important occupation, because everyone needs food and clothing to survive.
- Farmers work long, hard hours to give us the food that we eat.



Horse



Blank rectangular box for writing.

Blank rectangular box for writing.

Blank rectangular box for writing.

Cow



Blank rectangular box for writing.

Blank rectangular box for writing.

Pig

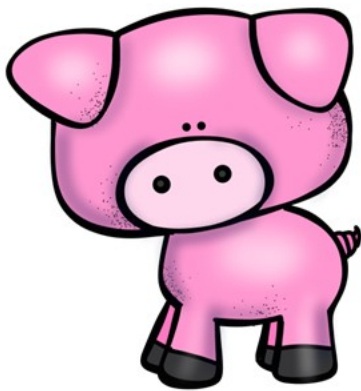

Blank rectangular box for writing.

Sheep





My Favorite

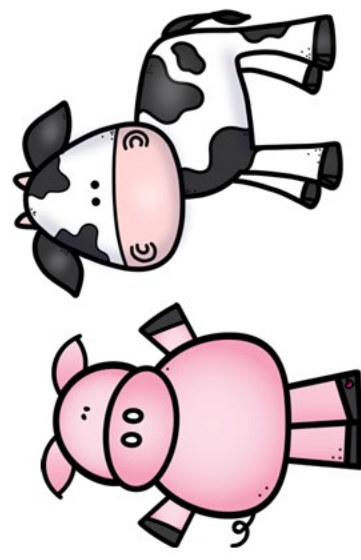

Farm Animal!



Favorite Farm Animal

What is the classes favorite farm animal?



Child's Name	Cow	Pig	Horse	Sheep

Farm Counting Poem

One, two,
Cows moo.
Three, four,
Sheep snore.
Five, six,
Pig tricks.
Seven, eight,
Horse gate.
Nine, ten,
A big fat hen.

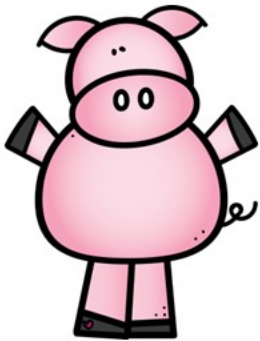

Words of the Week – Y

Print up the following sheets onto white card stock. Cut out and laminate.

Use these pictures during circle time if children are having a hard time producing Y words.

Use the dry eraser board for additional words they produce.

Note: After laminating pictures, use Velcro dots on back to hang from flannel. Rough side of Velcro.

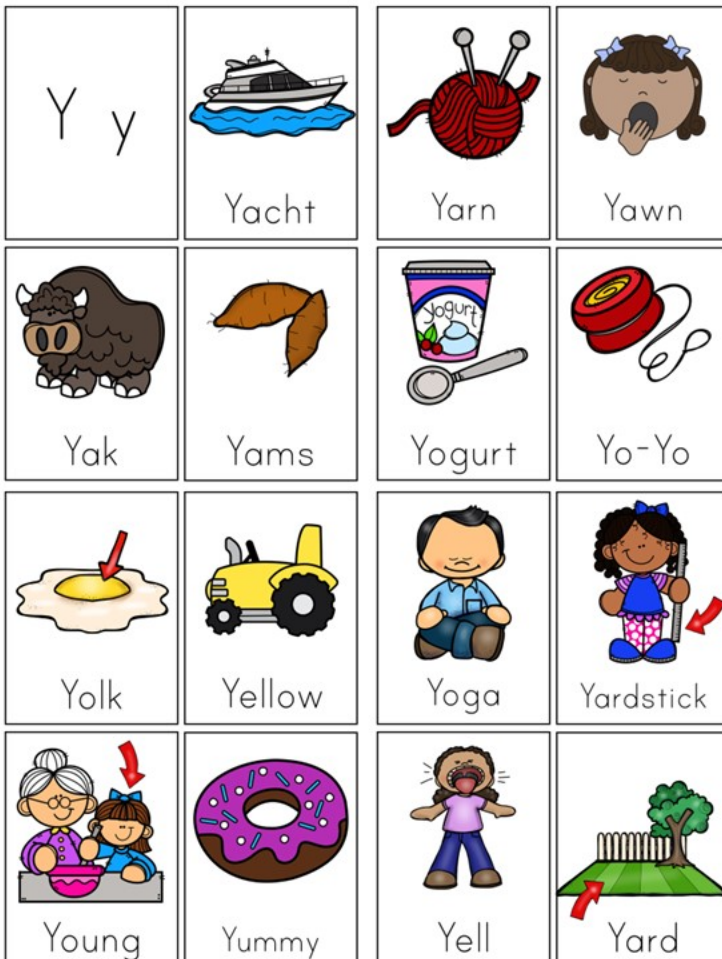

Words that begin with Y

Yacht
Yarn
Yawn
Yak
Yams
Yogurt
Yo-Yo
Yolk
Yellow
Yoga
Yardstick
Young
Yummy
Yell
Yard

ECIPs

Domain: Approaches to Learning

Component: AL10-13 Processing and Utilizing Information

Subcomponent AL11 Symbolic Representation Child uses sounds, actions, objects and materials (paint, clay, blocks, etc.) to express their ideas and understanding as well as to make new connections

AL11.6 Notices written words represent objects, people or events and begins to use in play

AL11.8 Begins to use print as a tool to express thoughts, ideas and to intentionally communicate

Domain: Language, Literacy and Communications

Component: LLC 5-13 Emergent Reading

Subcomponent L4 Motivation, engagement: Child has an interest in and sustained attention for literacy acts

L4.7 Shows interest in both pictures and text

L4.12 Actively participates in reading activities with enjoyment and purpose

K 0.1.10.10 Actively participates in group reading activities with purpose and understanding including the appropriate selection of text for personal enjoyment, interest and academic tasks

Y y



Yacht



Yak

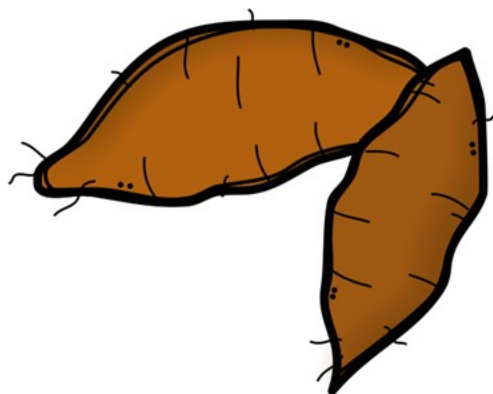

Yams

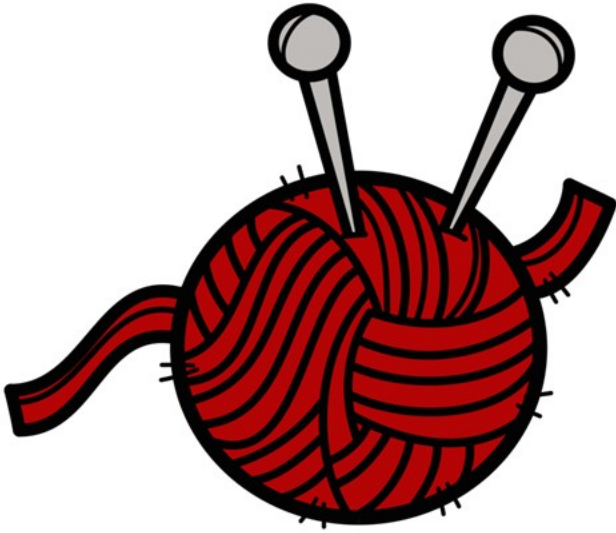

Yarn



Yawn



Yogurt



Yo-Yo

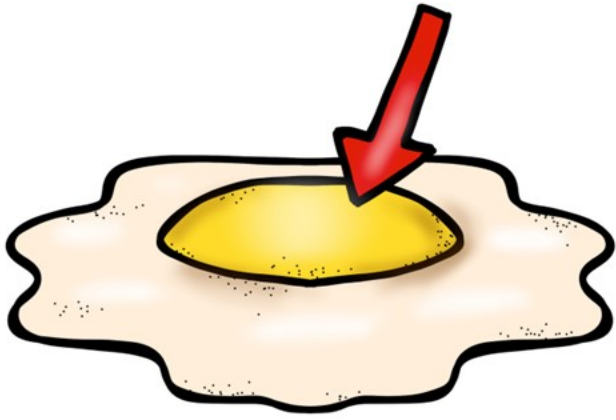

Yolk

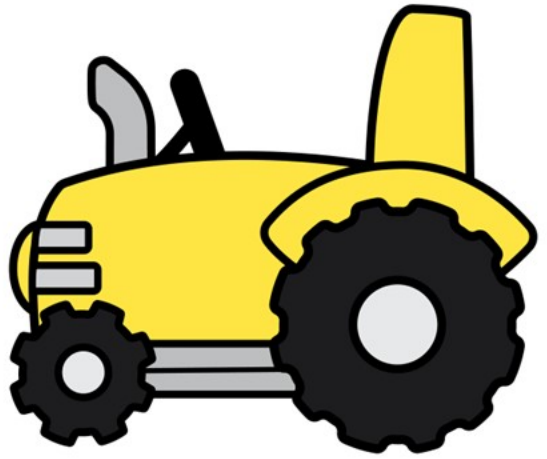

Yellow



Young

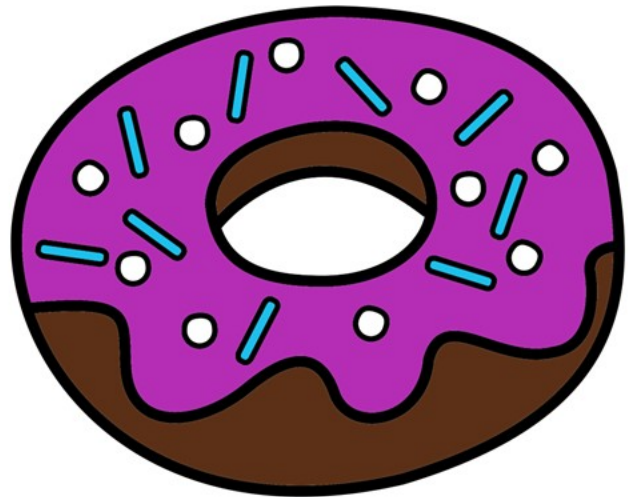

Yummy



Yoga



Yardstick



Yell

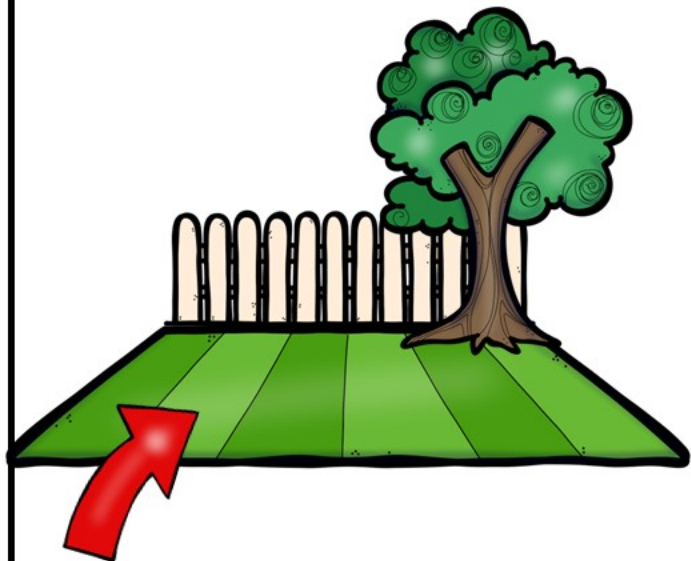

Yard

Cow or Pig Activity

ECIPs

Domain: Mathematics

Component: M1-6: Number Knowledge

Subcomponent M1 Rote counting The child attends to sequences and use of number words, with or without items, sets, or numerals and without recognizing the link to quality

M1.8 Shows interest in counting or number-oriented play, and notices numbers in the environment during free play

M1.12 Points to objects while reciting number word sequence

Sheets 5 and 6 are the cow and pig cards. After coloring the square on the graph sheet, have a child place either a cow or pig card in the pocket chart.

Print up spinner
and trim.
Attach spinner.

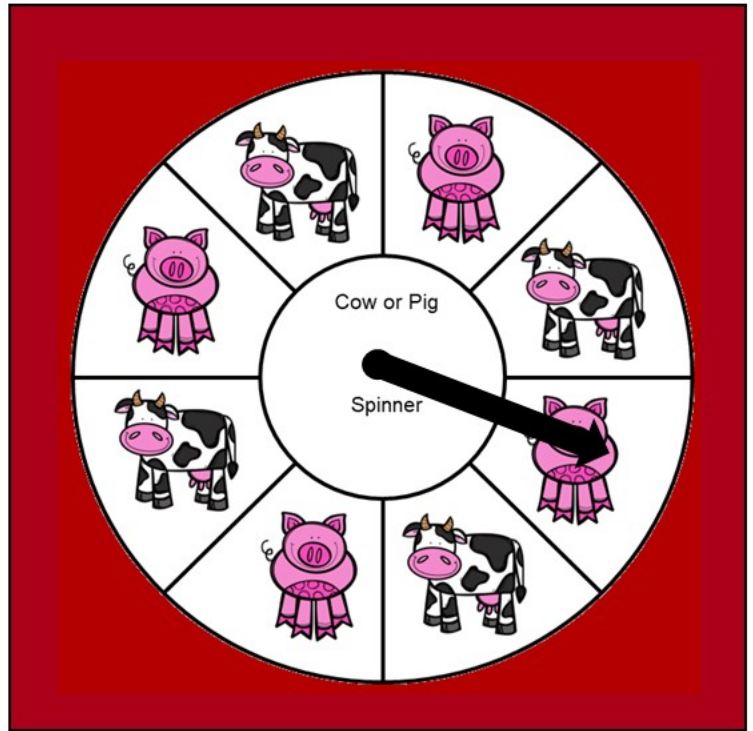

Notes: Pocket chart purchased at Lakeshore Learning
www.lakeshorelearning.com/

- Magnet Small Pocket Chart
- 26" x 27" nylon pocket chart
- Hangs with magnetic strips or grommets
- 6 rows of clear view pockets

Arrow spinners can be purchased at
http://www.boardgamedesign.com/pages/go_shopping/arrows.htm



123 Learn Curriculum



Cows
Pigs

or
Graph



Cow or Pig Graphing

What will come up more often on the spinner – Cow or Pig?





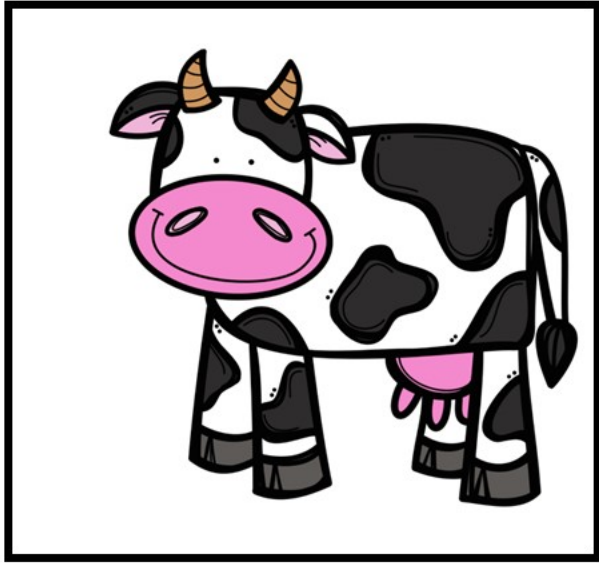
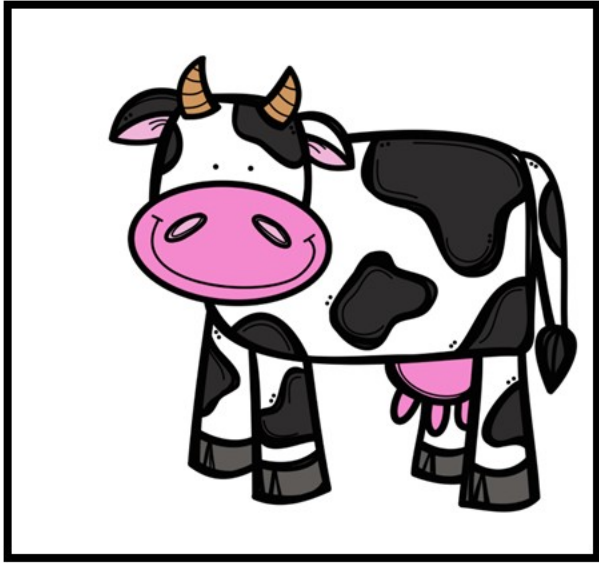
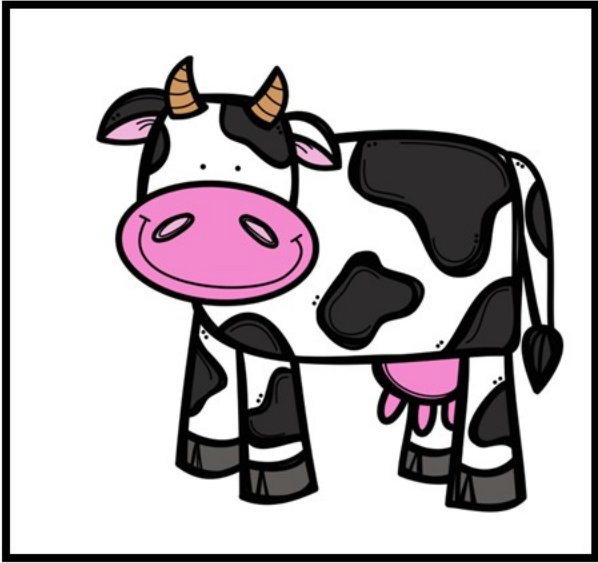
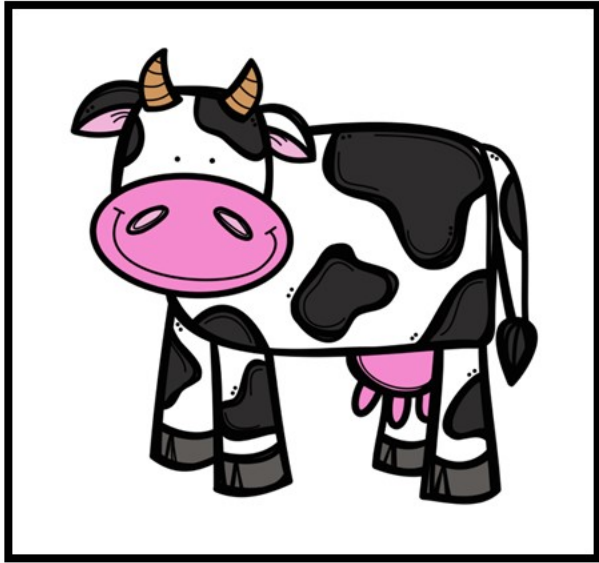
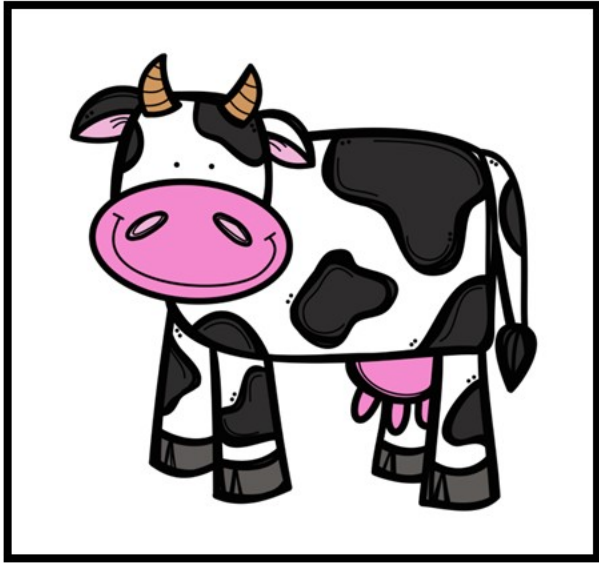
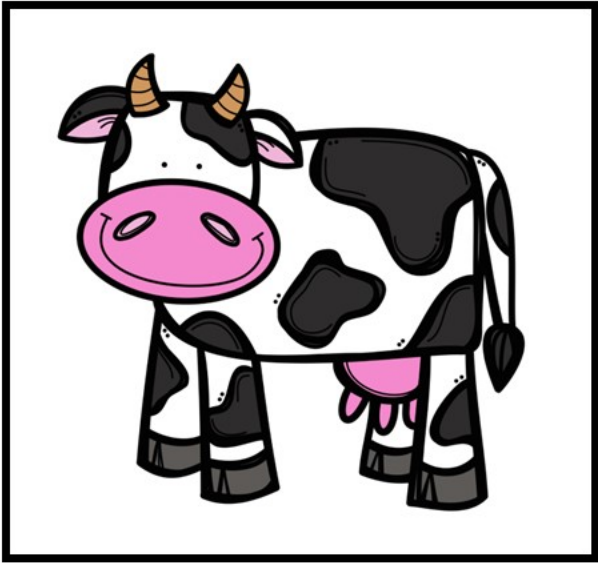

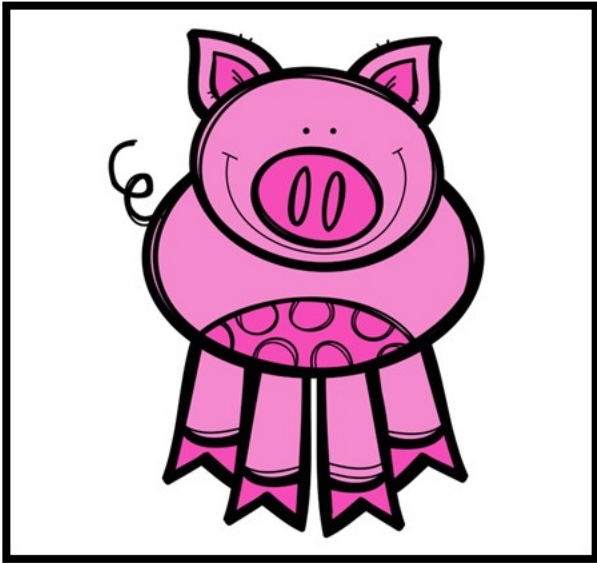
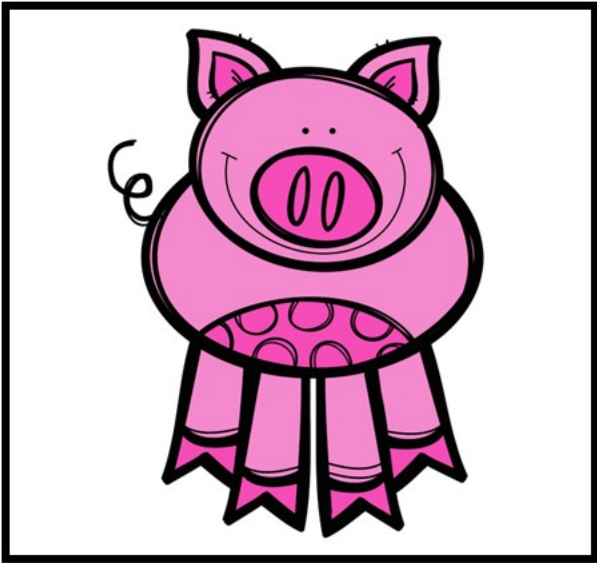
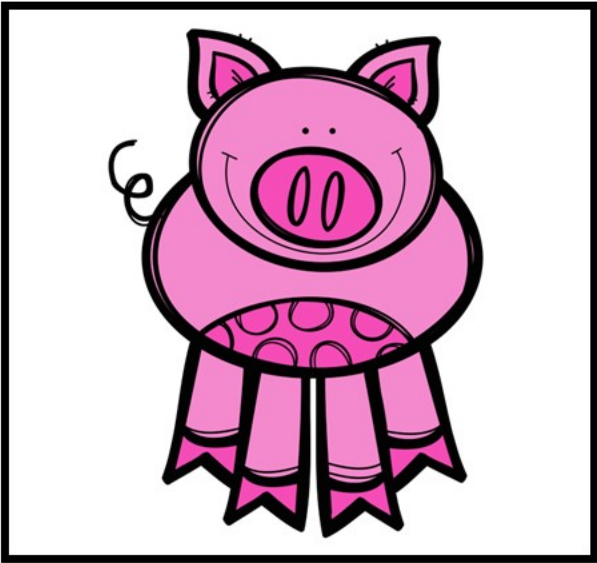
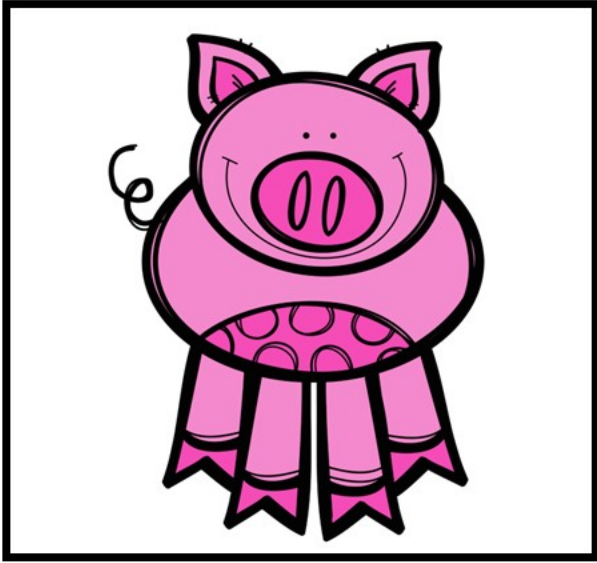
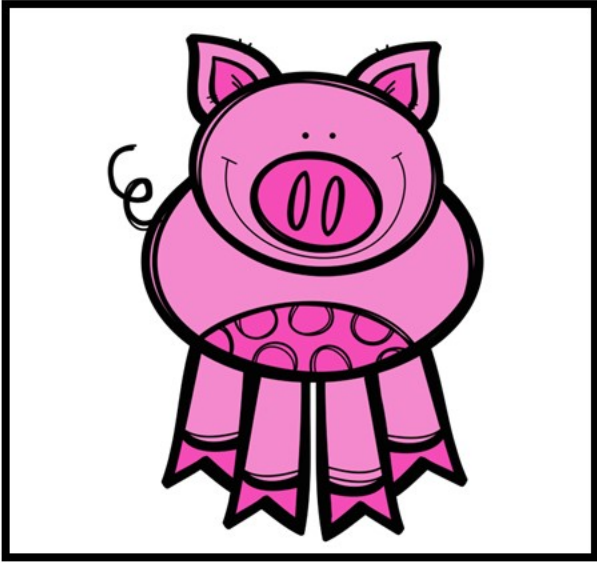
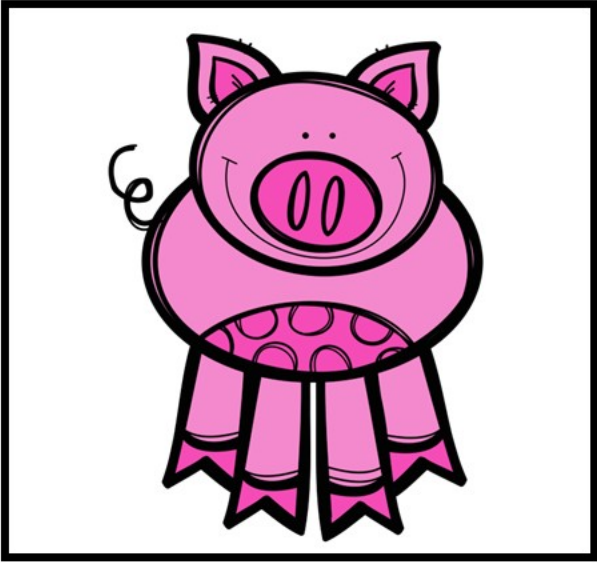

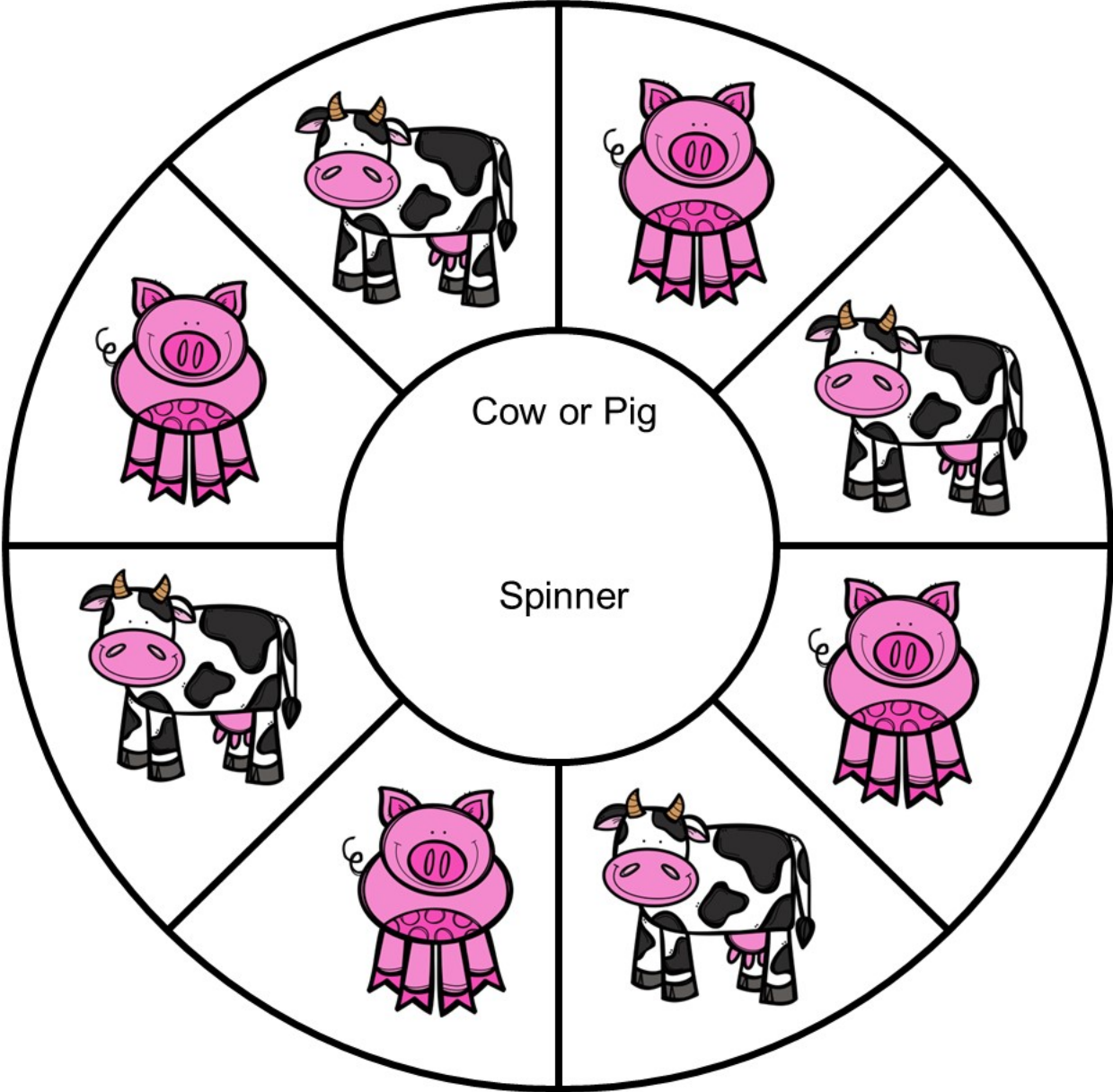

Cow or Pig

Spinner

Sample of interactive writing – Down on the Farm

The following sheets can be used if you want to print up and tape to a large piece of paper for your interactive writing. They include farm animals and farm item pictures in both color or b & w.

ECIPs

Domain: Language, Literacy and Communication

Component L9: Writing

Subcomponent: L9 Writing Conventions: Child understands the forms and function of written language

L9.7 Demonstrates interest to writing as a way of communicating

Down on the Farm

Interactive Writing

Circle Time

Alternate Interactive Writing Idea: Using large easel paper, pre-write farm words with a picture but leave the beginning letter out. Go over the words with the children and looking at the picture, ask them what the word is. Have them sound out the word and listen for the beginning letter sound. Have one of the children come up and write the missing letter.

o ____ow 

 ____ig

o ____orse 

 ____arn

o ____orn 

Down on the Farm Pictures for
Interactive Writing
Color and B & W

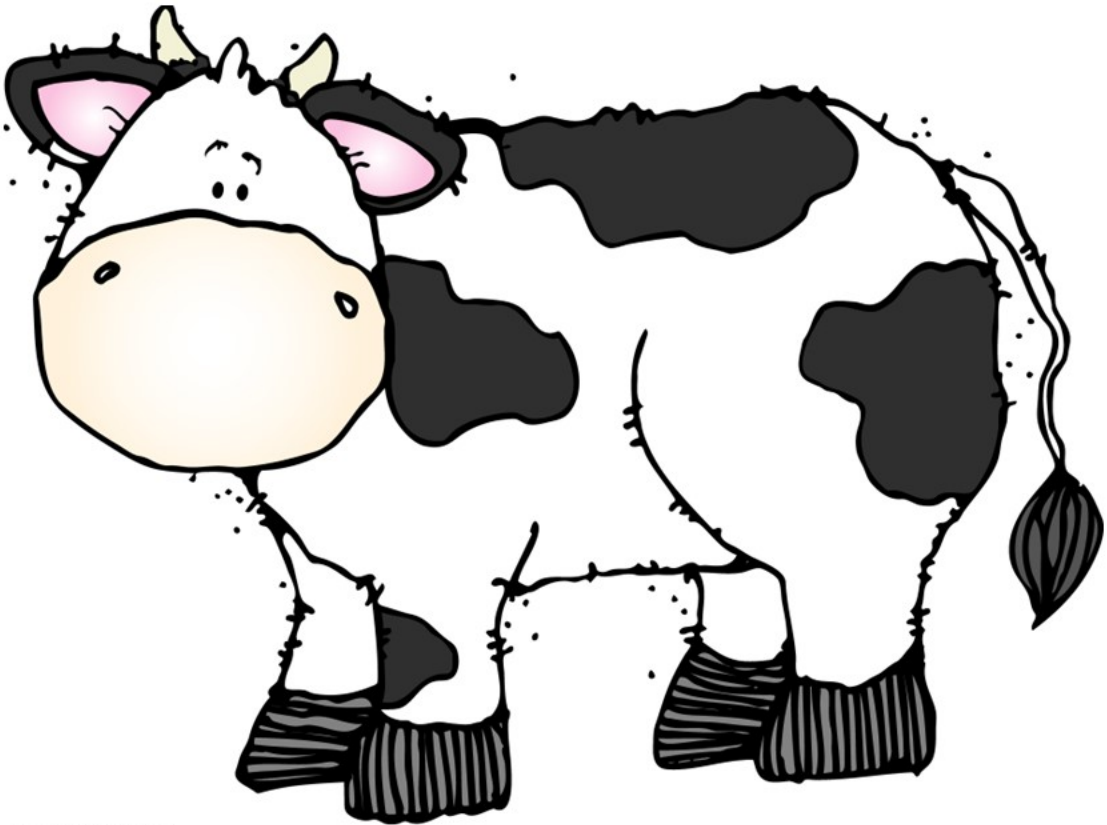
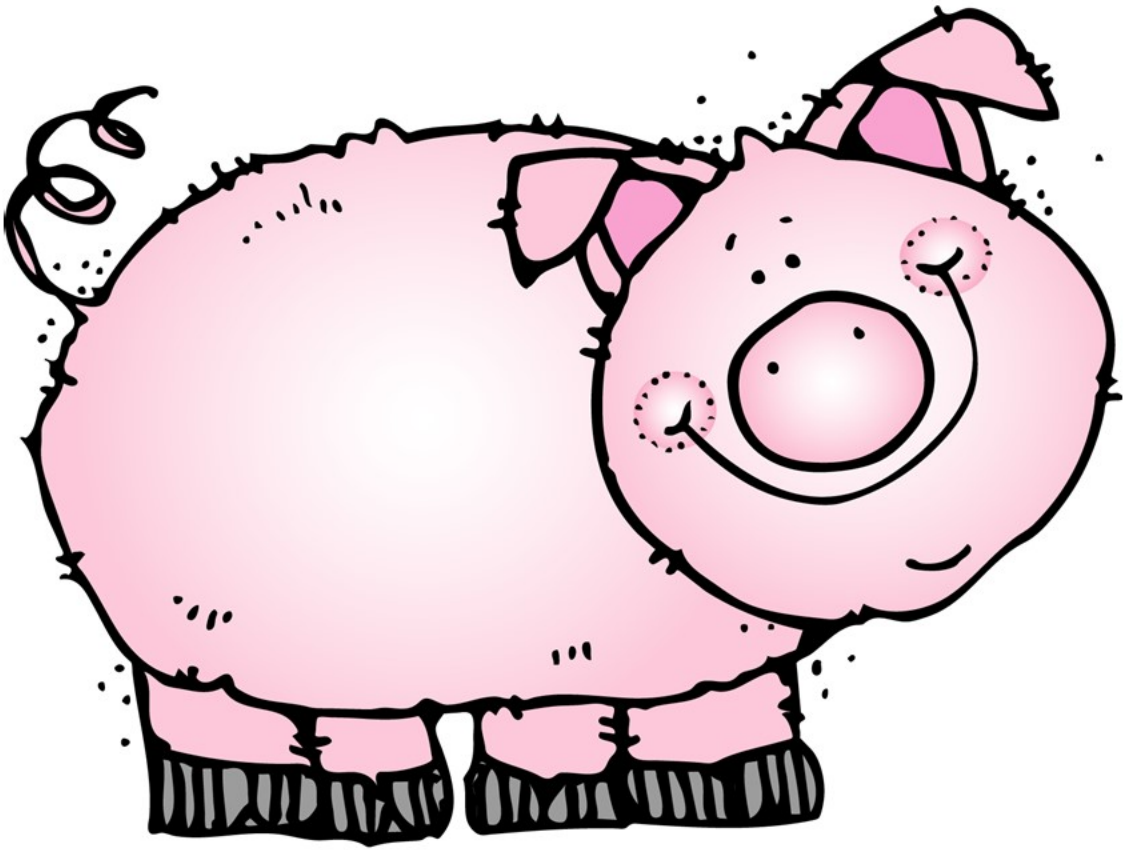

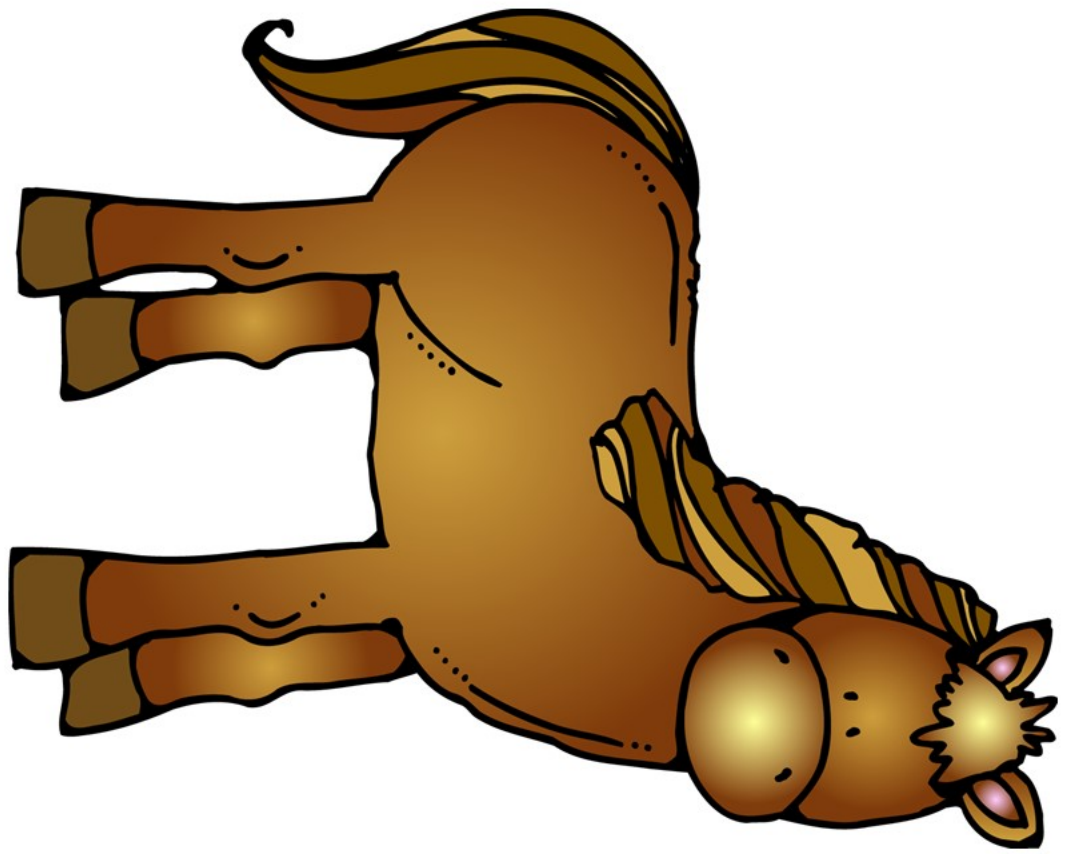



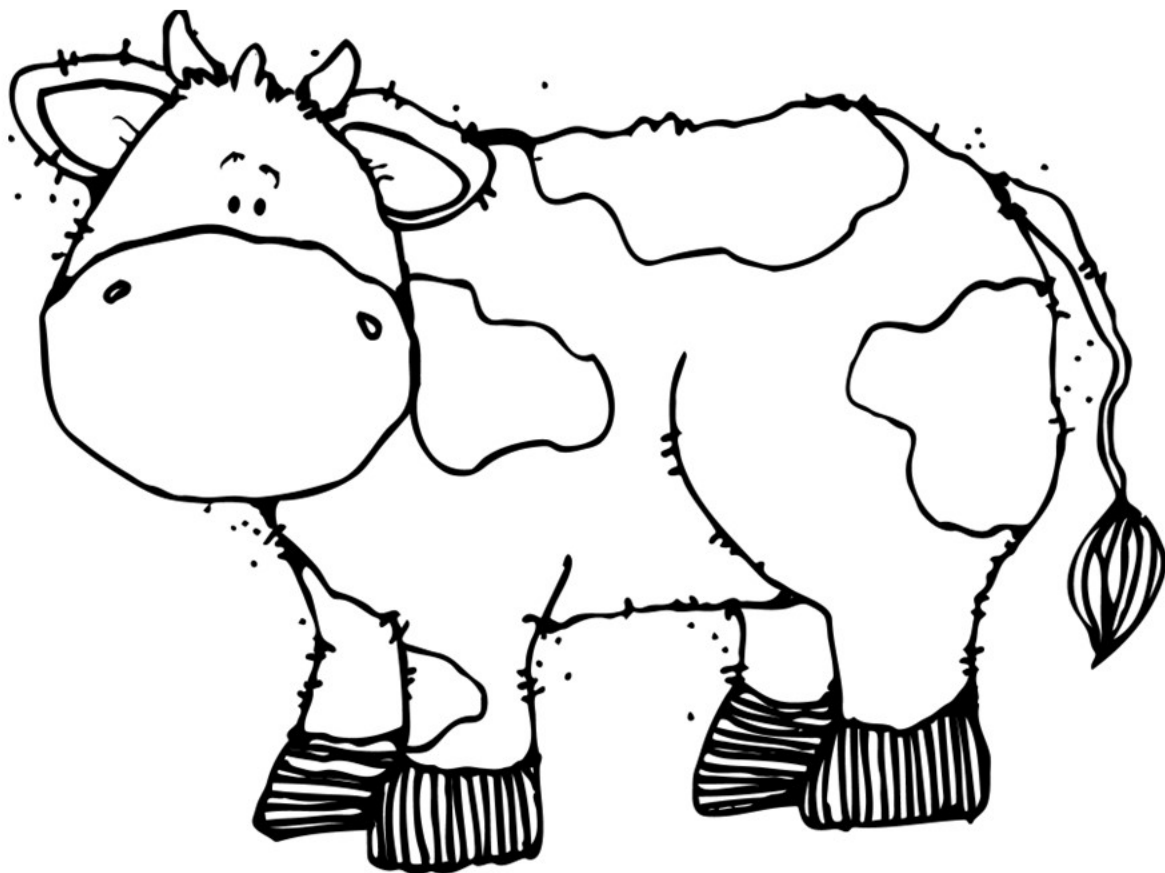
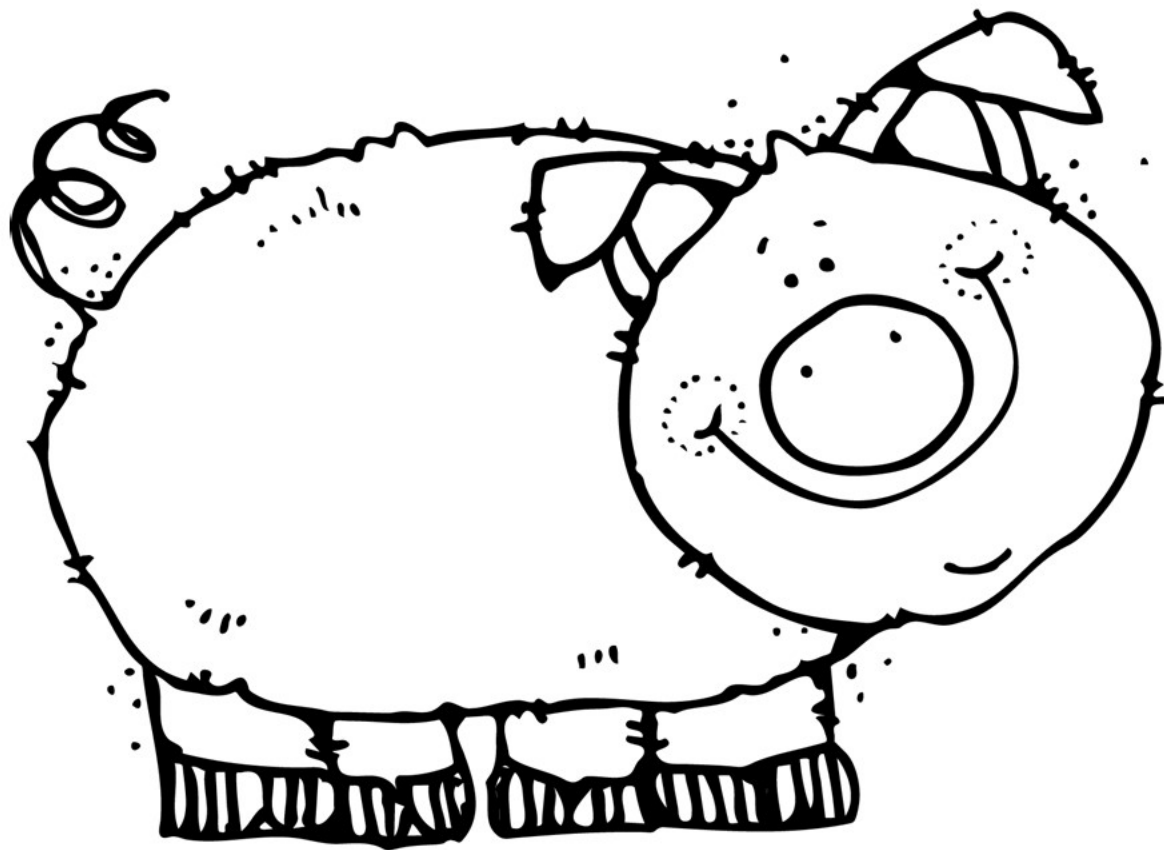

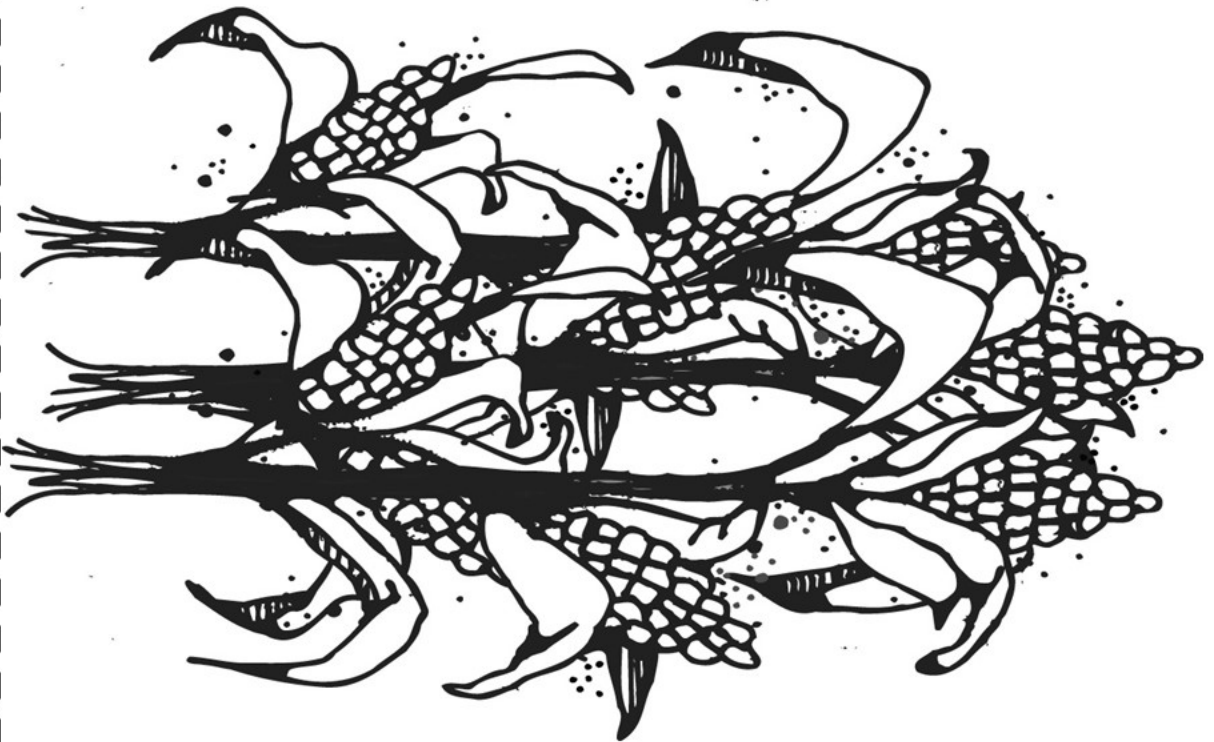
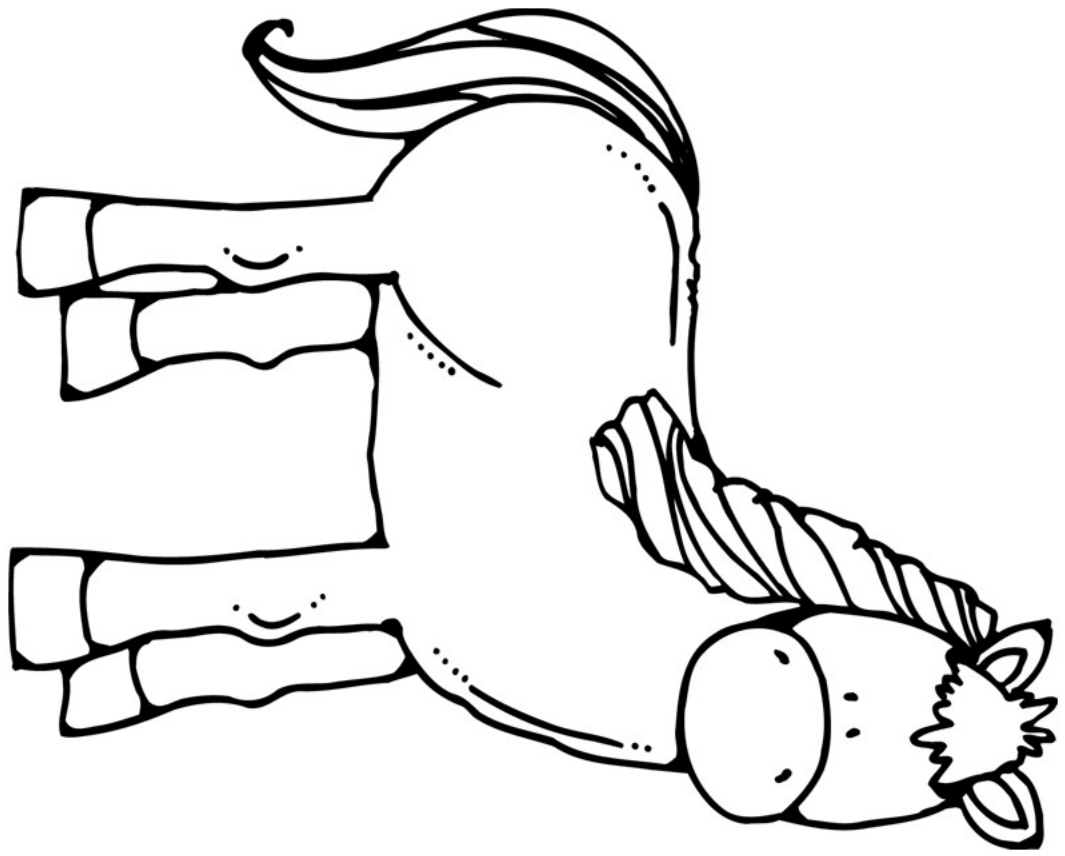

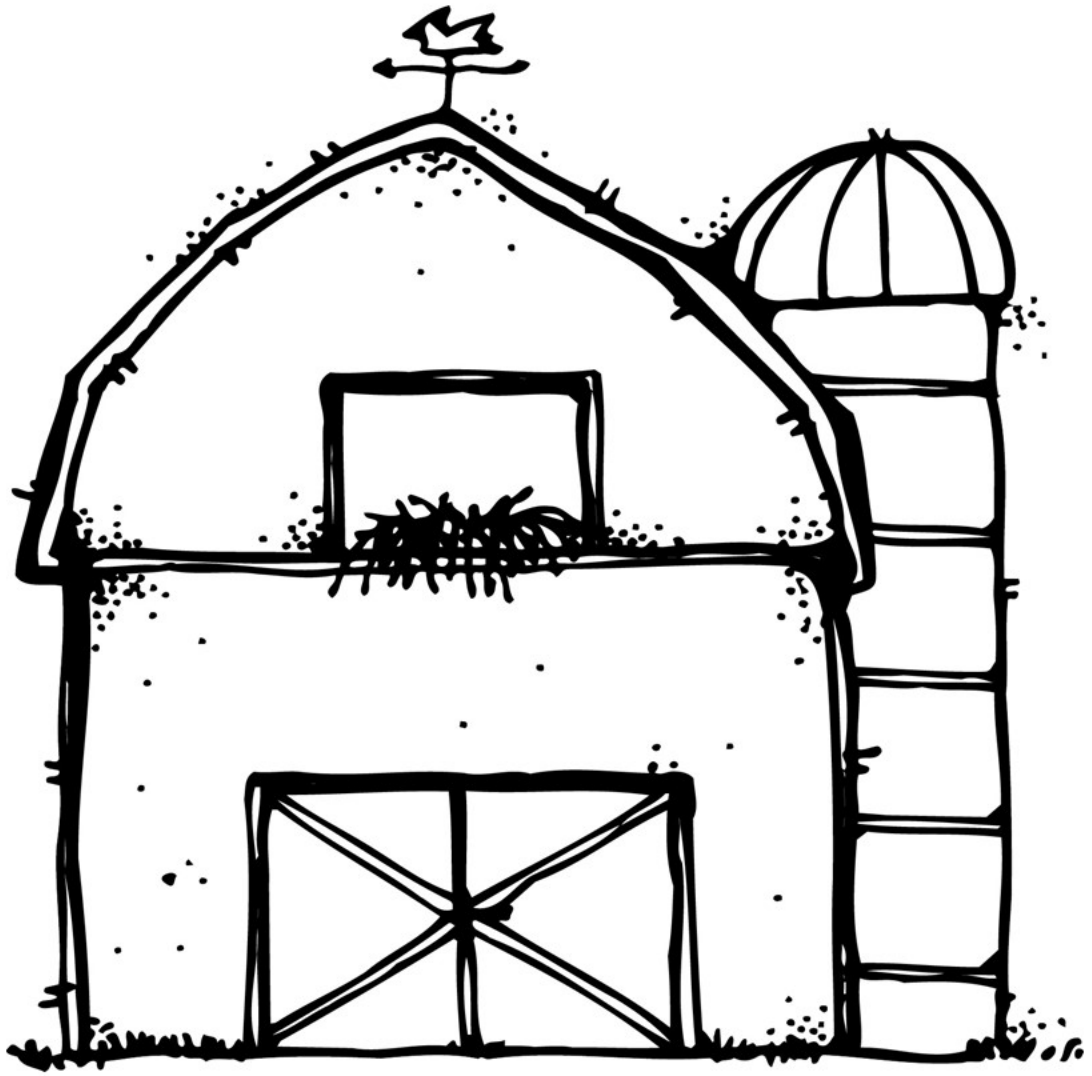

Down on the Farm
Monday
Circle Time – cont.

- Have children stand up and stretch before you start reading the story book you have chosen for the week.

Stretching Poem
Have children stand up.

Stretch my little fingers,
Stretch my little toes.
Wiggle my ears and
Wiggle my nose.

I can jump high,
And then turn and sit down.
I'm just a very good friend,
To have around!

Once children are seated, get ready to read the story. Read the title, author and illustrator. While reading the story, ask opened ended questions about the story. Encourage questions about the story, but direct children back to the book if their questions are not related to story. When story is done, circle time is done.



Cow sign language poster used with permission from
Baby Sign Language.

To purchase any sign language materials, please visit
Baby Sign Language @
<https://www.babysignlanguage.com/>

To view video for signing gift,
click on the link below:
<https://www.babysignlanguage.com/dictionary/c/cow/>

Cow



Signing: To make the sign for cow, make your hand into a fist then straighten your pinkie finger and straighten your thumb. The two extended fingers on your hand should look like the horns of a cow. Take your thumb and put it by the side of your head and twist your hand around.

Down on the Farm Posters

- You have the option of color or b & w posters.
- 2 Different size posters
- Print up on white card stock.
- B & W template color
- Laminate and hang up during the down on the farm theme.



Click on the picture above to be brought to posters
in the infant section. p. 56

Additional idea: Print pages up and staple together to make a farm color book. There is a cover for the book in color and b & w. Place a blank piece of card stock in the back for a back cover. You have 2 options. Large or small posters.

Small Groups

Purpose of small groups:

- To work and learn with a small number of children facilitated by a teacher.
- To allow teachers an opportunity to observe and assess where every child is on the road to learning to read and write.
- To allow teachers a time to use assessment results in intentionally work with specific children
- To learn the art of conversation including listening, taking turns and talking.
- To provide participation opportunities for each child.

When are small groups appropriate in the daily schedule? Small group time may be scheduled any time during the day. Set a specific time with specific groups. Small group activities are planned in advance and may continue with the daily lesson, teach a new concept, or allow children to practice skills, such as rhyming or alliteration.

How many children are in the ideal small group? Group size will vary according to the activity, but a group of 2 – 6 is an ideal size for learning and participation.

Small Group – ECIPs

ECIPs

Domain 1: Social and Emotional Development

Component: Social Competence and Relationships

Indicators: Interacts easily with one or more children * Interacts easily with familiar adults * Begin to participate successfully as a member of a group

Domain 2: Approaches to Learning

Component: Curiosity

Indicator: Show interest in discovering and learning new things

Domain 2: Approaches to Learning

Component: Persistence

Indicator: Demonstrate ability to complete a task or stay engaged in an experience

Domain 3: Language and Literacy Development

Component: Listening

Indicator: Listen with understanding to stories, directions, and conversations

Domain 3: Language and Literacy Development

Component: Emergent Reading

Indicators: Show beginning understanding of concepts about print * Understand that writing is a way of communicating

Preschool Lesson Plan – Down on the Farm – Letter of the Week Y

Week of:

Small Group	Monday	Tuesday	Wednesday	Thursday	Friday
Regroup to Revisit Focus					

Preschool Lesson Plan – Down on the Farm – Letter of the Week Y

Week of:

Small Group	Monday	Tuesday	Wednesday	Thursday	Friday
Reading Writing Game	<p><u>Read</u> My Friends on the Farm. Read together. Color <u>Writing</u> - Have the children practice writing words in My Friends on the Farm book.</p> <p><u>Activity</u> – Down on the Farm Color Match.</p>	<p><u>Read</u> My Friends on the Farm. Read together. Color <u>Writing</u> – Down on the Farm Tracing Sheets.</p> <p><u>Activity</u> – Down on the Farm Cube Pictures. You have 2 options. Built pictures or color pictures.</p>	<p><u>Read</u> My Friends on the Farm. Read together. Color <u>Writing</u> – If I Were a Farmer Sheet. Use vocabulary words included. Put vocabulary words in writing center.</p> <p><u>Activity</u> – Farm Bingo.</p>	<p><u>Read</u> My Friends on the Farm. Read together. Color <u>Writing</u> – Q-Tip Farm Painting.</p> <p><u>Activity</u> – Farm Playdough Mats.</p>	<p><u>Read</u> My Friends on the Farm. Read together. Send home.</p> <p><u>Writing</u> – Farm Letter Match.</p> <p><u>Activity</u> – Farm Graph.</p>
Regroup to Revisit Focus	Have kids share something they did/read/made in AL	Have kids share something they did/read/made in AL	Have kids share something they did/read/made in AL	Have kids share something they did/read/made in AL	Have kids share something they did/read/made in AL

Language, Literacy and Communications

L4.7 Shows interest in both pictures and text

L4.11 Offers a personal response to stories read aloud

L4.12 Actively participates in reading activities with enjoyment and purpose

K 0.1.10.10 Actively participates in group reading activities with purpose and understanding including the appropriate selection of text for personal enjoyment, interest and academic tasks

Physical and Movement Development

P5.9 Turns pages of a book.

P5.10 Grasps a crayon to scribble

P5.13 Draws freely on paper

P5.16 Draws letters and/or part of name with some reversals

Active Learning - Regroup

Purpose of regroup:

- To get children to talk about what they did during the day.
- To help children remember what they did during the day, so that when parents ask what they did during the day, hopefully parents will not get the automatic response "nothing".

When is regrouping appropriate in the daily schedule? Regroup with children before naptime, when you have 10 minutes to sit and talk about what they did that morning. What was the best part of their day? Get the children talking about their day.

You can also regroup in the afternoon after nap and snack, before children start going home for the day. Pick the best time in your child care / preschool to re-connect with the children.

My Friends on the Farm Book

Book comes in 2 formats

- B & W for children with dotted words
- B & W without dotted

Pick the template you want to print for each child..

1. Print first 2 sheets back-to-back. Fold in $\frac{1}{2}$.
2. Print the next 2 sheets back-to-back. Fold in $\frac{1}{2}$.
3. Print up last 2 pages back-to-back. Fold in $\frac{1}{2}$ place pages inside the cover making sure they are in order before you staple.

Please note: Use the book format that works best with each child. Older children can practice writing the words without the dashes.

Staple if desired. (You will need a longer stapler in order to do this. Can be purchased at Office Max or other office supply store).

Includes color teachers copy.

My Friends on the Farm Book

Supplies needed:

- White paper (or card stock)
- Color crayons, markers or colored pencils
- Long nosed stapler for stapling the book together



Directions:

Print up copies of the My Friends on the Farm book, one for each child. There are 2 templates - with or without words for writing.

Read the book together as a group.

Have children color the pages and write the words.

Send home with each child at the end of Down on the Farm theme.



With printed words.
(For younger children)

I love farm life!

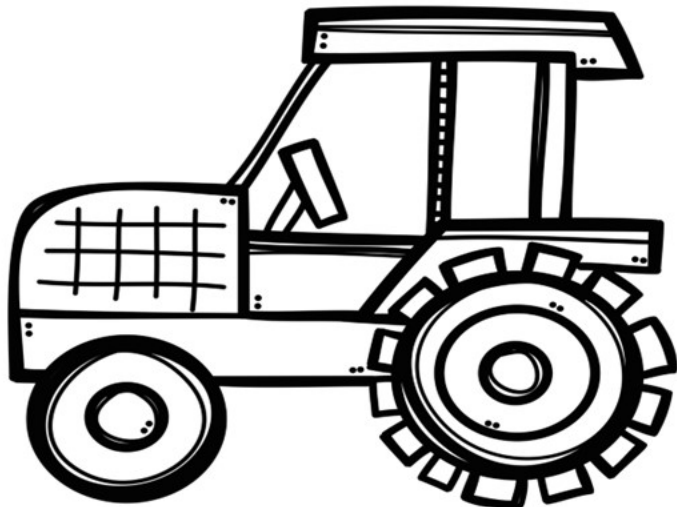
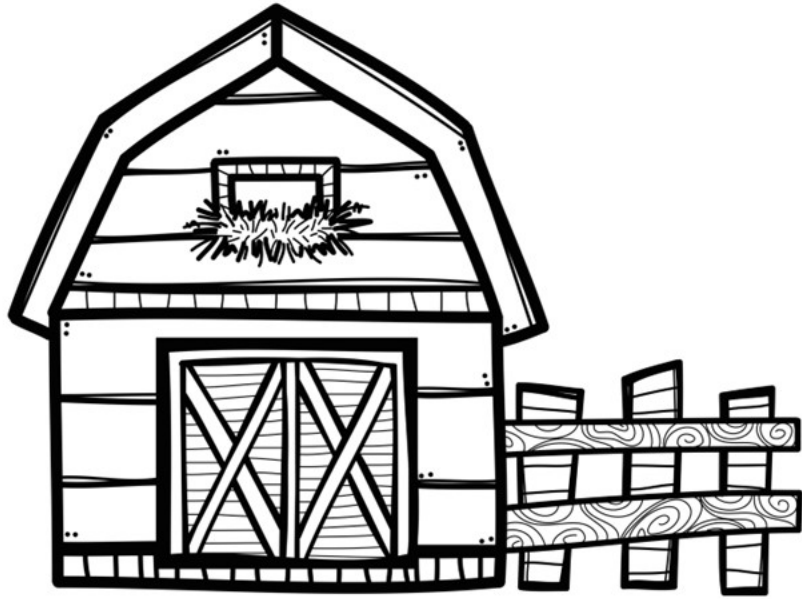

My Friends on the Farm

By

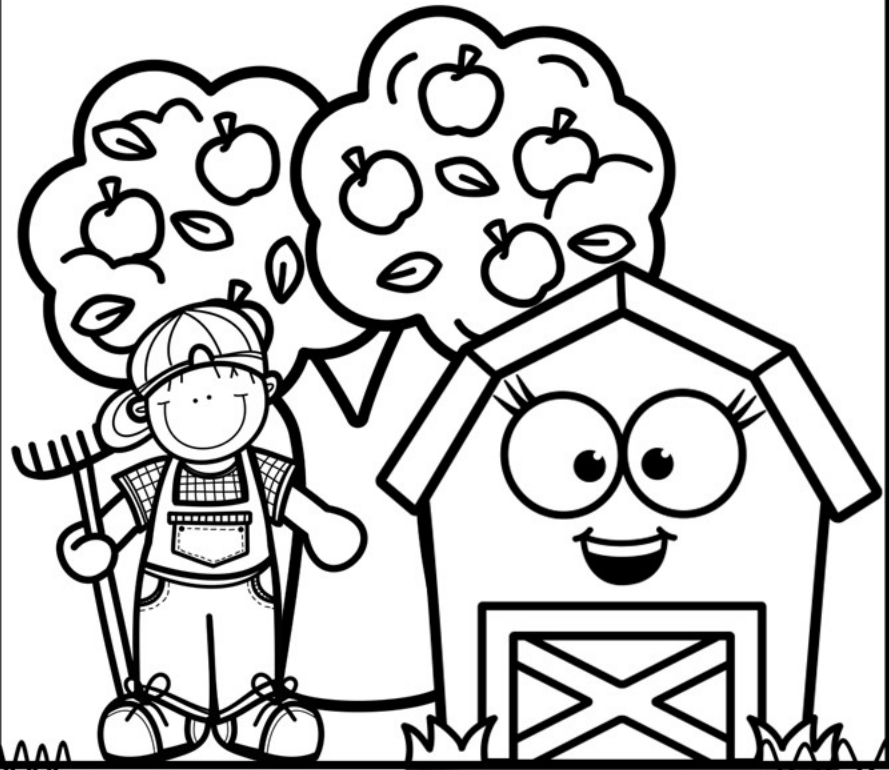

I see a farmer.



farmer

farmer

I see my friends.



friends

friends

I see a rooster.

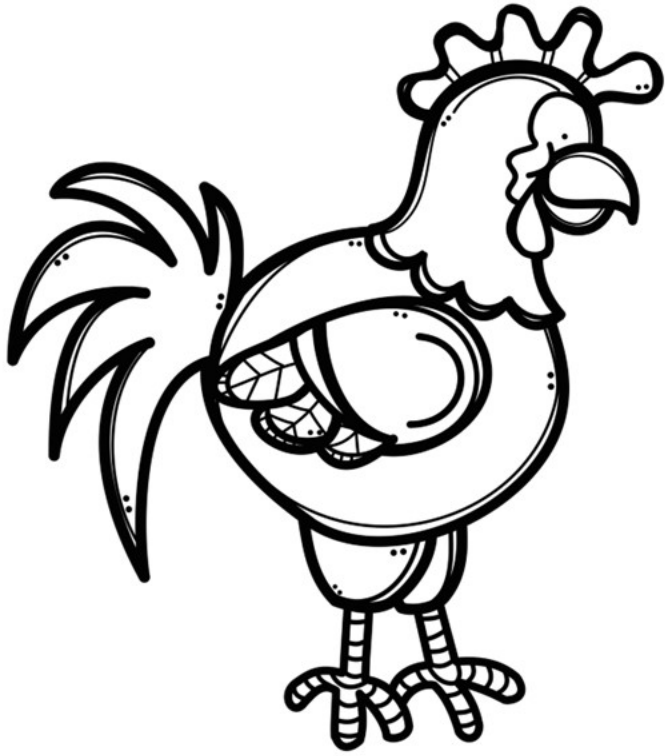

rooster

rooster

I see a cow.

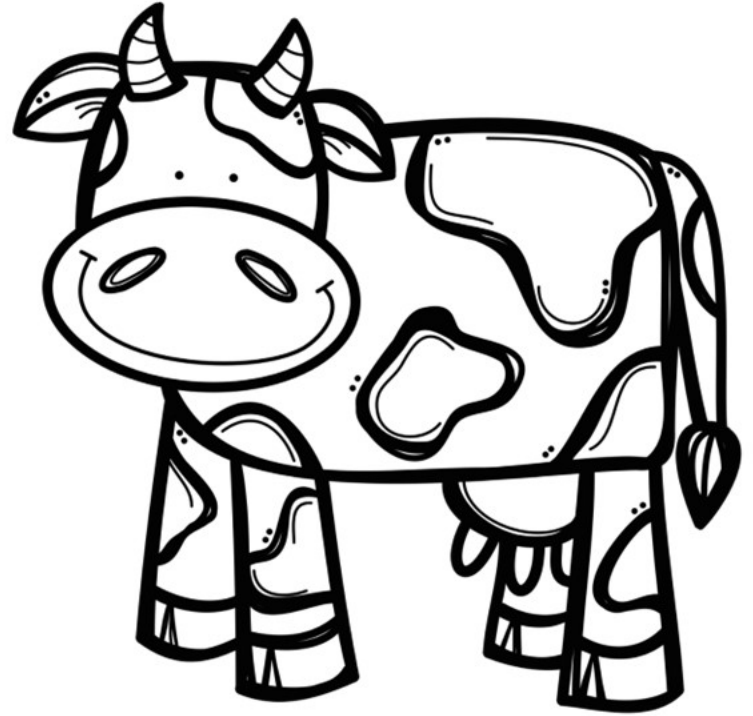

cow

cow

I see a pig.

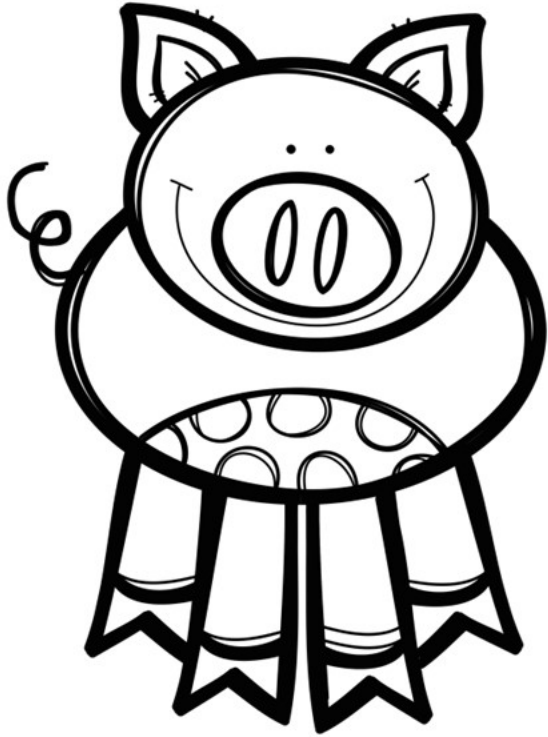

pig

pig

I see a horse.

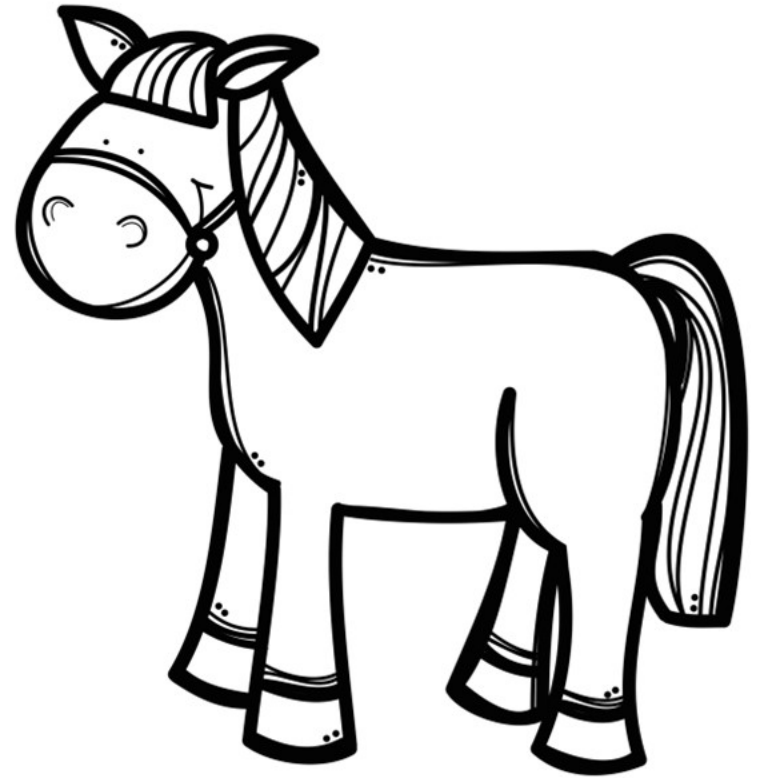

horse

horse

Without printed words.
(For older children)

I love farm life!

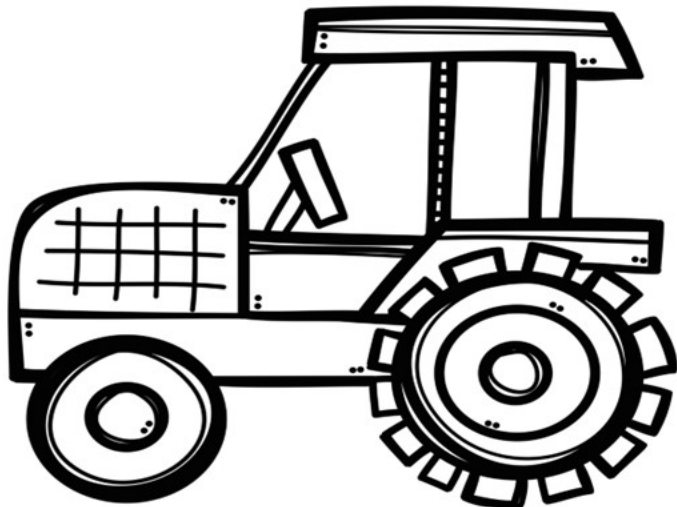
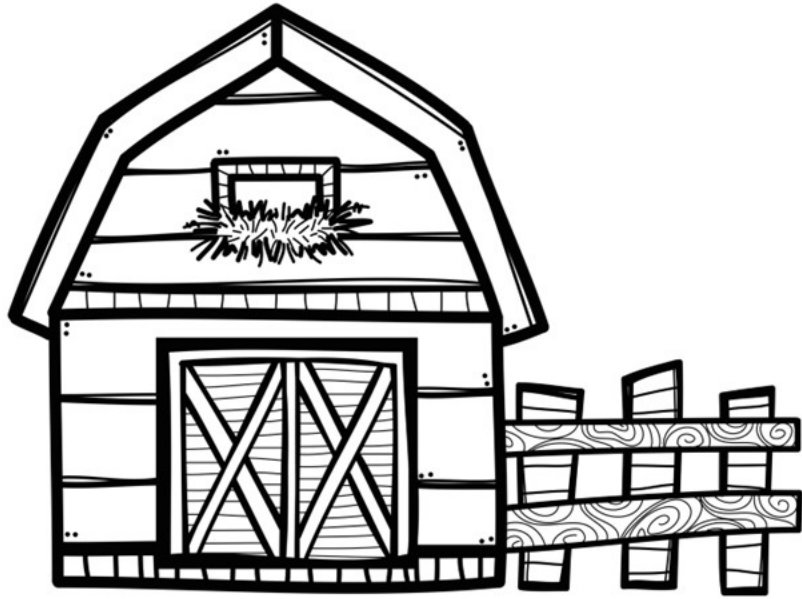

My Friends on the Farm

By

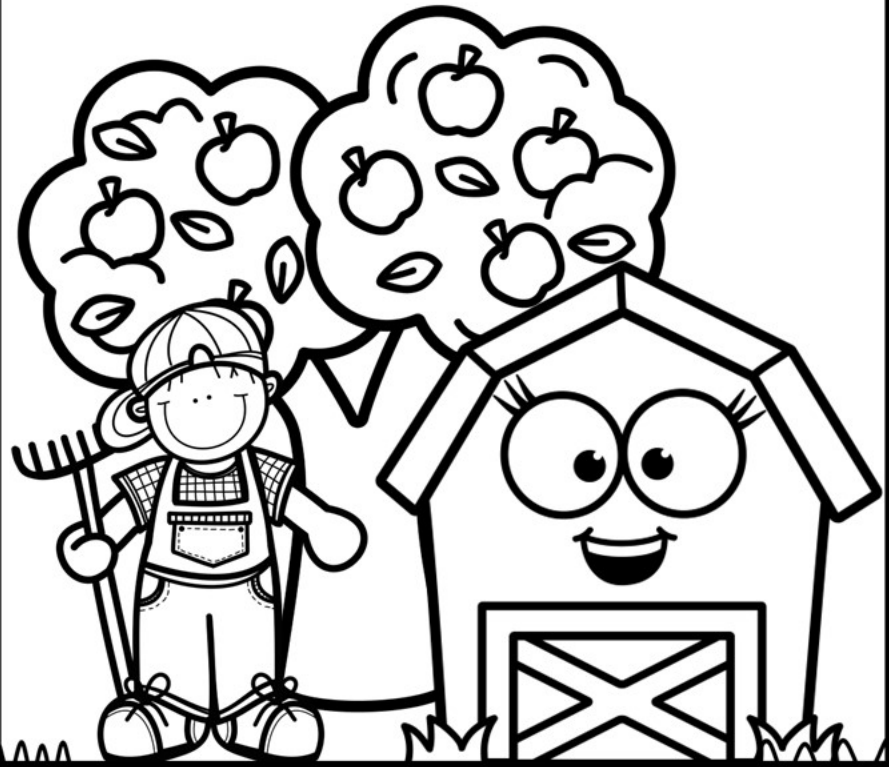

I see a farmer.



farmer

I see my friends.



friends

I see a rooster.

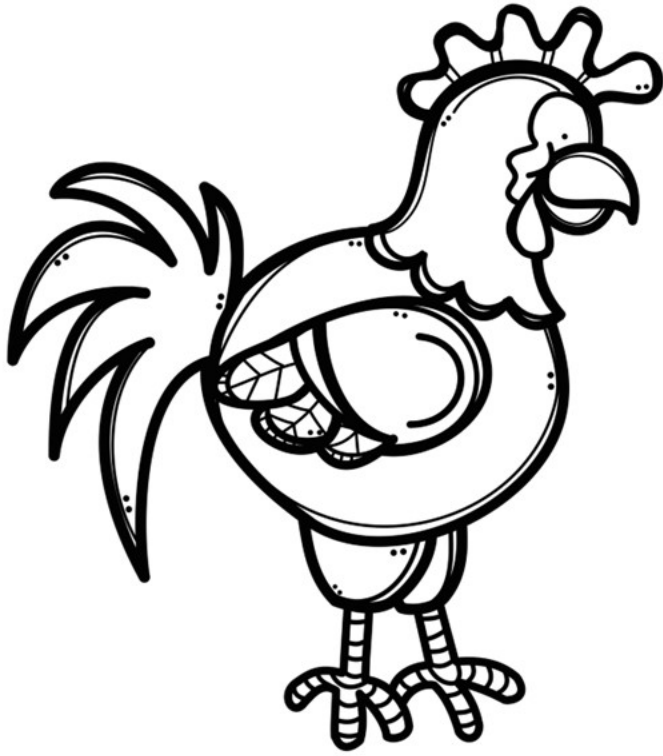

rooster

I see a cow.

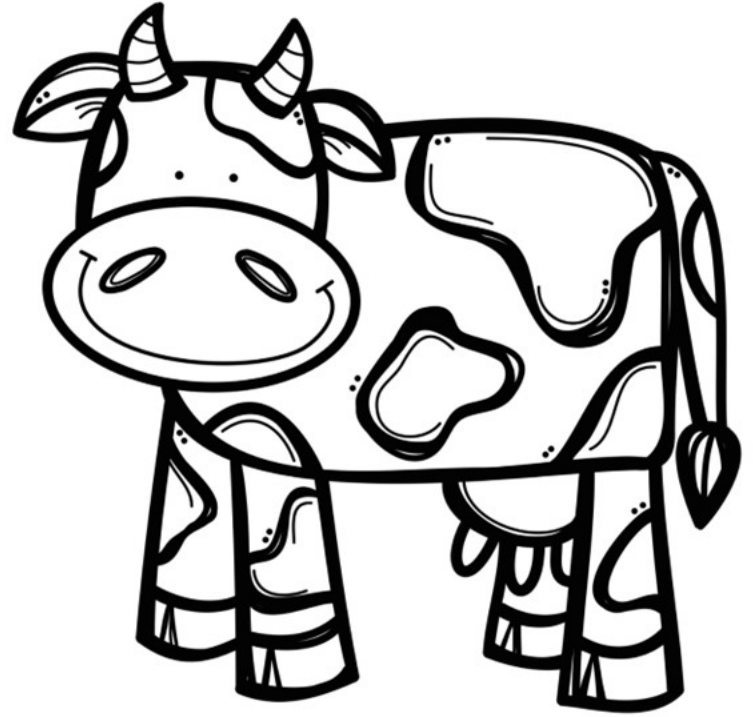

COW

I see a pig.

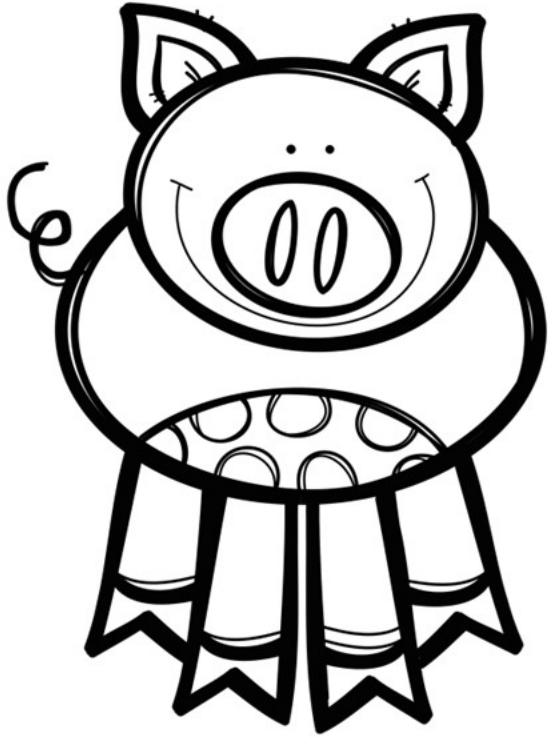

pig

I see a horse.

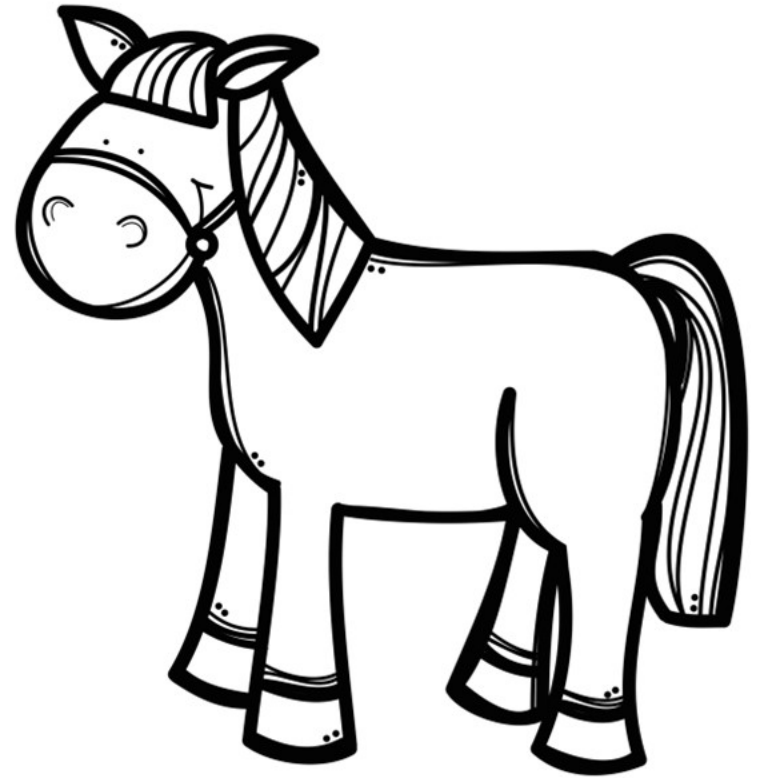

horse

Book – Teachers Copy

- Print up on white card stock.
- Put together.
- Use teachers copy during small group when reading story.

I love farm life!

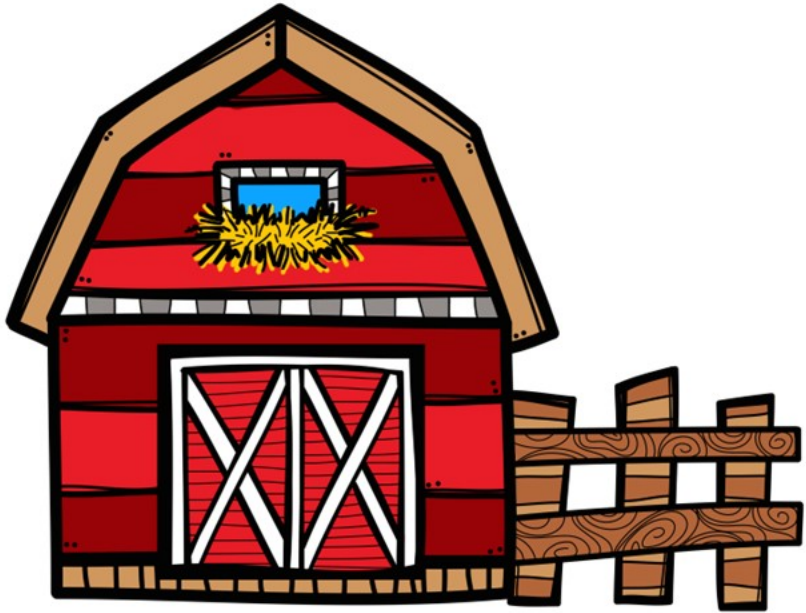

My Friends on the Farm



I see a farmer.



I see my friends.

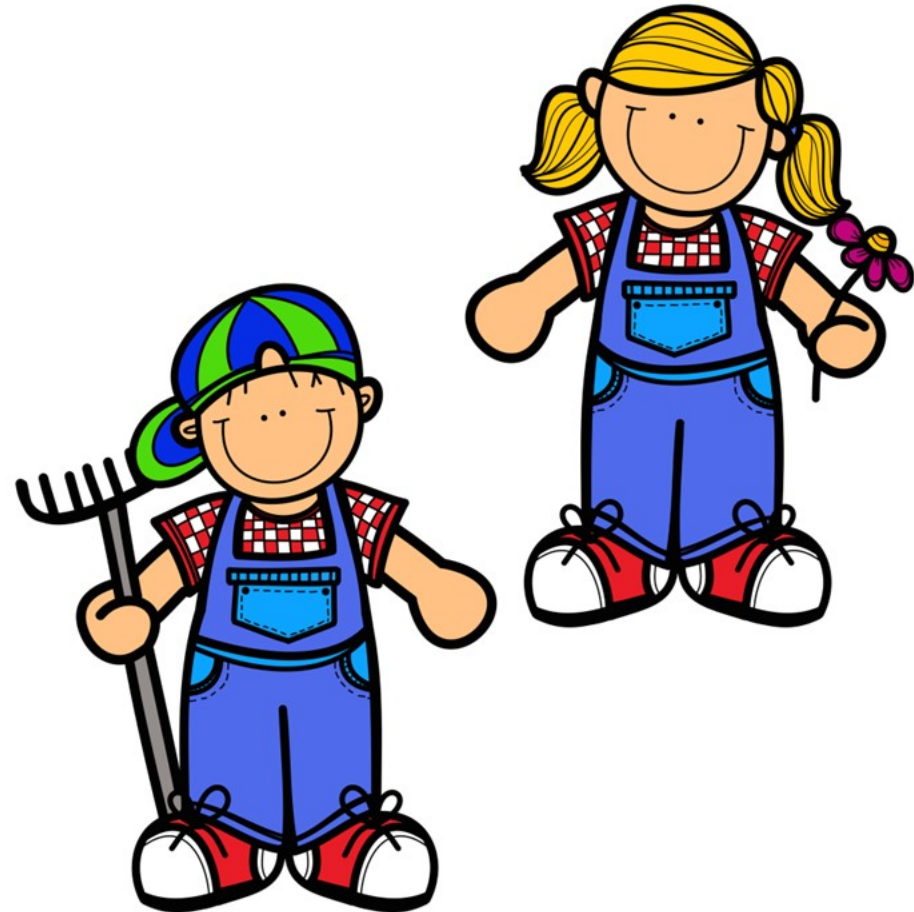

I see a rooster.

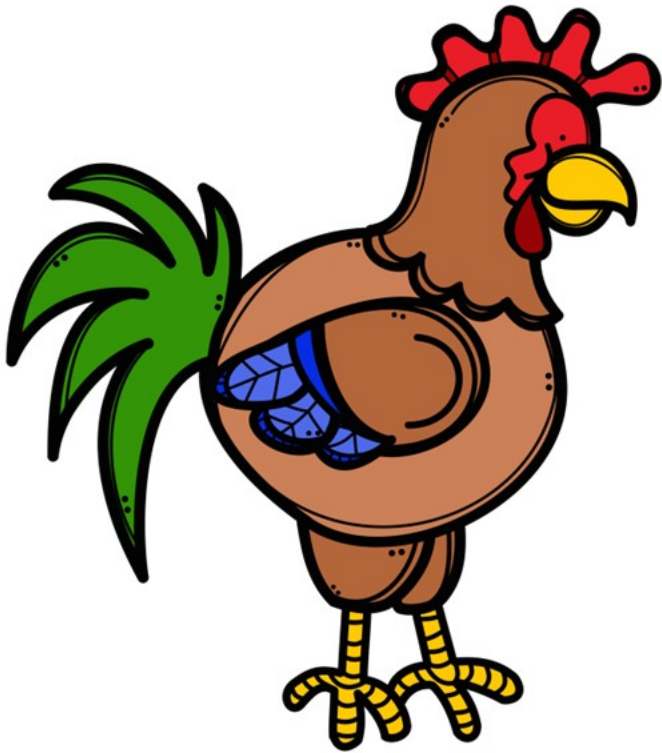

I see a cow.

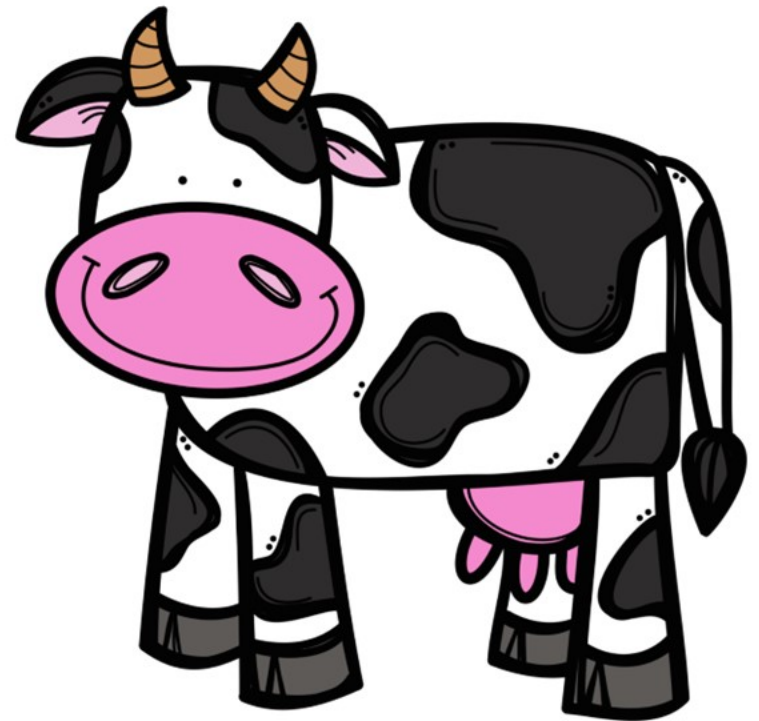

I see a pig.

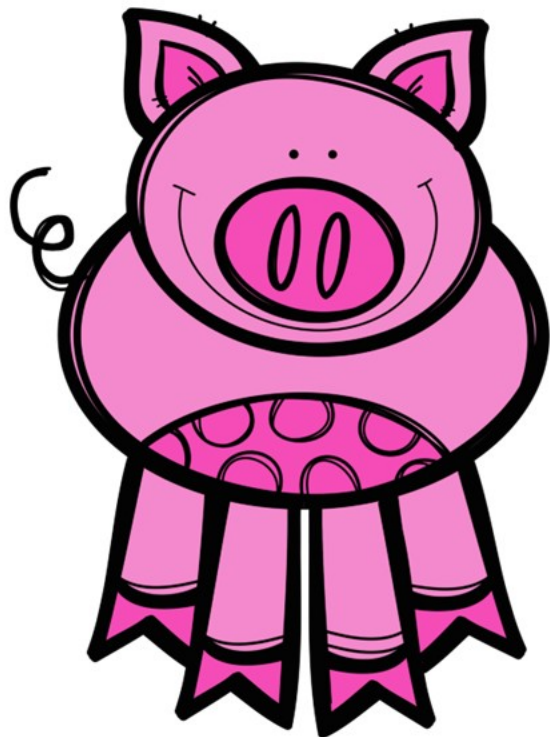

I see a horse.



Farm Color Match



Supplies needed:

- White card stock
- Laminating sheets
- Pom poms, play dough or paint daubers.
- For b & w color match template – crayons/markers plus stickers.



Directions:

Print up color match template on white card stock.

Laminate.

Have children sit at the table with a copy of the color match template.

Decide what you are going to use ahead of time.

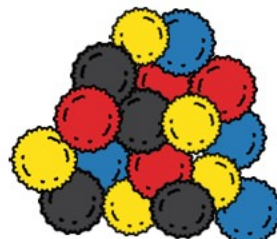

Are you going to use play dough, pom poms or daubers? You will need red, blue, yellow, green, black or whatever you decide to use.

Have children take the items they are using and cover the color circles on the farm picture with the correct color. If using play dough, have them roll the play dough into balls and place on the template. Pom poms, place the correct color on the template and paint daubers, paint the circles with the correct paint dauber. Keep baby wipes available to wipe off the paint daubers to use again.

You can also use the b & w template. Print up on white card stock. Have children color with crayons or markers. Have children place stickers on the circles. Whatever colors they would like to use to make a colorful farm.

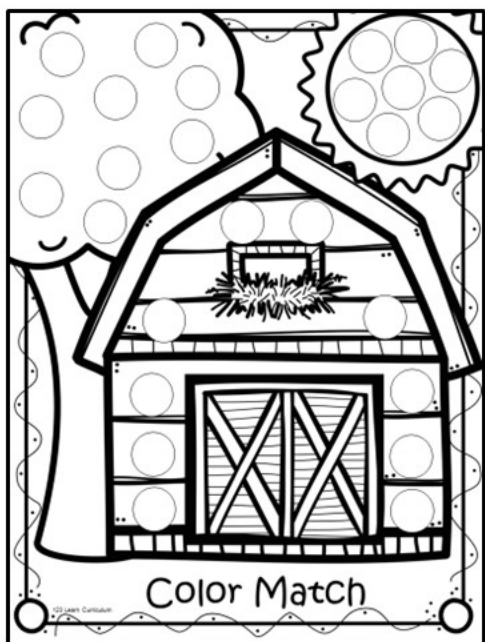

Sample of stickers available from Amazon. Click on picture to purchase.

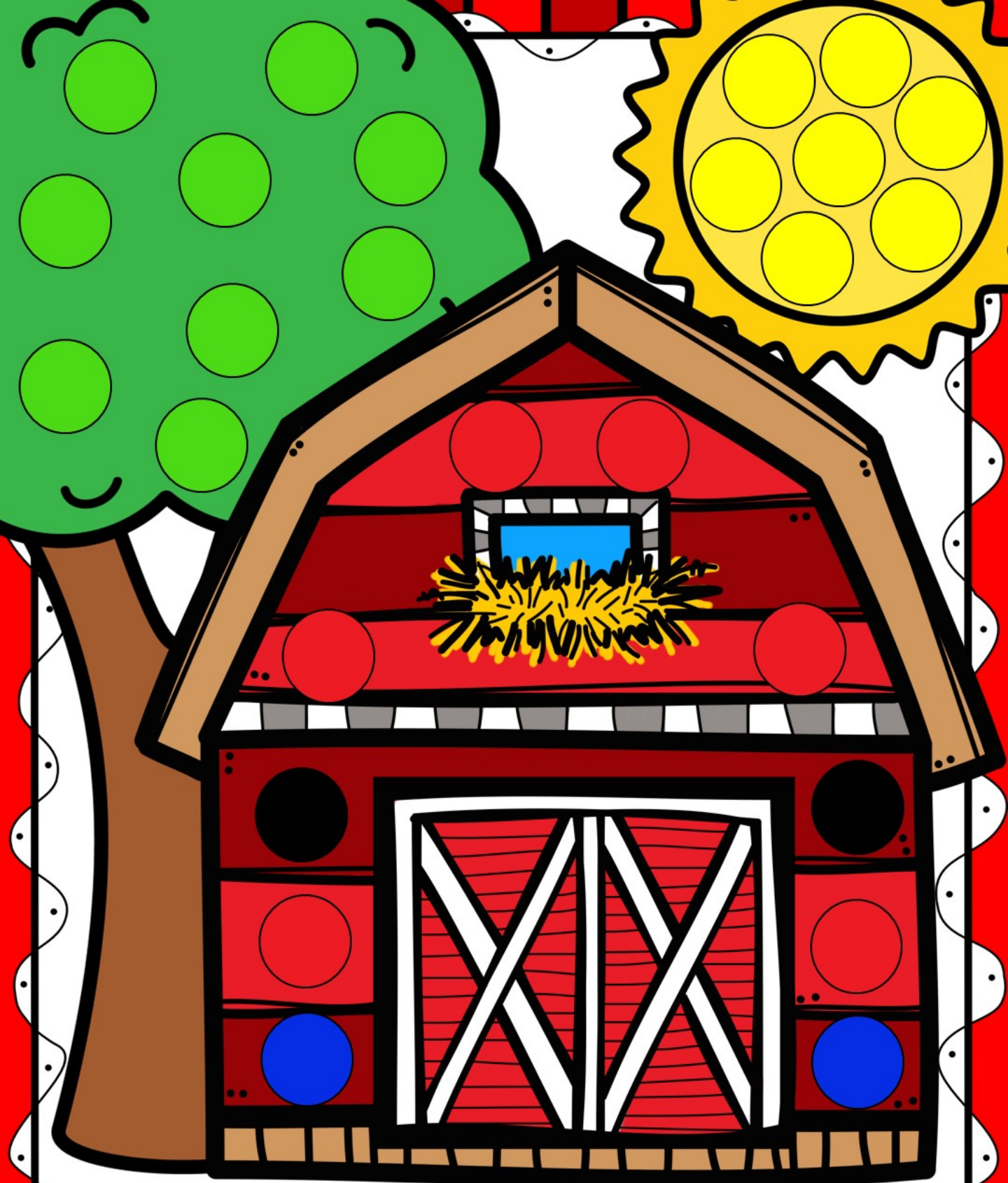

Color Match

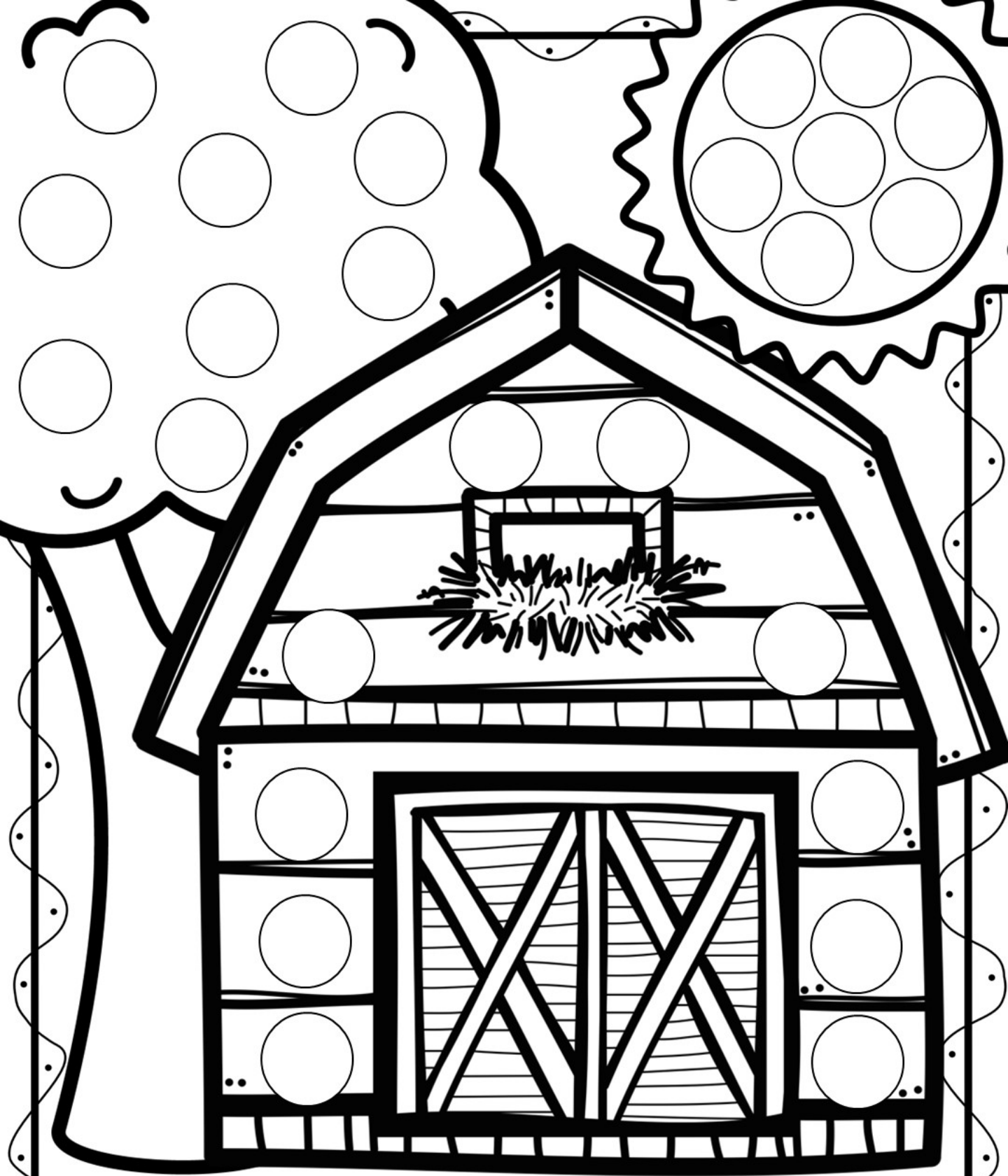

Color Match

Down on the Farm Tracing Sheets

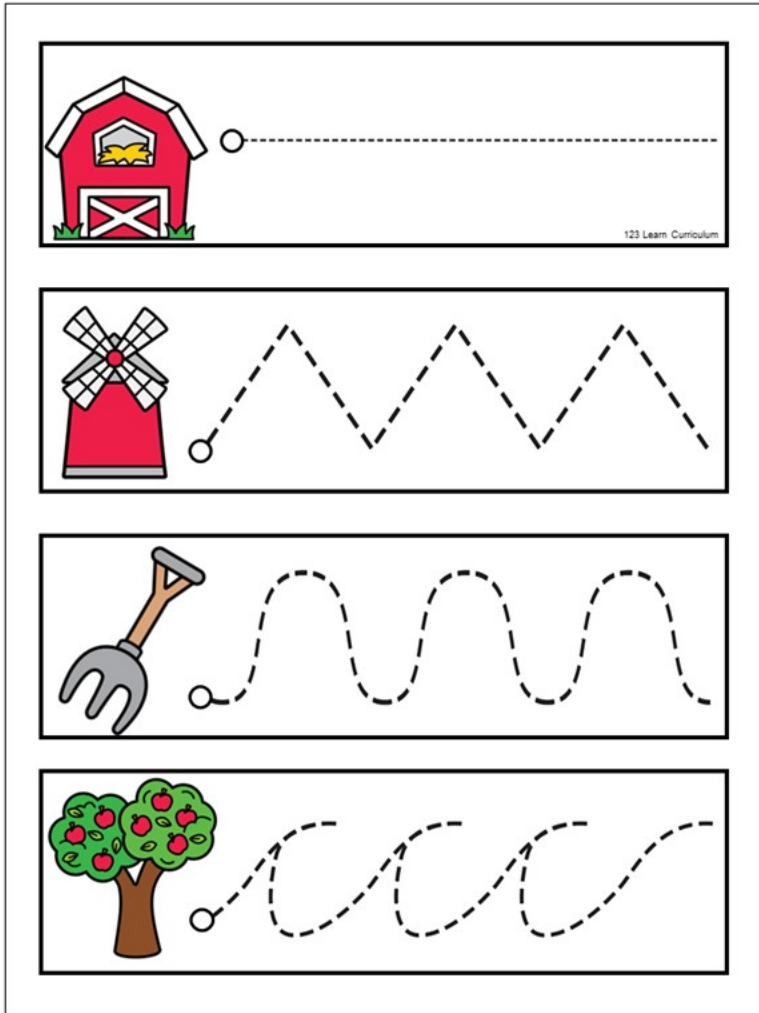

Supplies needed:

- White Card Stock
- Scissors
- Laminating sheets or top loading pockets
- Dry eraser marker
- Eraser



Directions:

1. Print up tracing strips onto white card stock.
2. Cut out and laminate.
3. Place in writing center in a basket with dry eraser markers and eraser for children to practice pre-writing skills.



Alternate idea:

Place full printed tracing sheet into a dry eraser pocket.
Have children trace and eraser.

(Saves you from laminating and can be used over and over again with other dry eraser sheets).

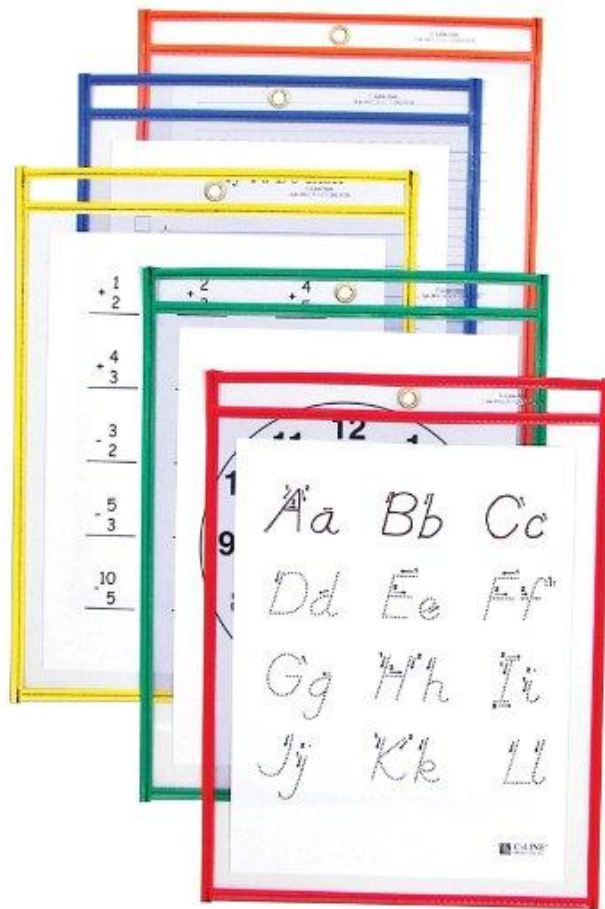

Available from [Amazon.com](https://www.amazon.com)

Click on picture to purchase online. You will be prompted to allow – click on allow and you will be taken to the dry eraser pockets.



123 Learn Curriculum

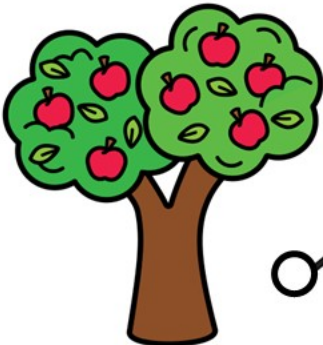

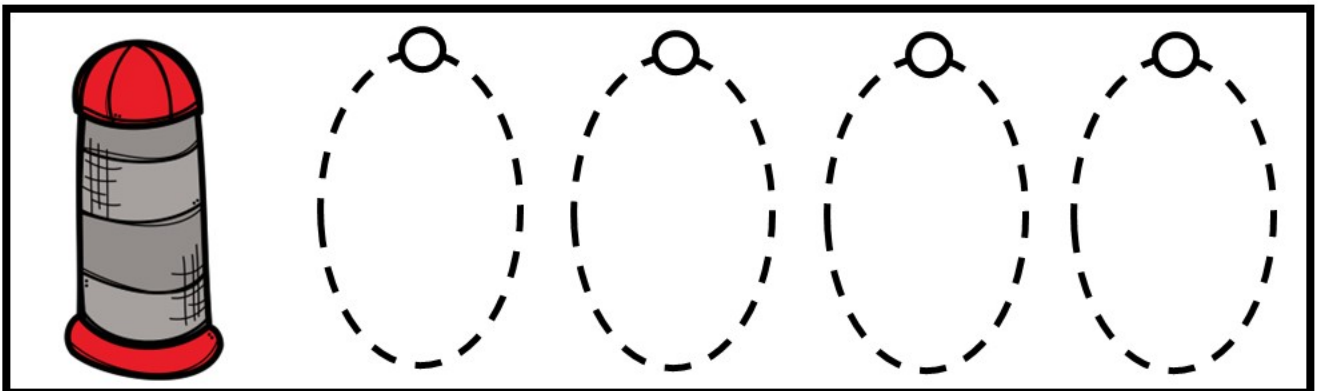
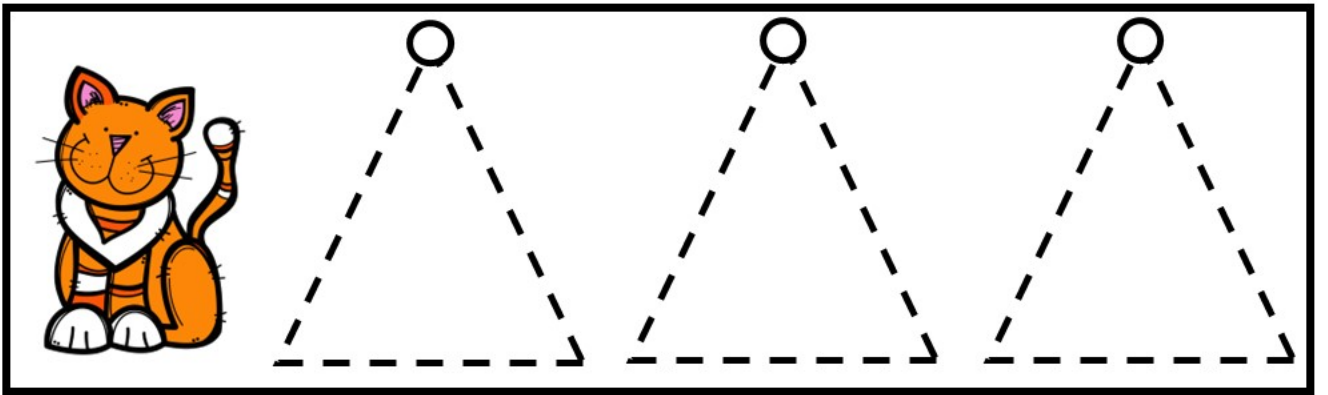
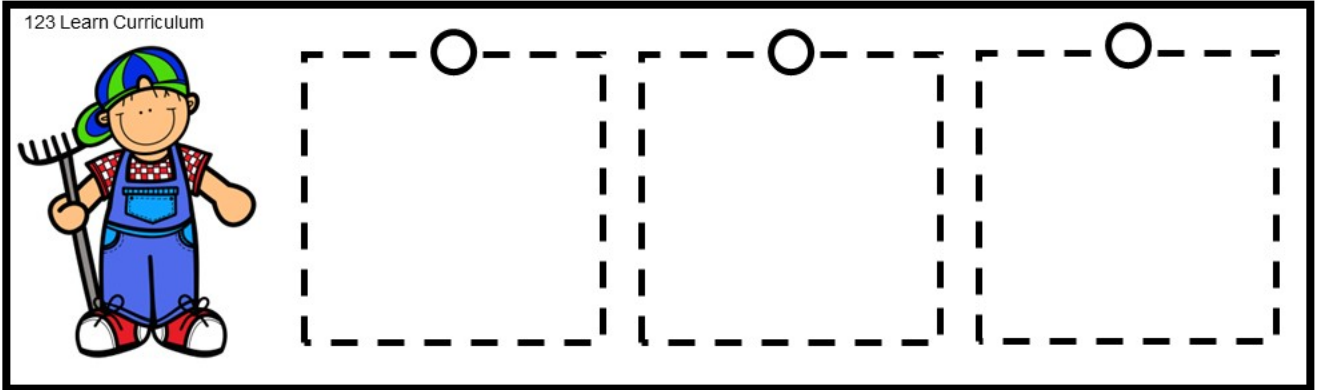
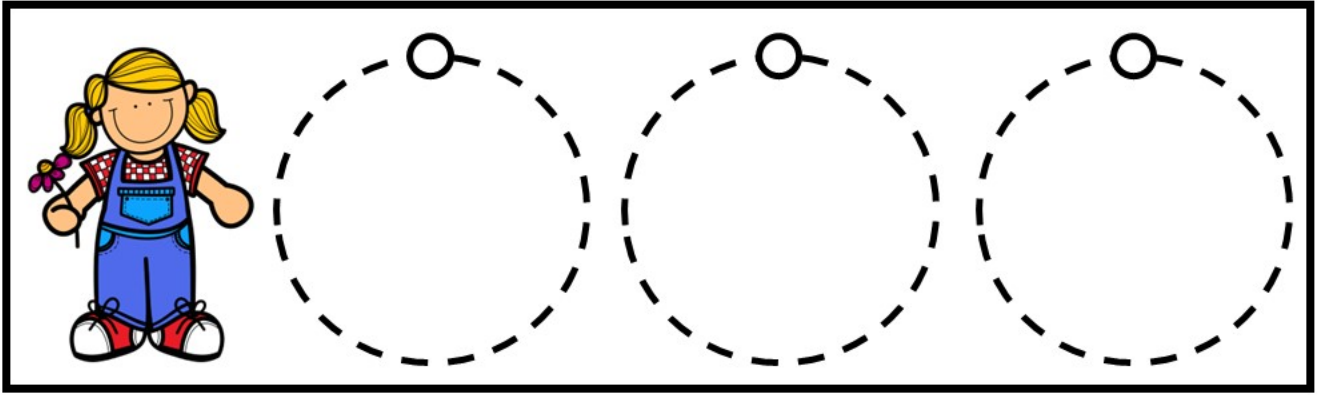

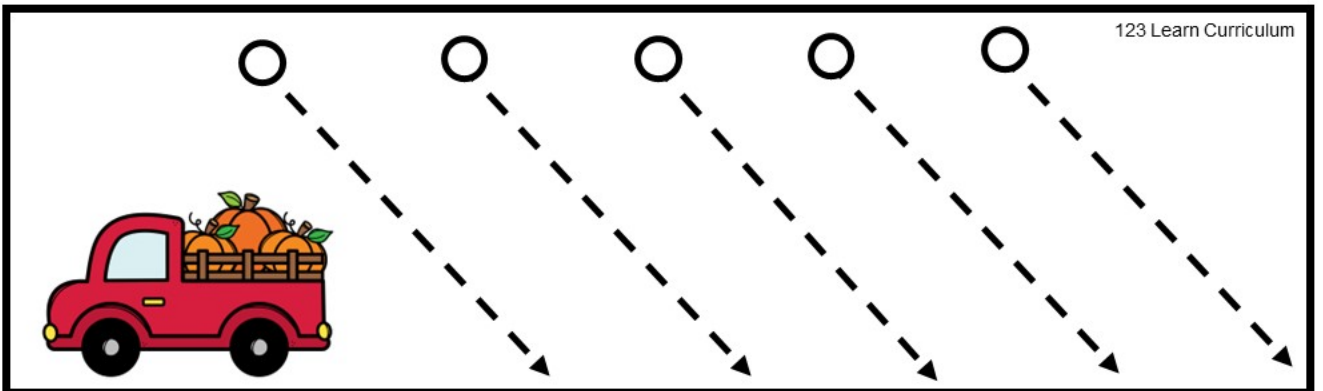
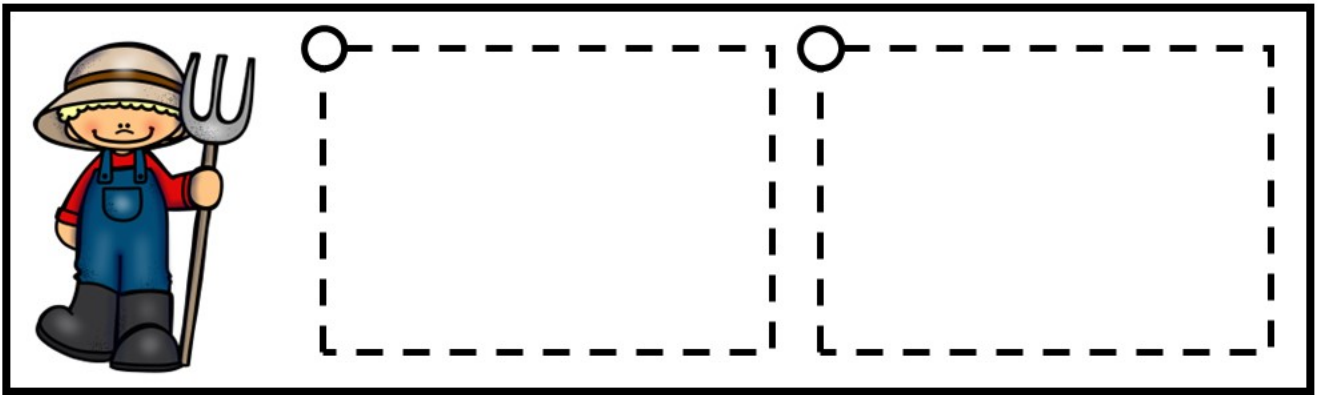
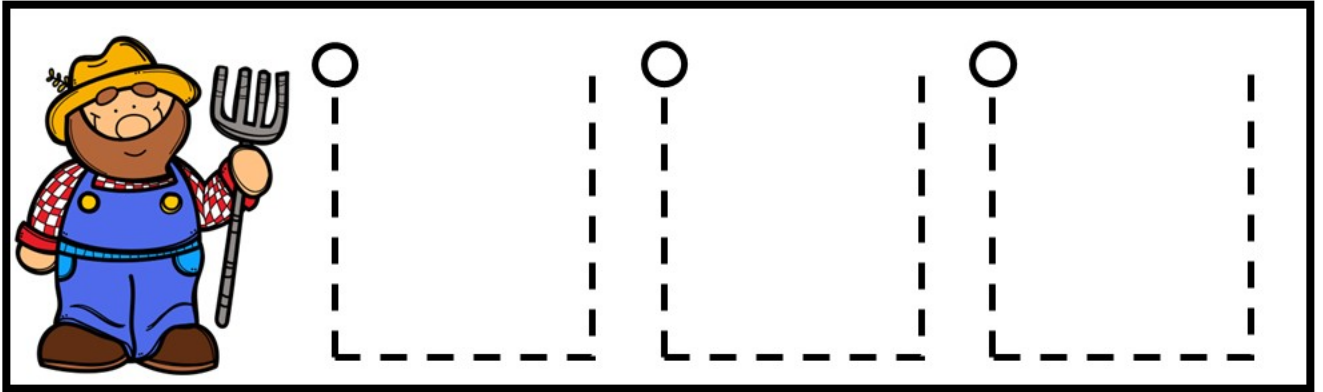
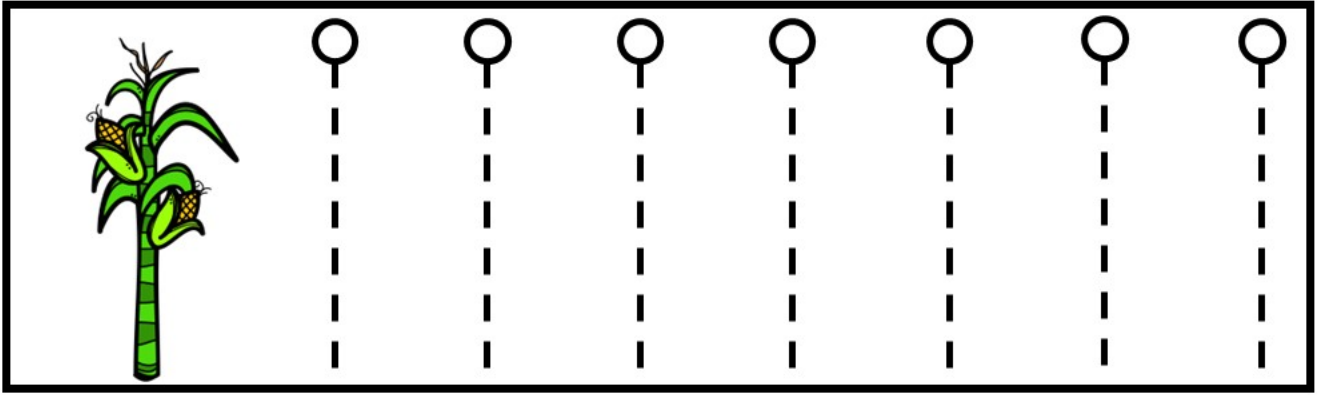

Down on the Farm Tracing Sheets

B & W sheets.

Print up on regular copy paper.

Give to children to color and trace.



123 Learn Curriculum

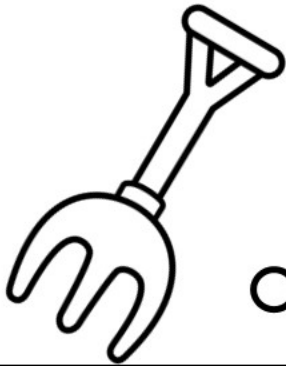
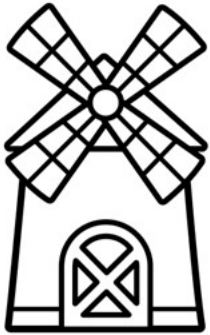

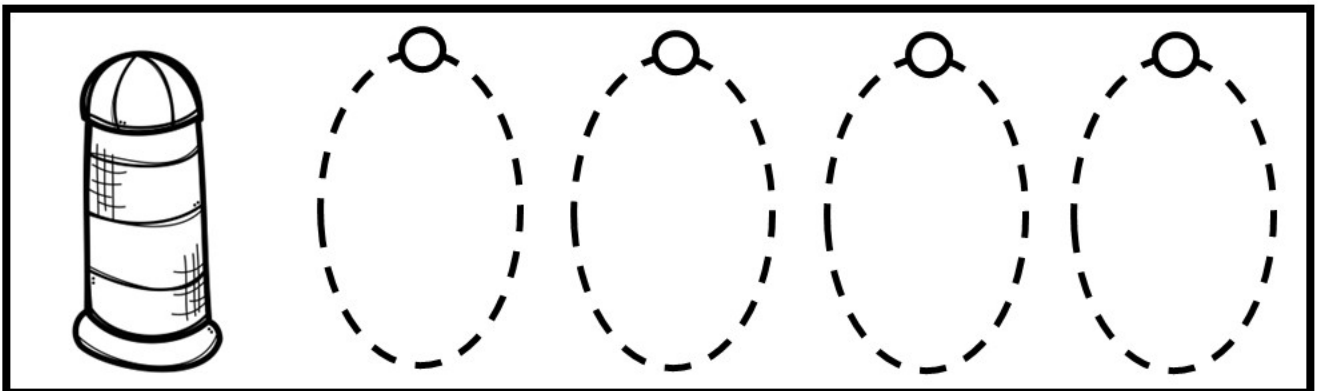
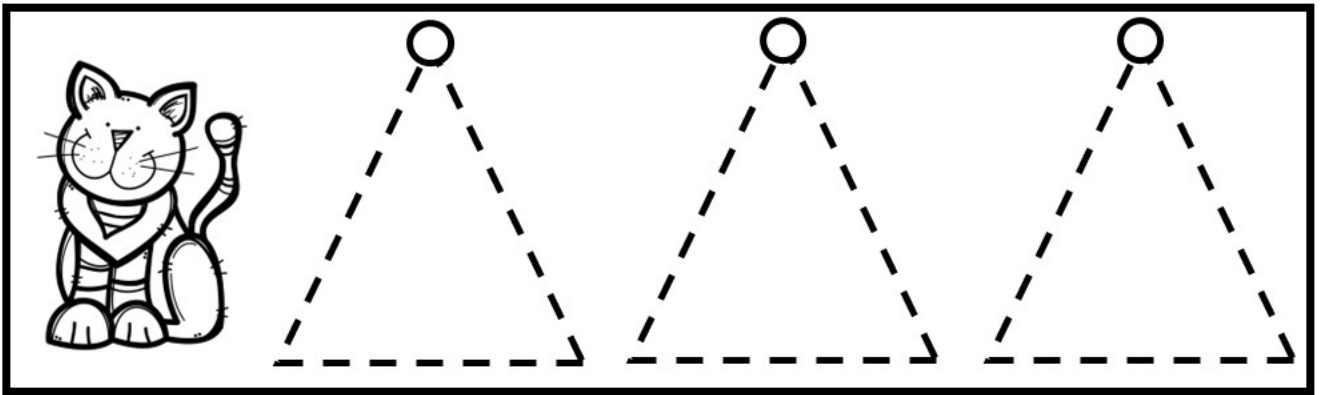
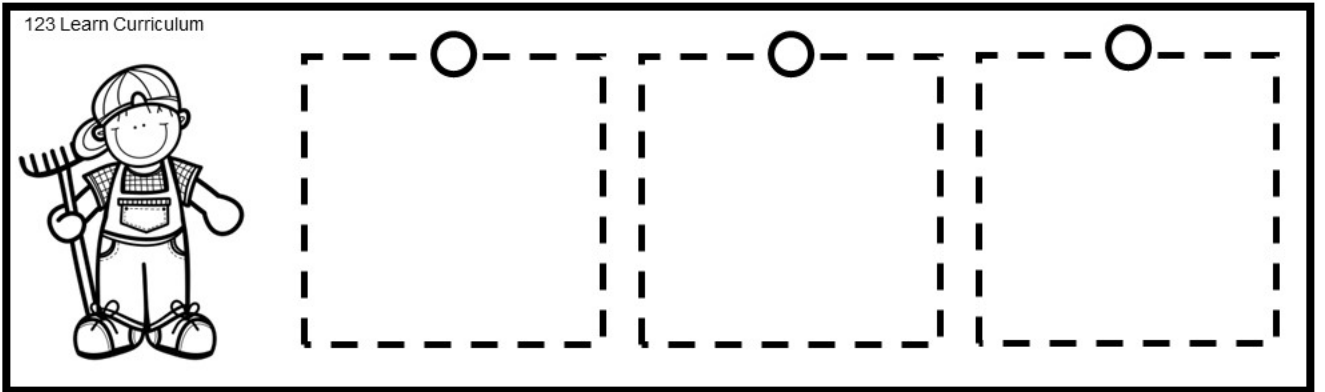
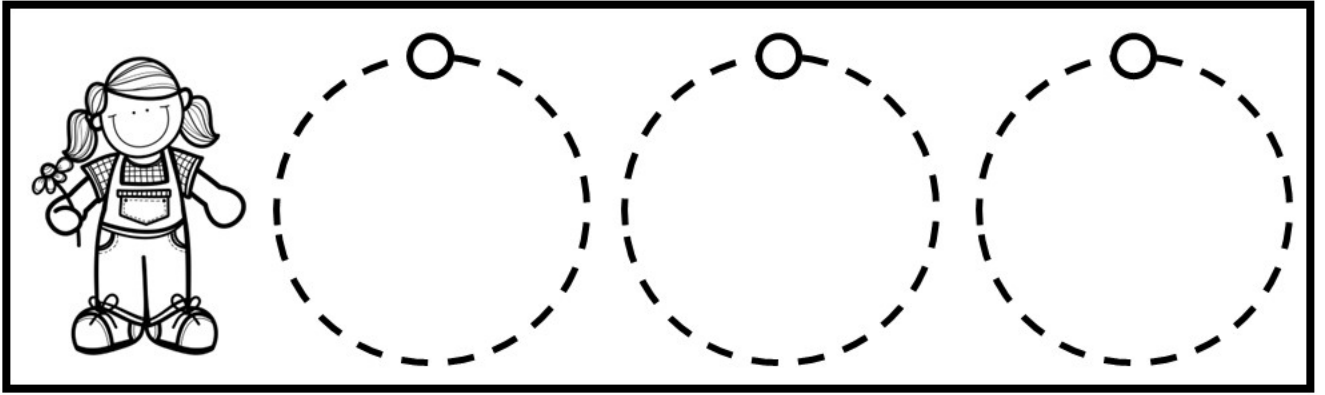

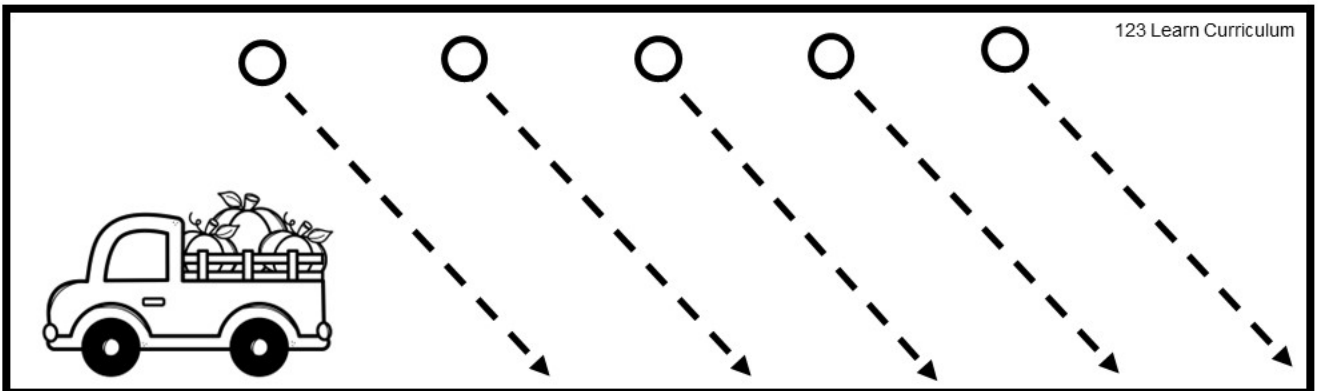
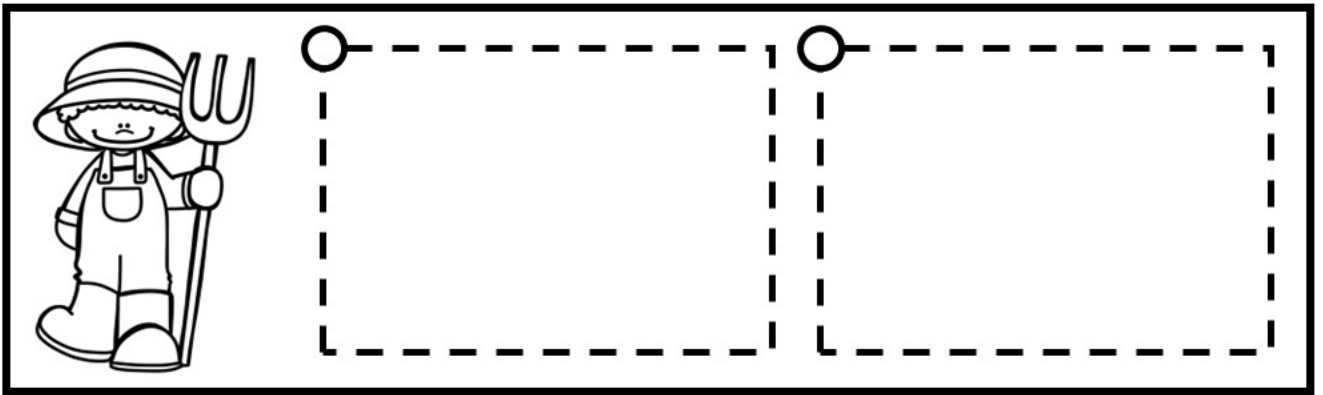
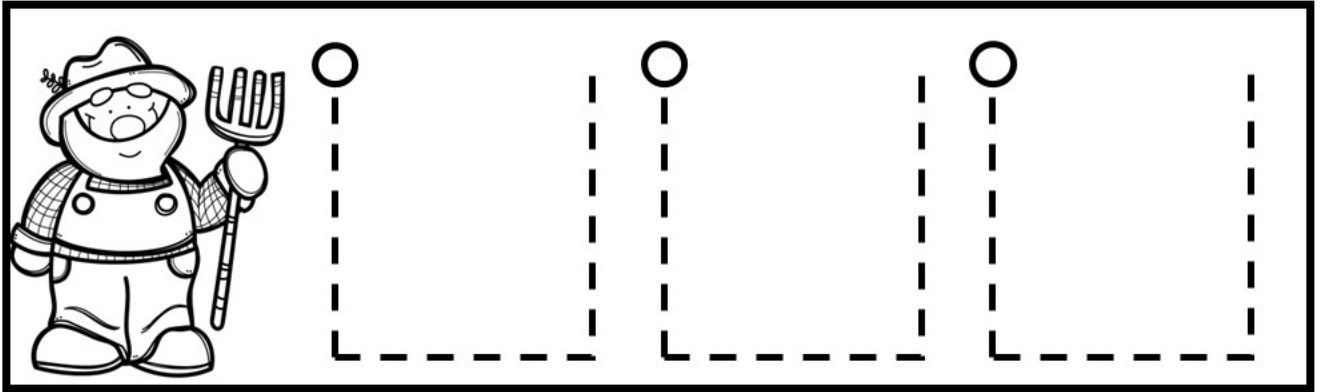
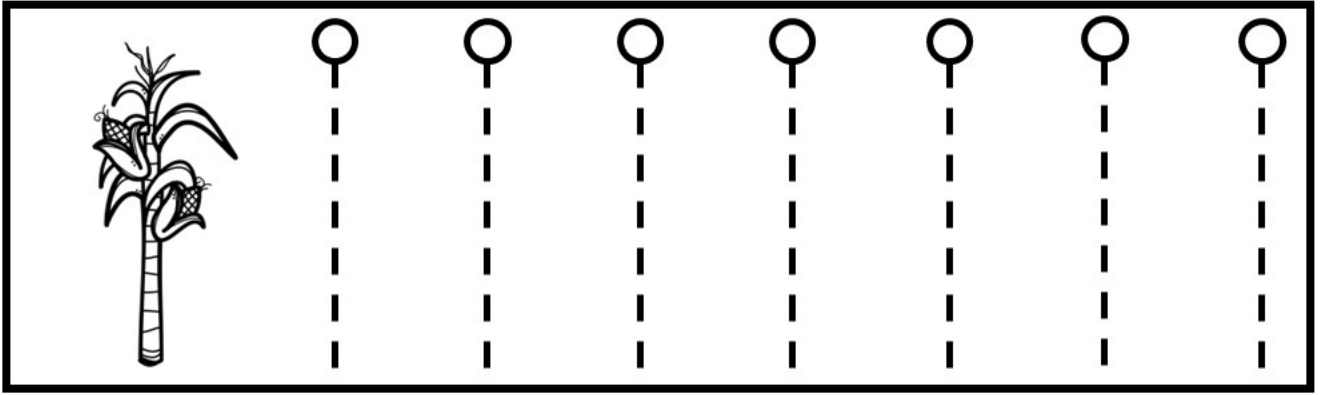

Down on the Farm Cube Pictures

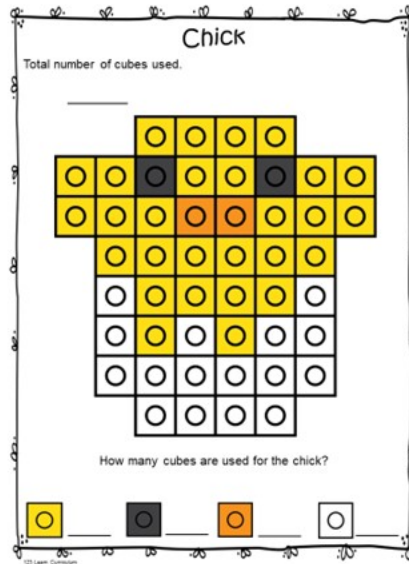
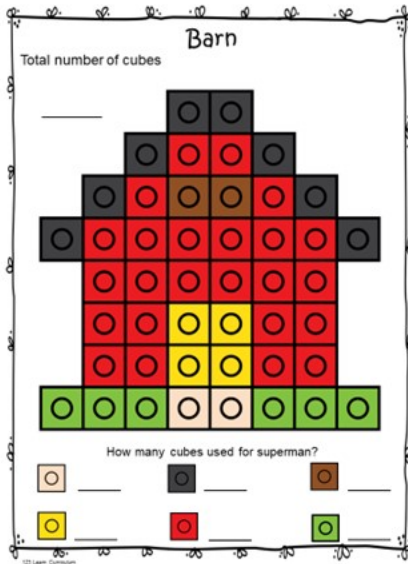

Supplies needed:

- White card stock
- Laminating sheets
- Mathlink cubes
- Dry eraser marker
- Eraser

Directions:

- Print up Mathlink mats onto white cardstock.
- Laminate and trim.
- Have children sit at the table and using the Mathlink cubes, create the picture on each card. Place the correct color Mathlink cube on each square. (Older children can snap cubes together to create the picture. They can use the card as a diagram).
- Have kids count the color of each cube used and write the number in the space provided. Count the total number of cubes used and write in space provided.

Mathlink cubes are available on Amazon.com. To purchase, click on the picture.

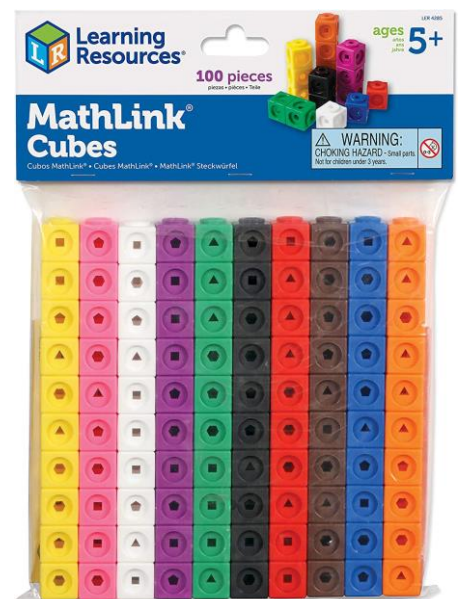

Barn

Total number of cubes

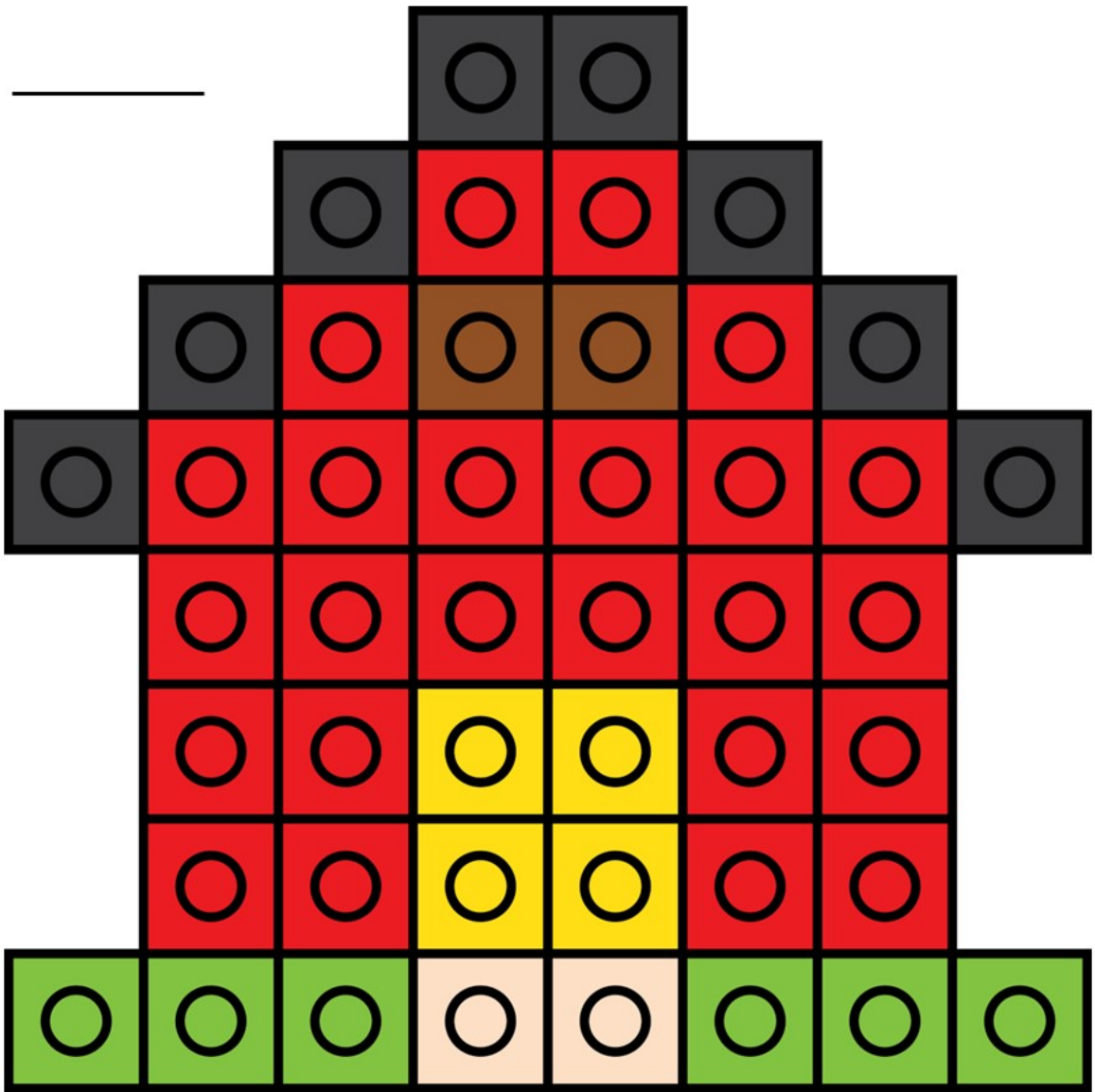

How many cubes are used for the barn?













Chick

Total number of cubes used.

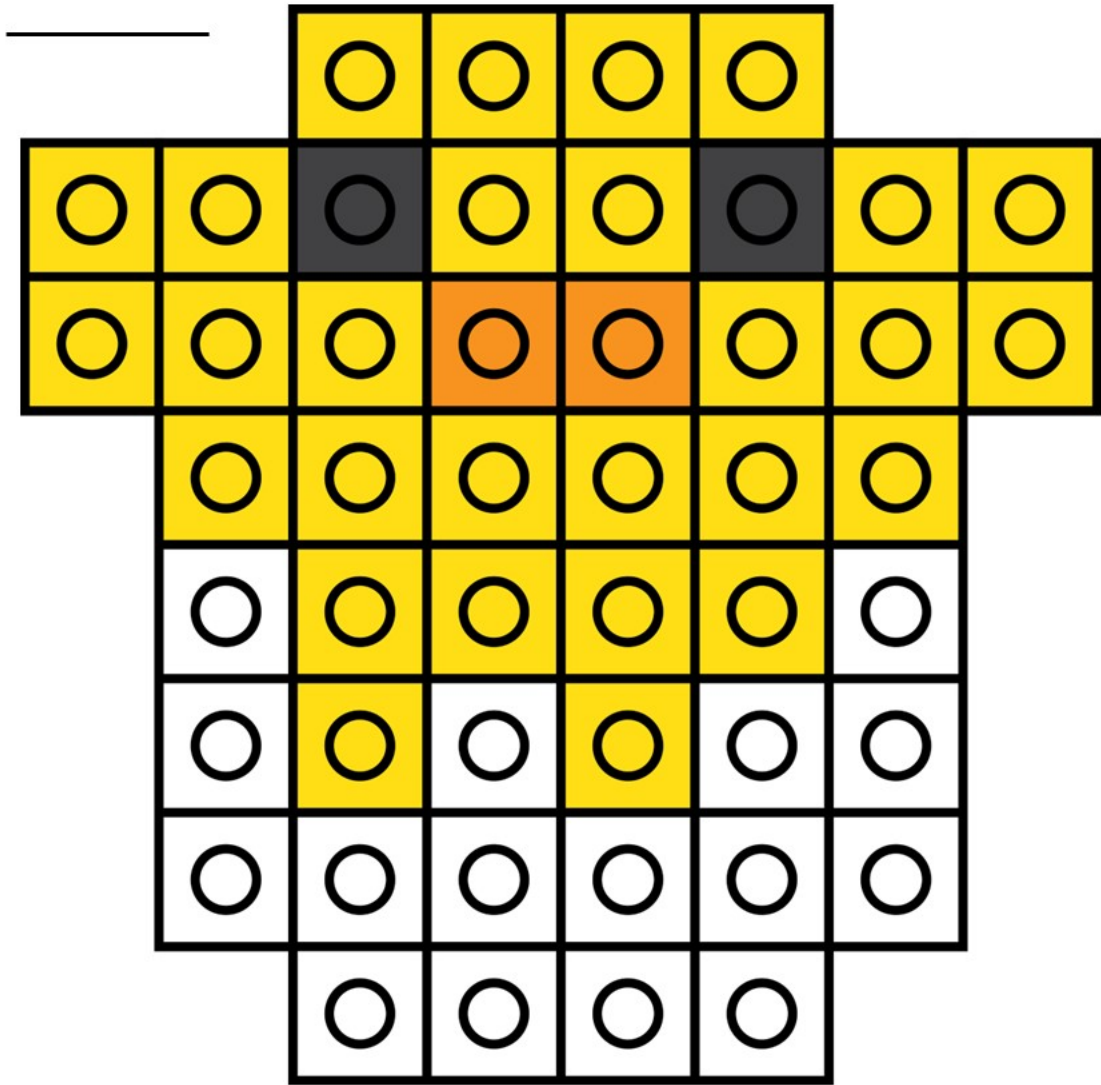

How many cubes are used for the chick?

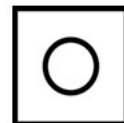

Cow

Total number of cubes used.

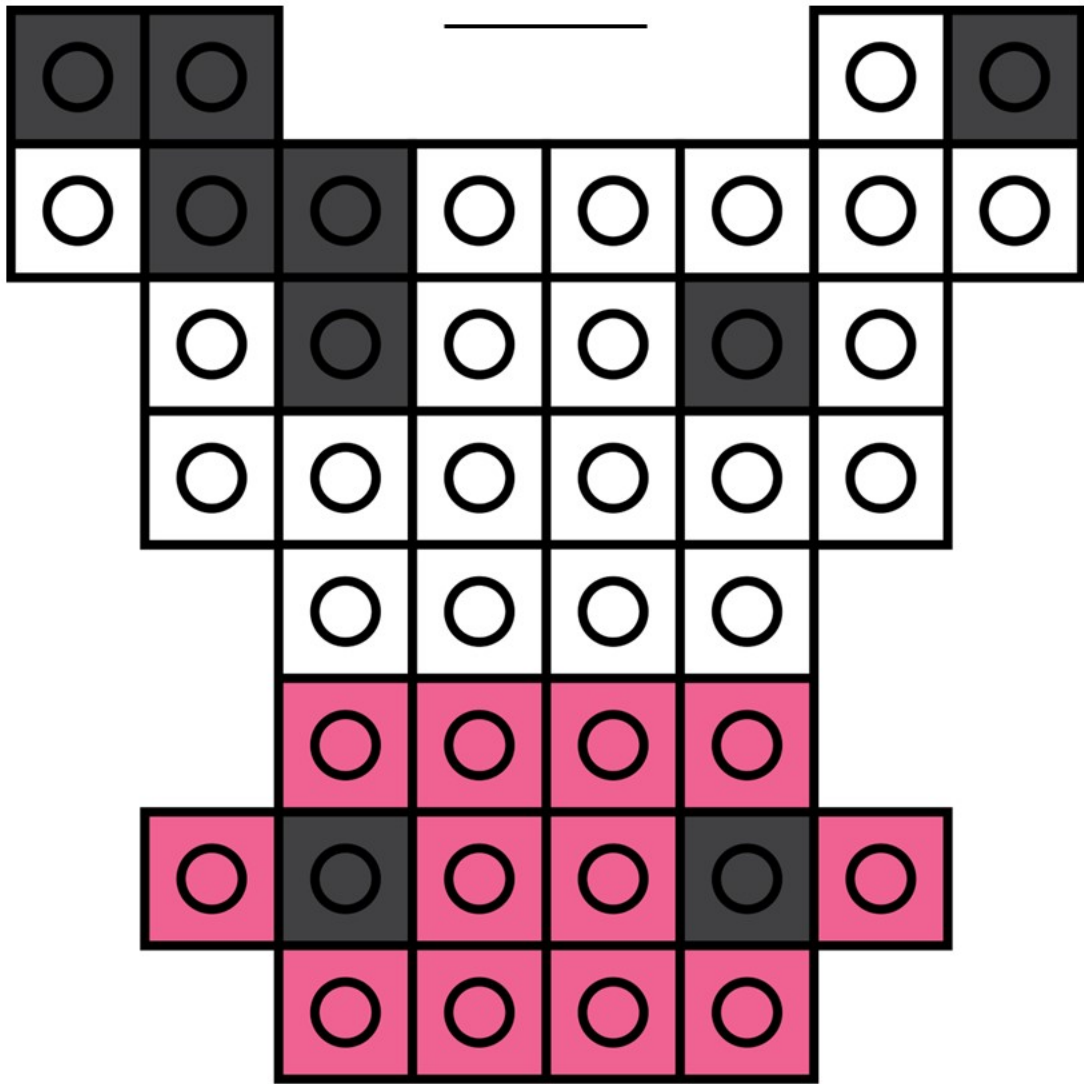

How many cubes are used for the cow?







Haystack

Total number of
cubes used.

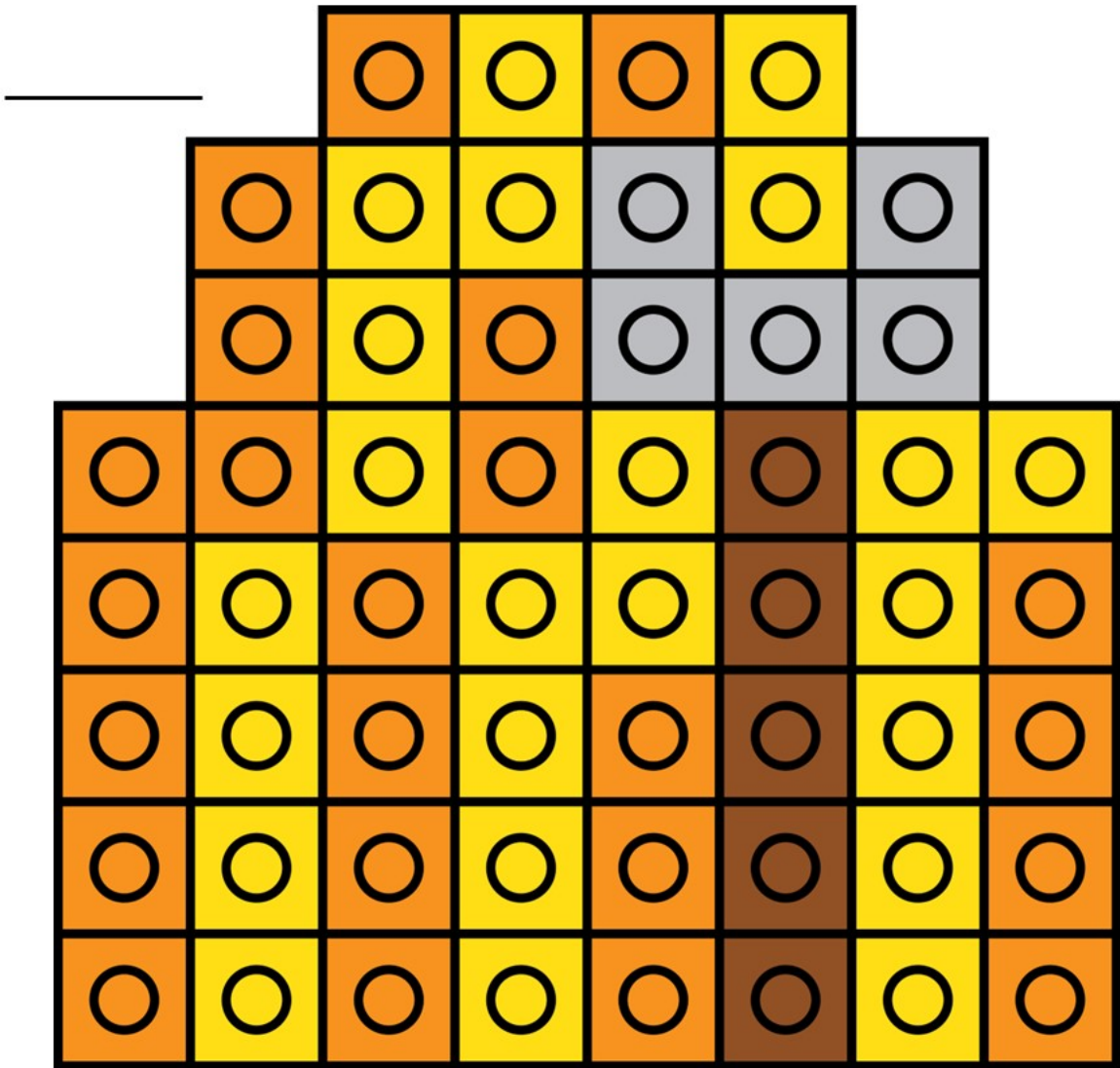

How many cubes are used for the haystack?







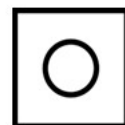

Pig

Total number of cubes used.

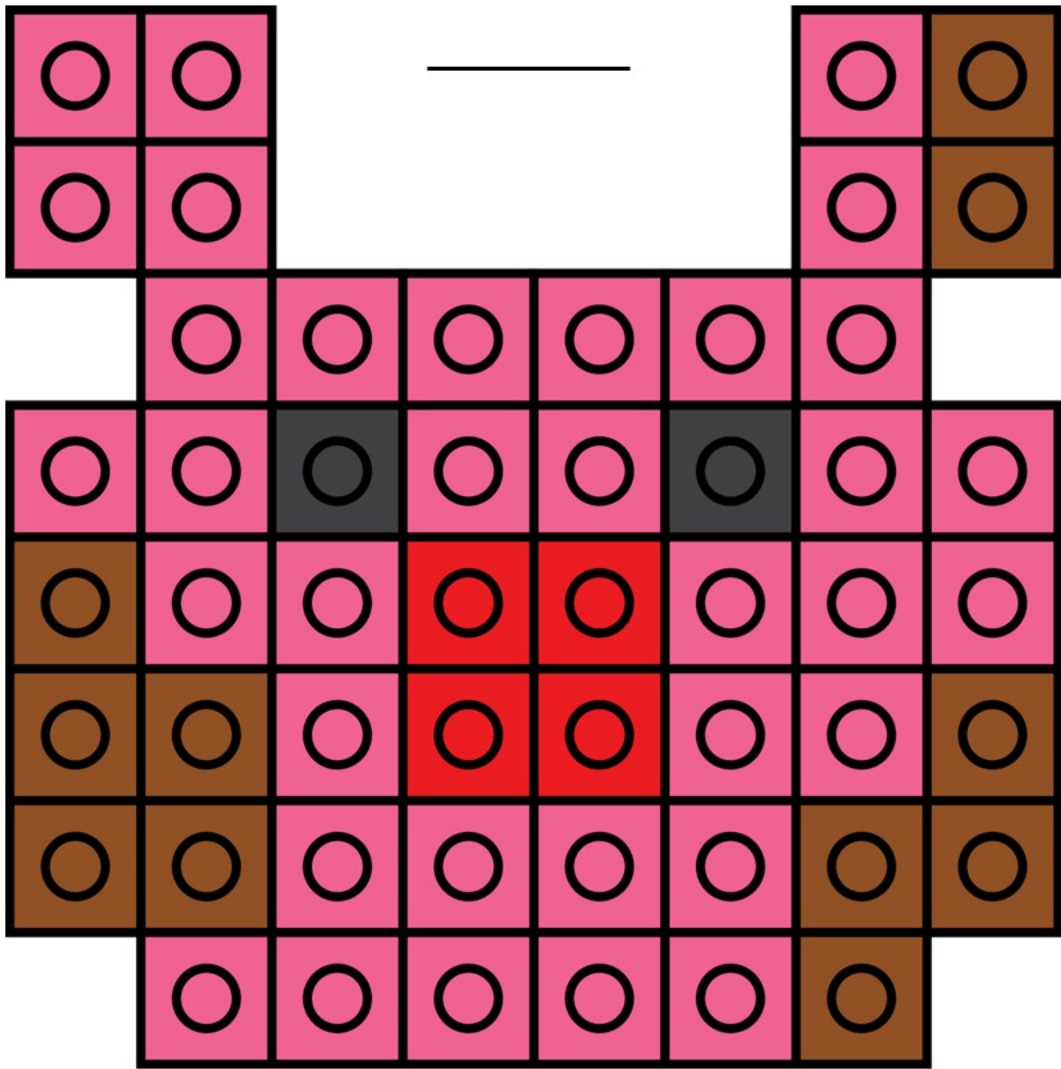

How many cubes are used for the pig?



Scarecrow

Total number of cubes used. _____

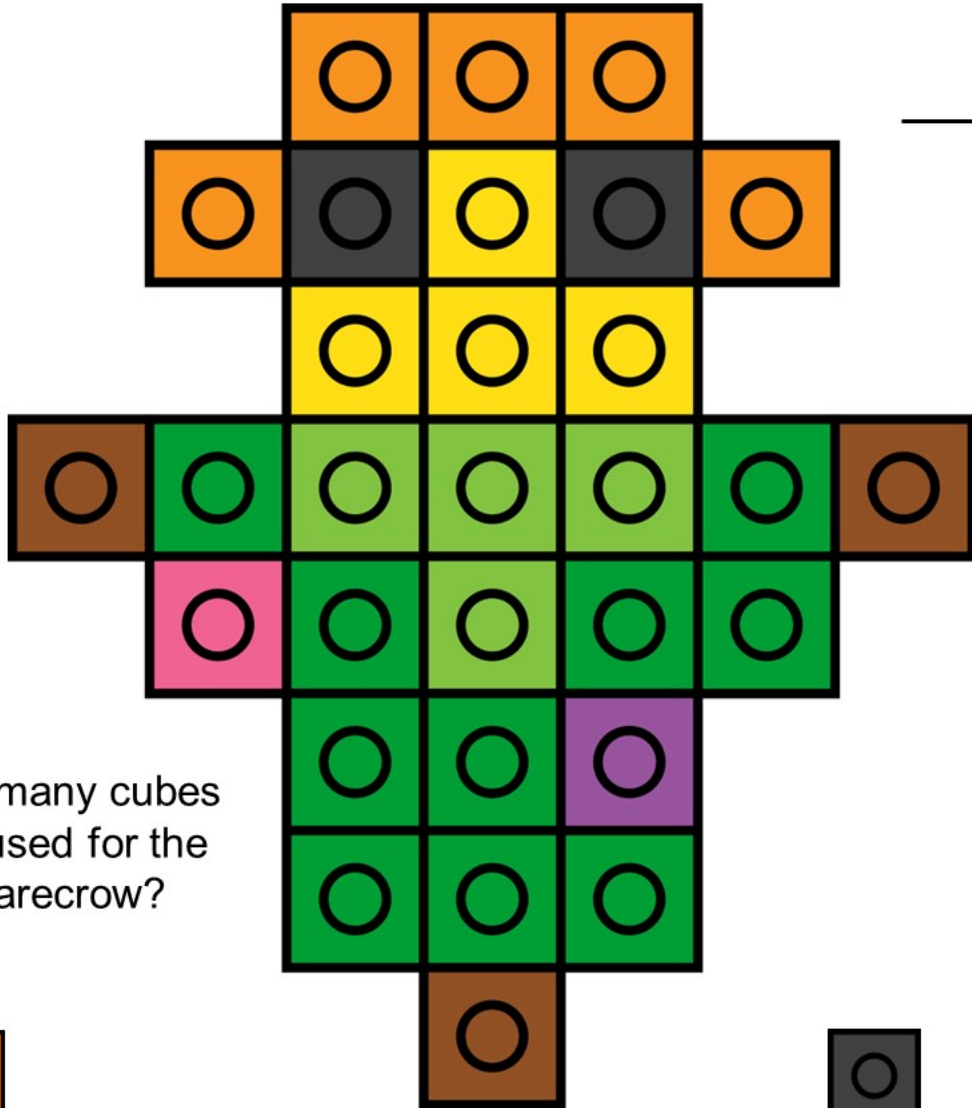

How many cubes are used for the scarecrow?



Sheep

Total number of cubes used. _____

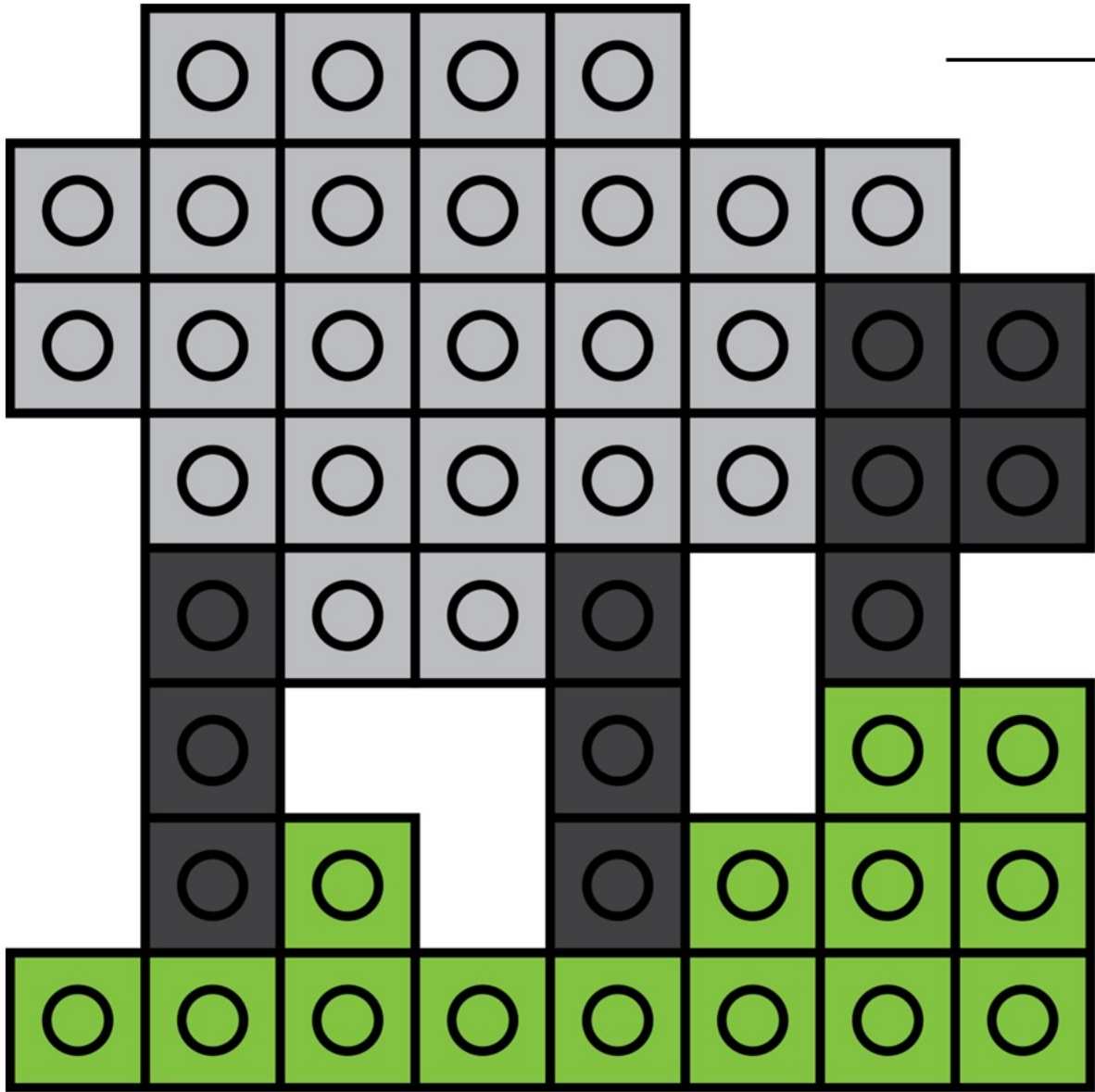

How many cubes are used for the sheep?







Tractor

Total number of cubes used.

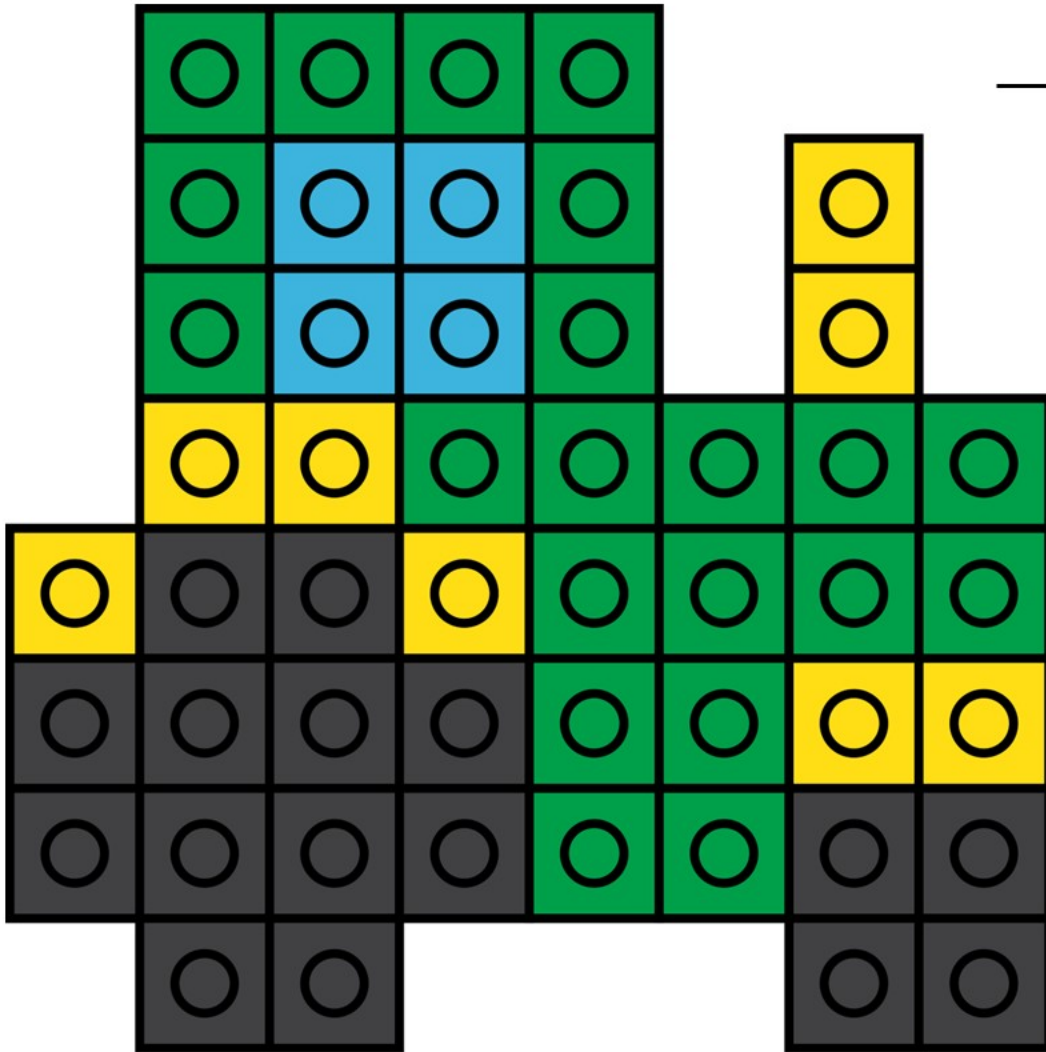

How many cubes are used for the tractor?









Windmill

Total number of cubes used.

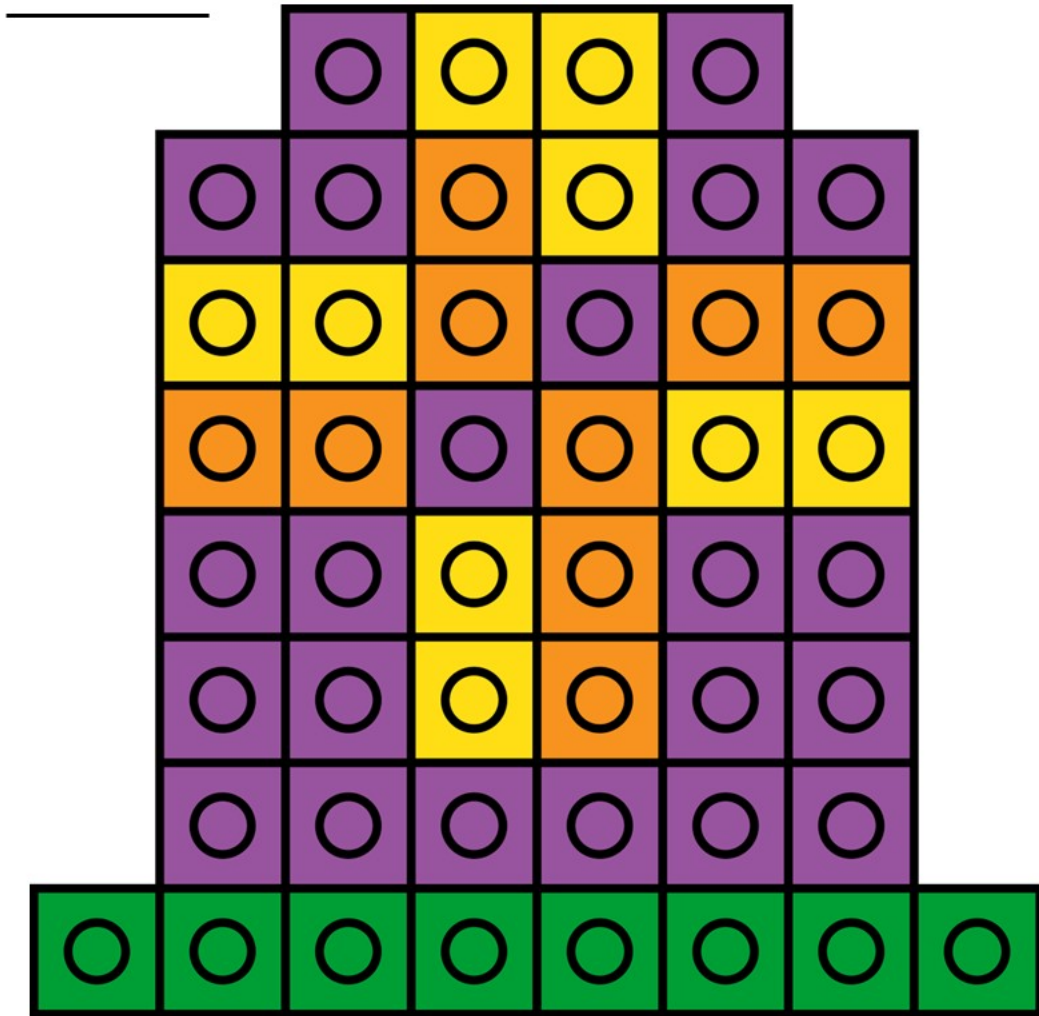

How many cubes are used for the windmill?

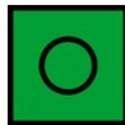

Down on the Farm Cube Pictures

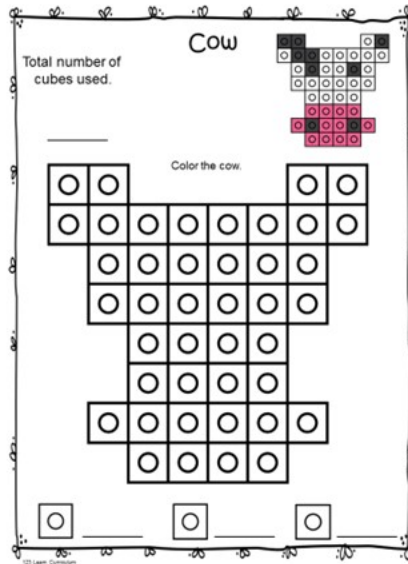
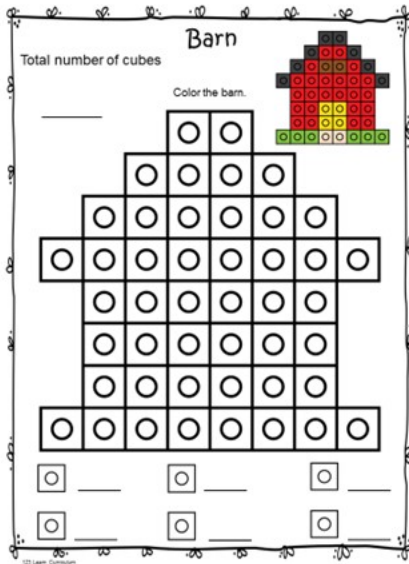

Supplies needed:

- White card stock
- Crayons or markers



Directions:

- Print up Mathlink mats onto white cardstock.
- Have children take a picture and color the squares the same as the colored picture in the corner. Have them count the 1st row and decide how many squares they need to color black. (Using barn picture as a sample). 2nd row - how many squares red and black.
- Once they have the full picture colored, have them use the white squares below to color and then count the number of squares they colored and write the number on the line.

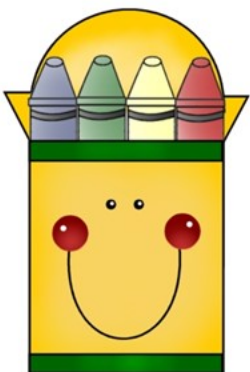

Children will need the correct colors of crayons or markers for each sheet.

Barn

Total number of cubes

Color the barn.

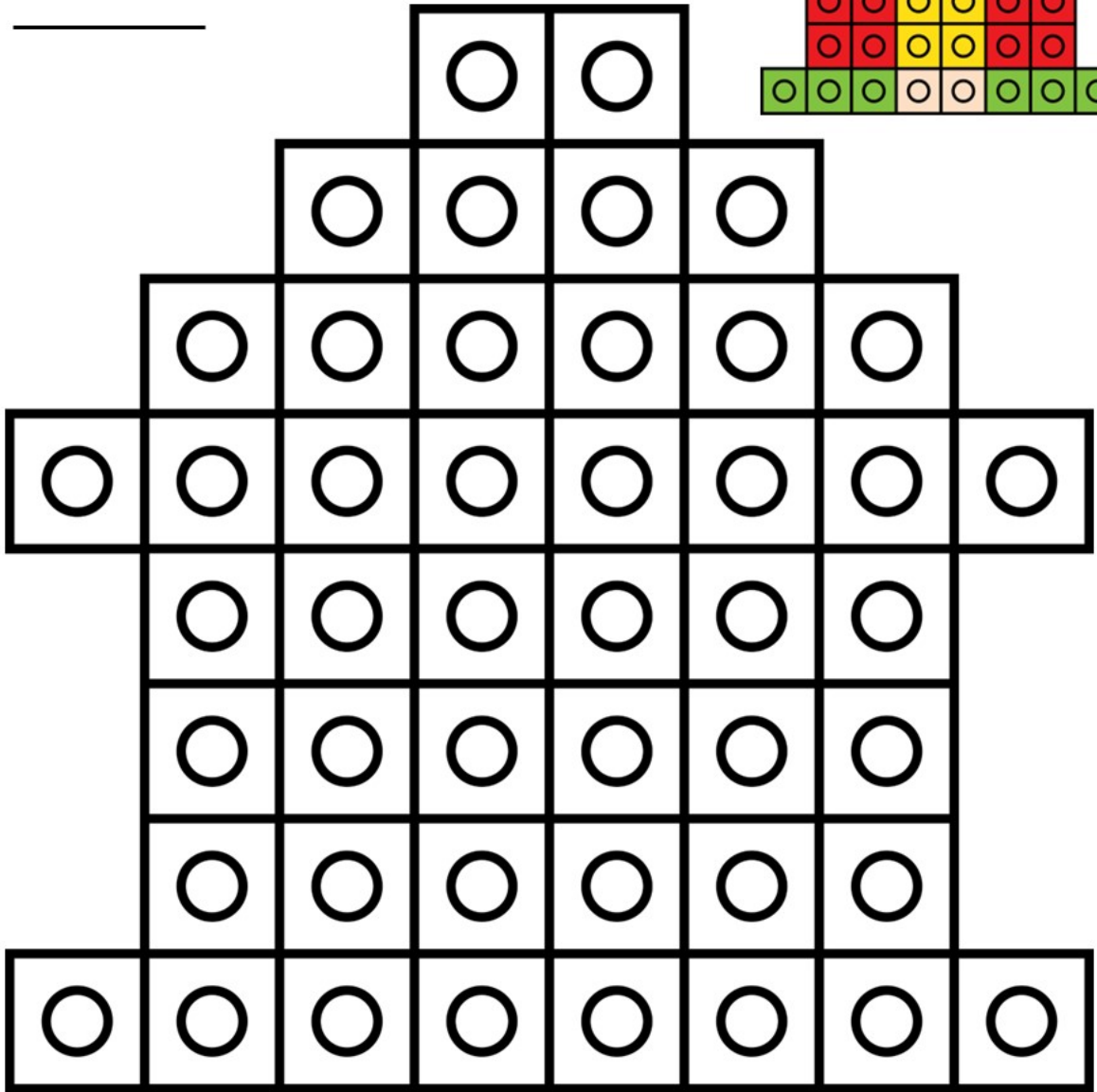
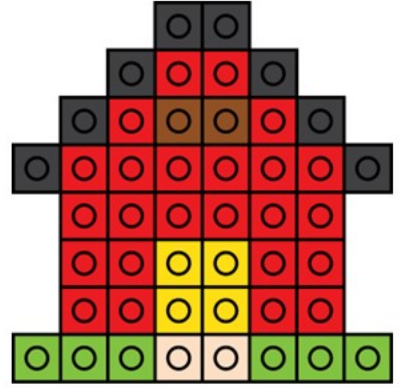

_____ _____ _____

_____ _____ _____

Chick

Total number of cubes used.

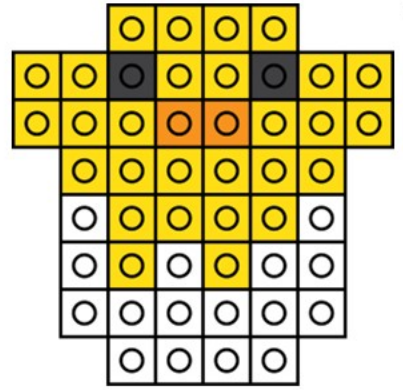

Color the chick.

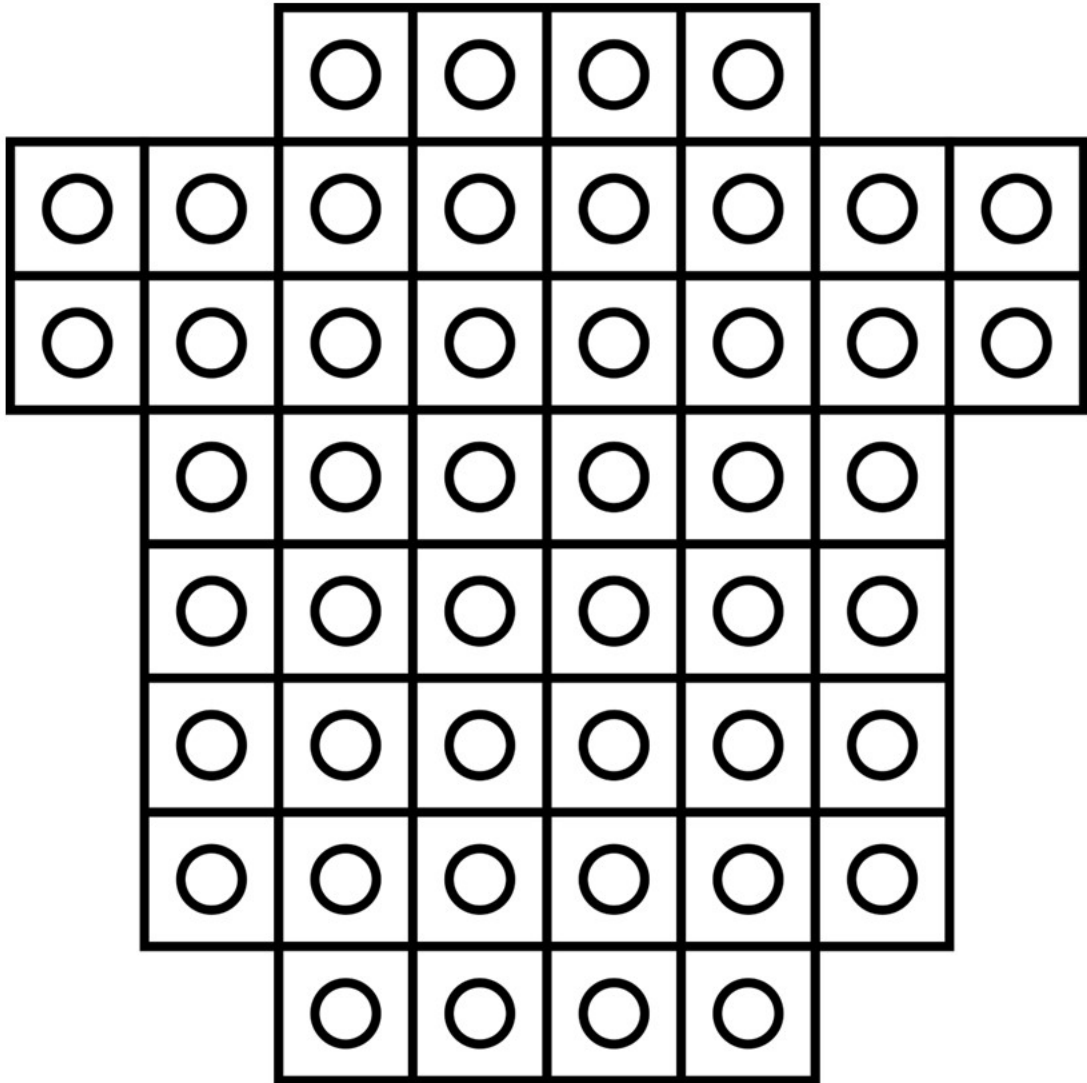







Cow

Total number of cubes used.

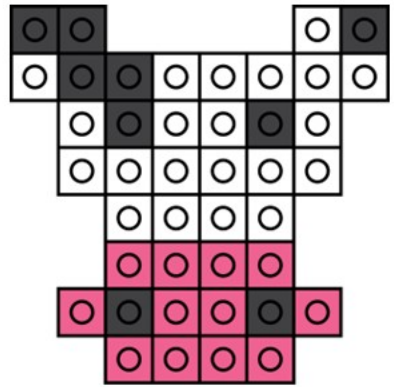

Color the cow.

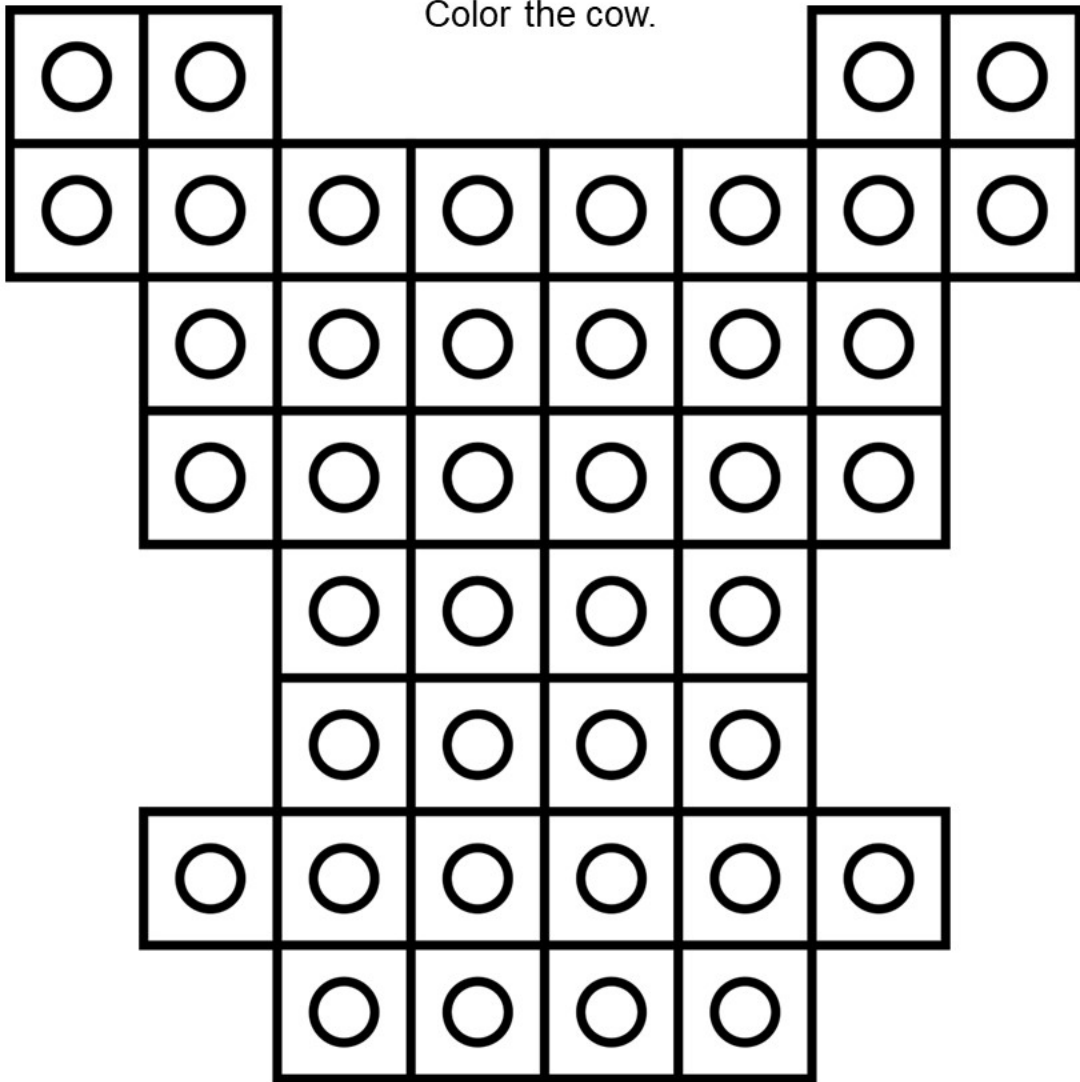





Haystack

Total number of
cubes used.

Color the haystack.

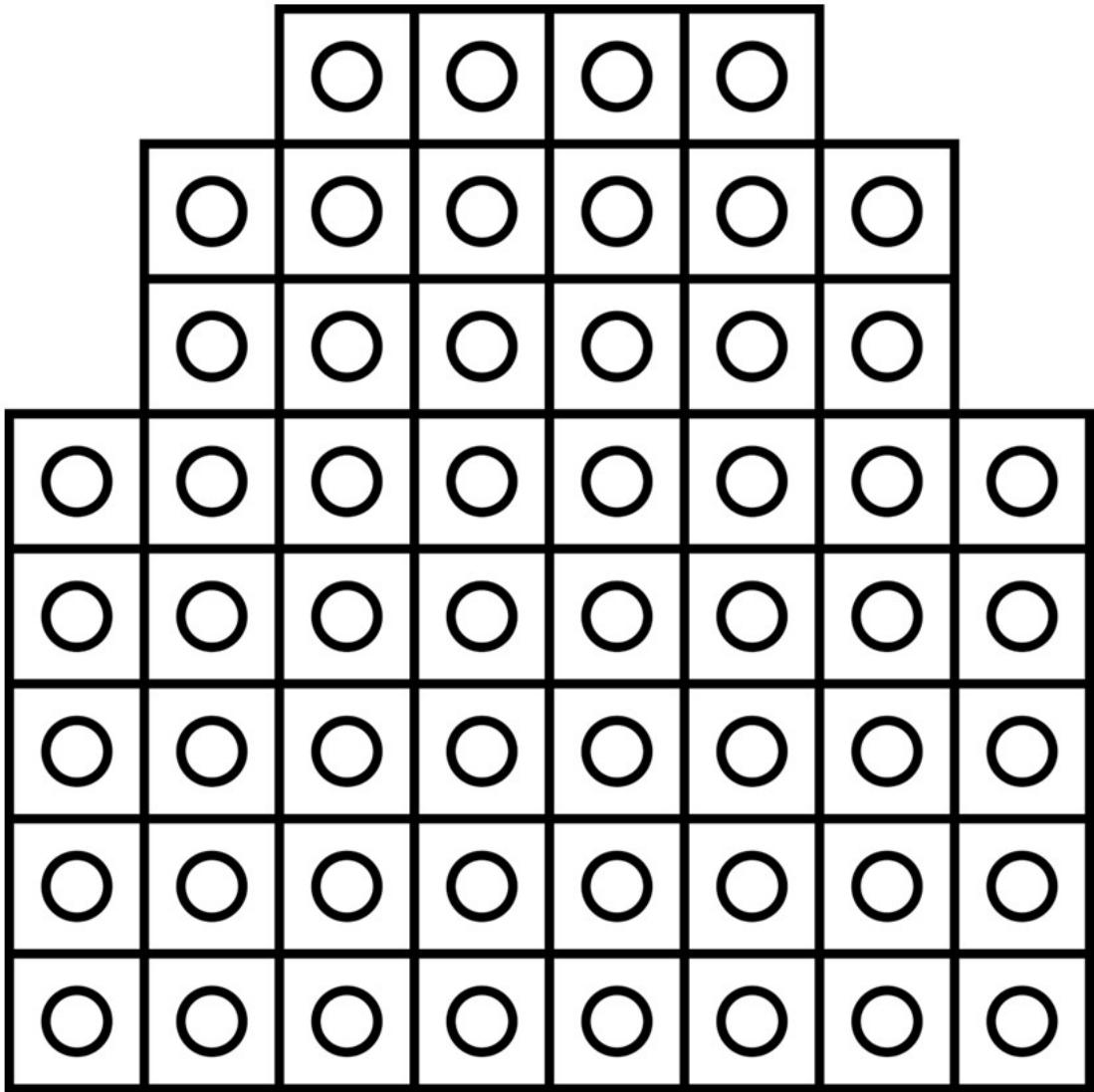
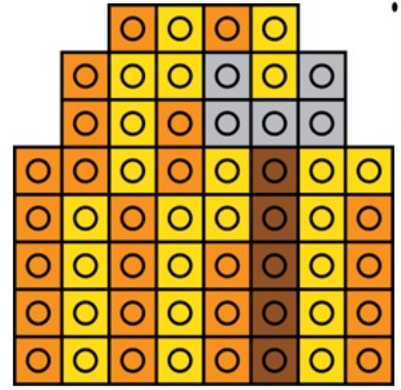







Pig

Total number of
cubes used.

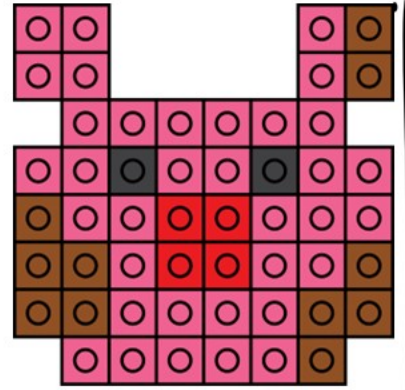

Color the pig

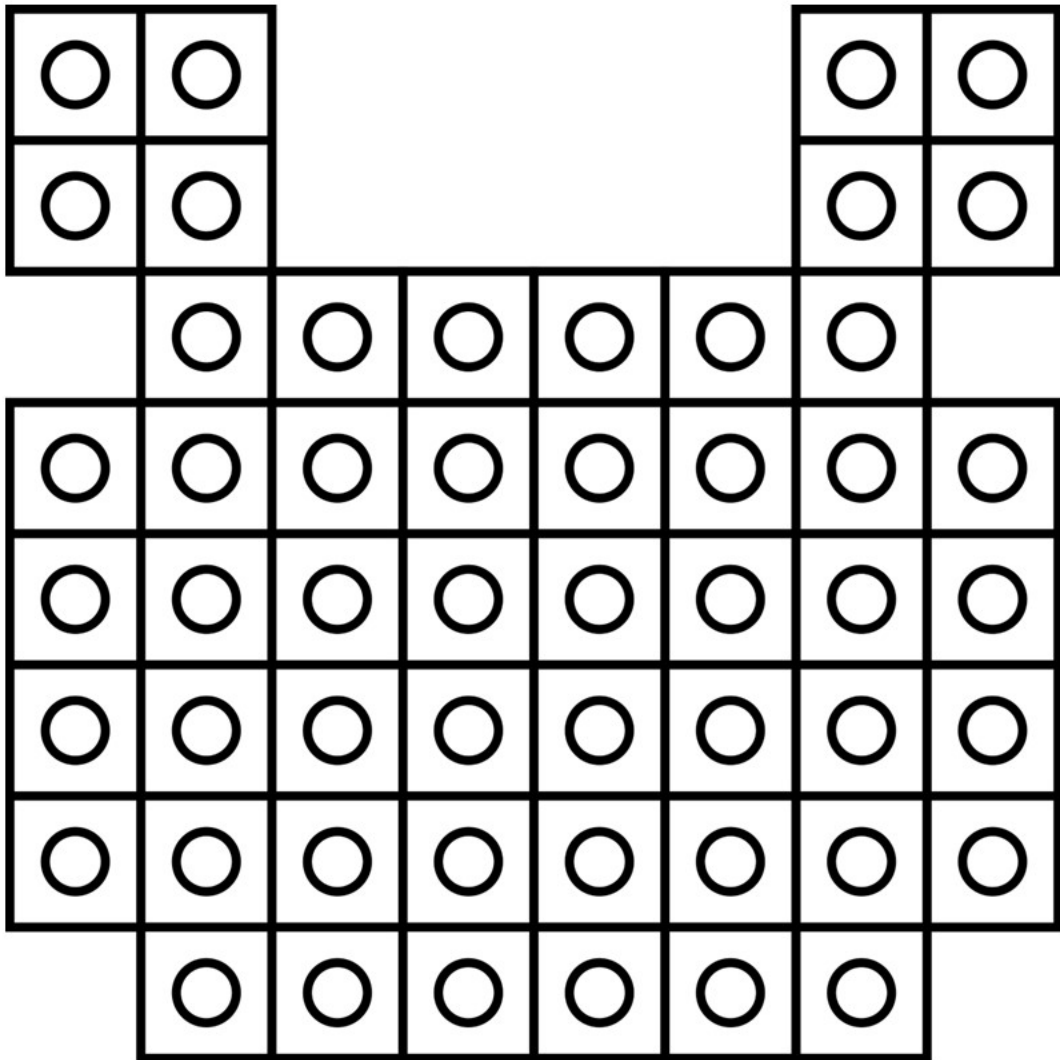







Scarecrow

Total number of
cubes used.

Color the scarecrow.

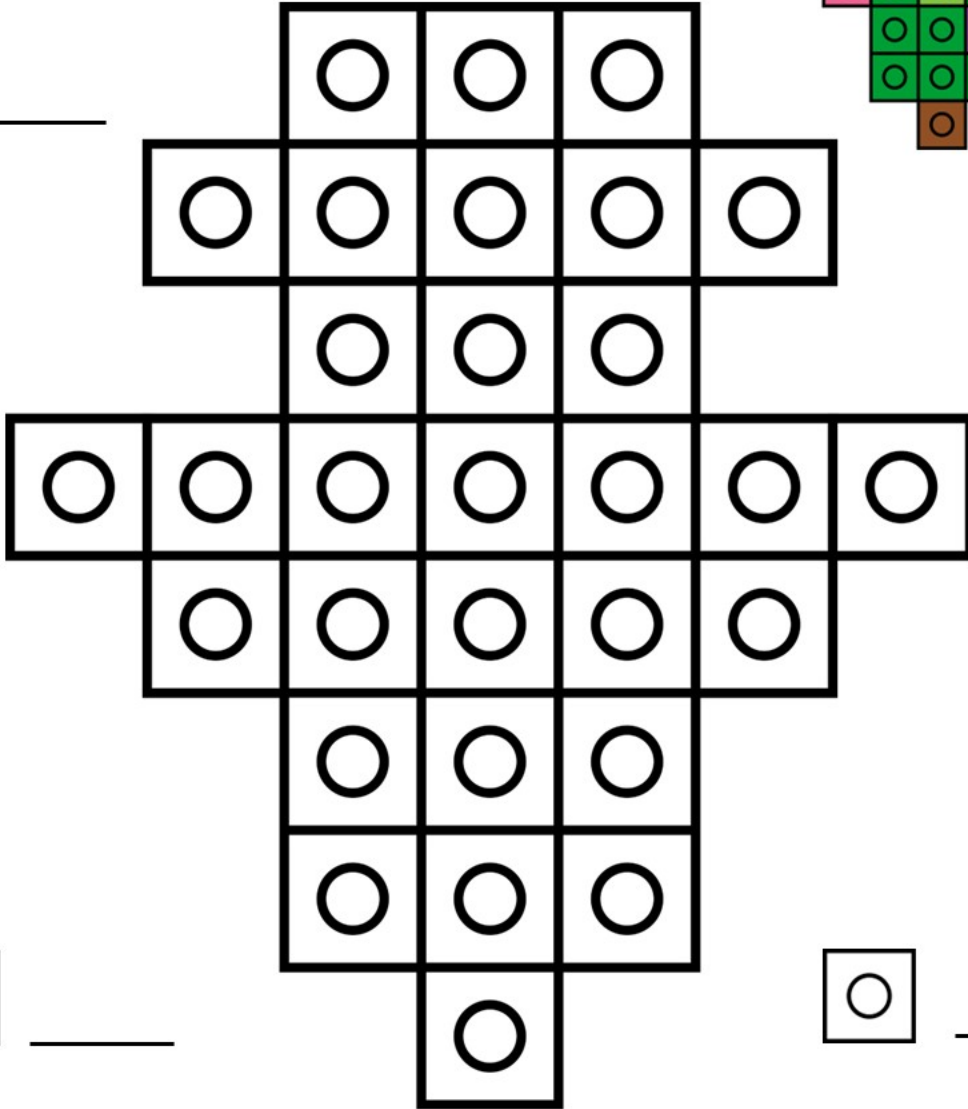
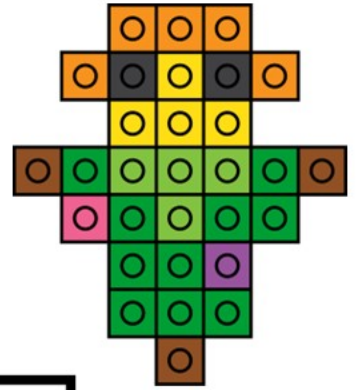

Sheep

Total number of
cubes used.

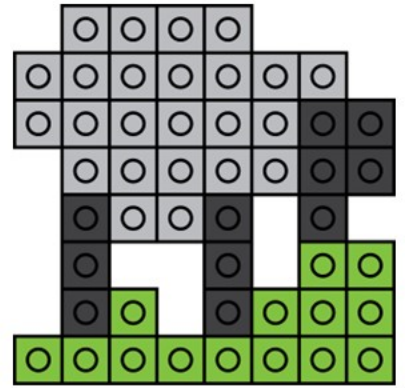

Color the sheep.

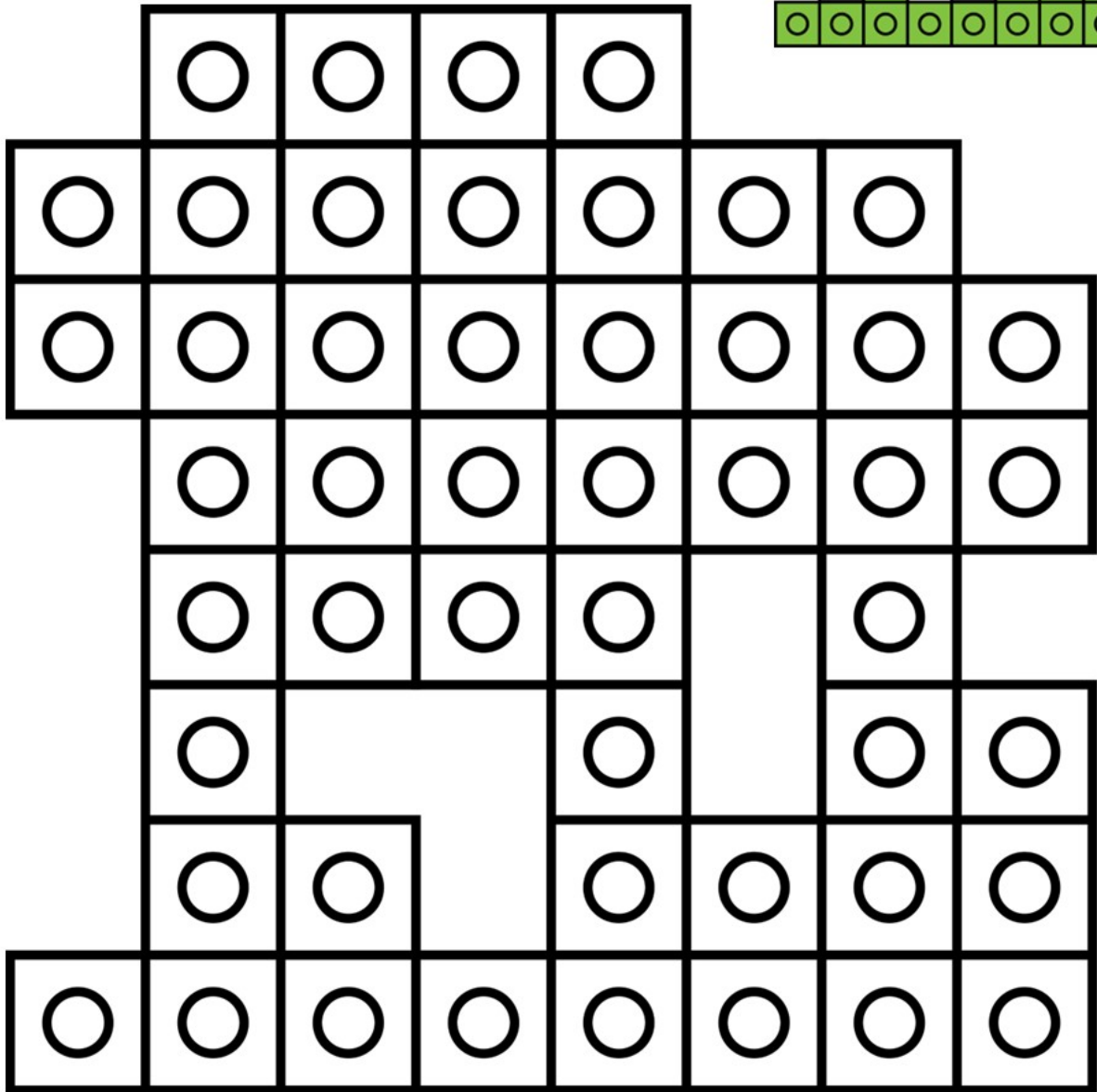





Silo

Total number of
cubes used.

Color the Silo.

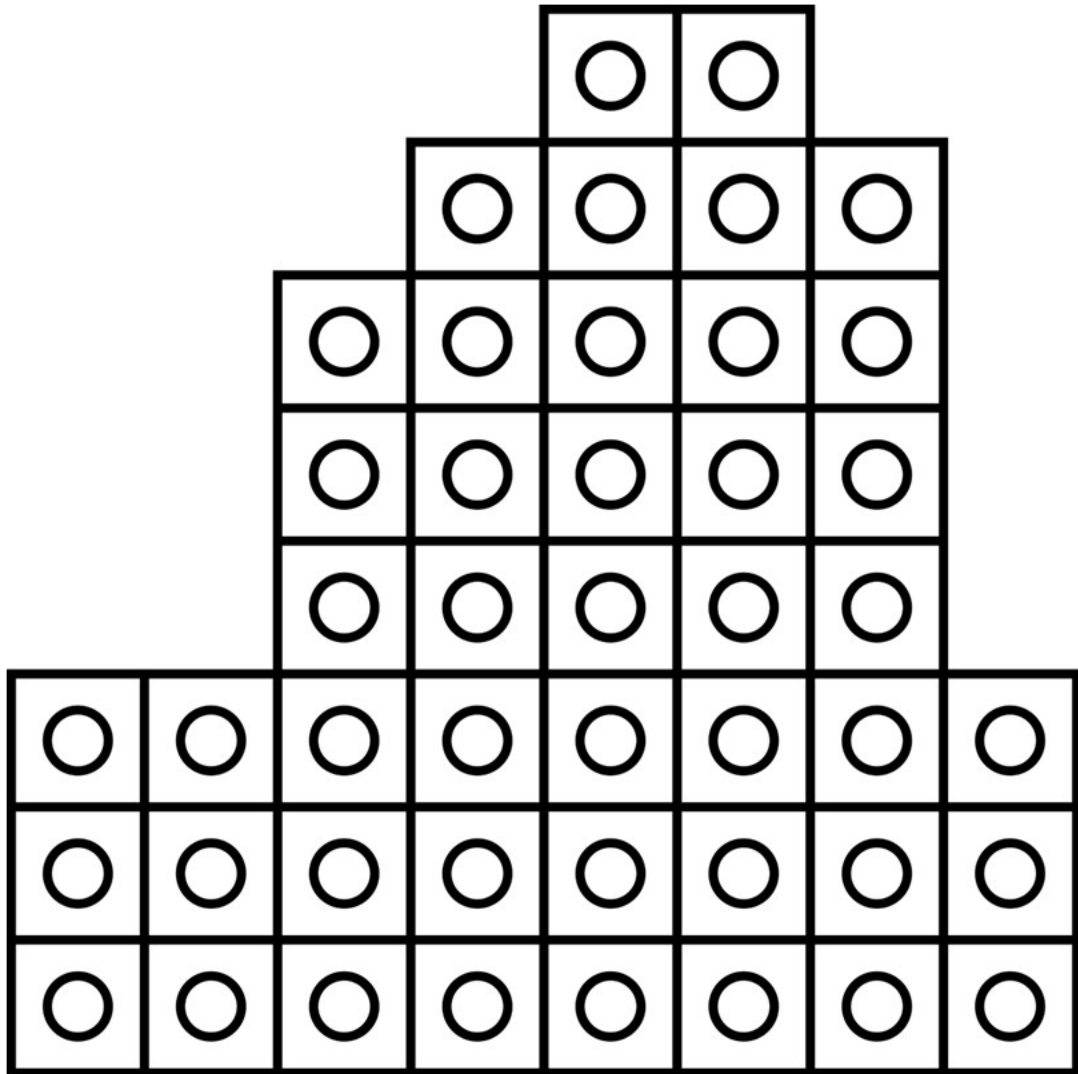
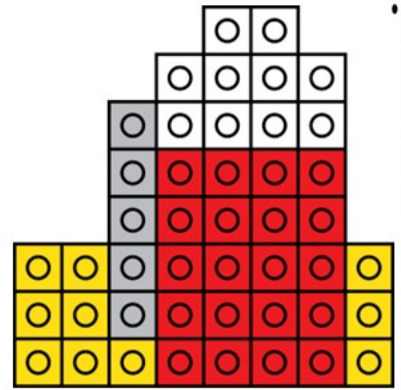





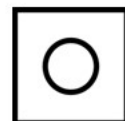

Tractor

Total number of
cubes used.

Color the tractor.

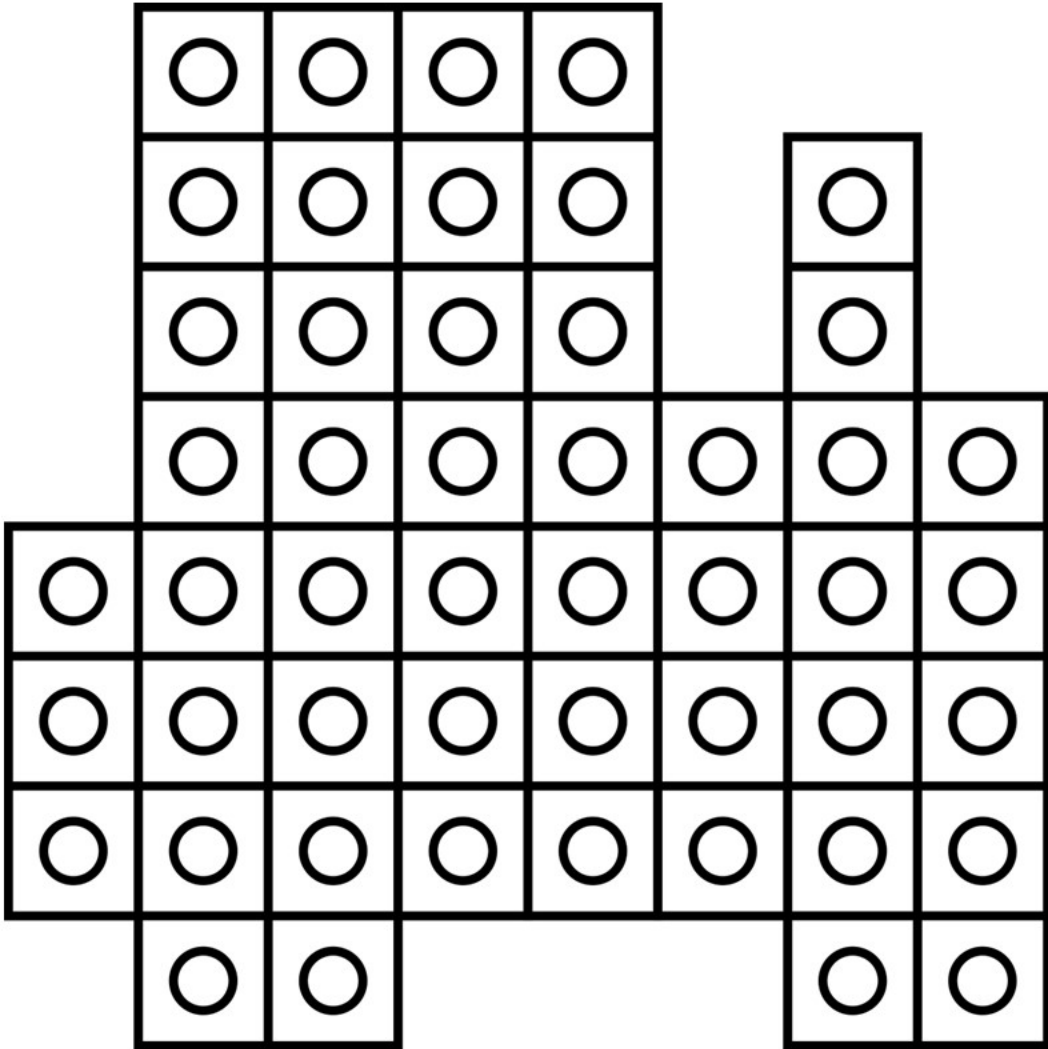
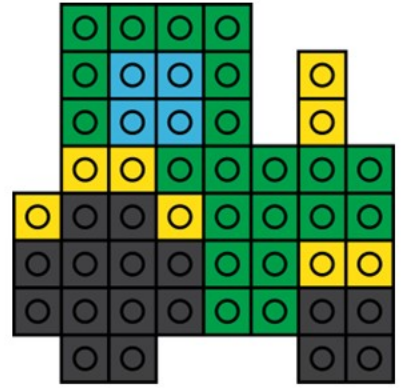





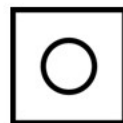

Windmill

Total number of
cubes used.

Color the windmill.

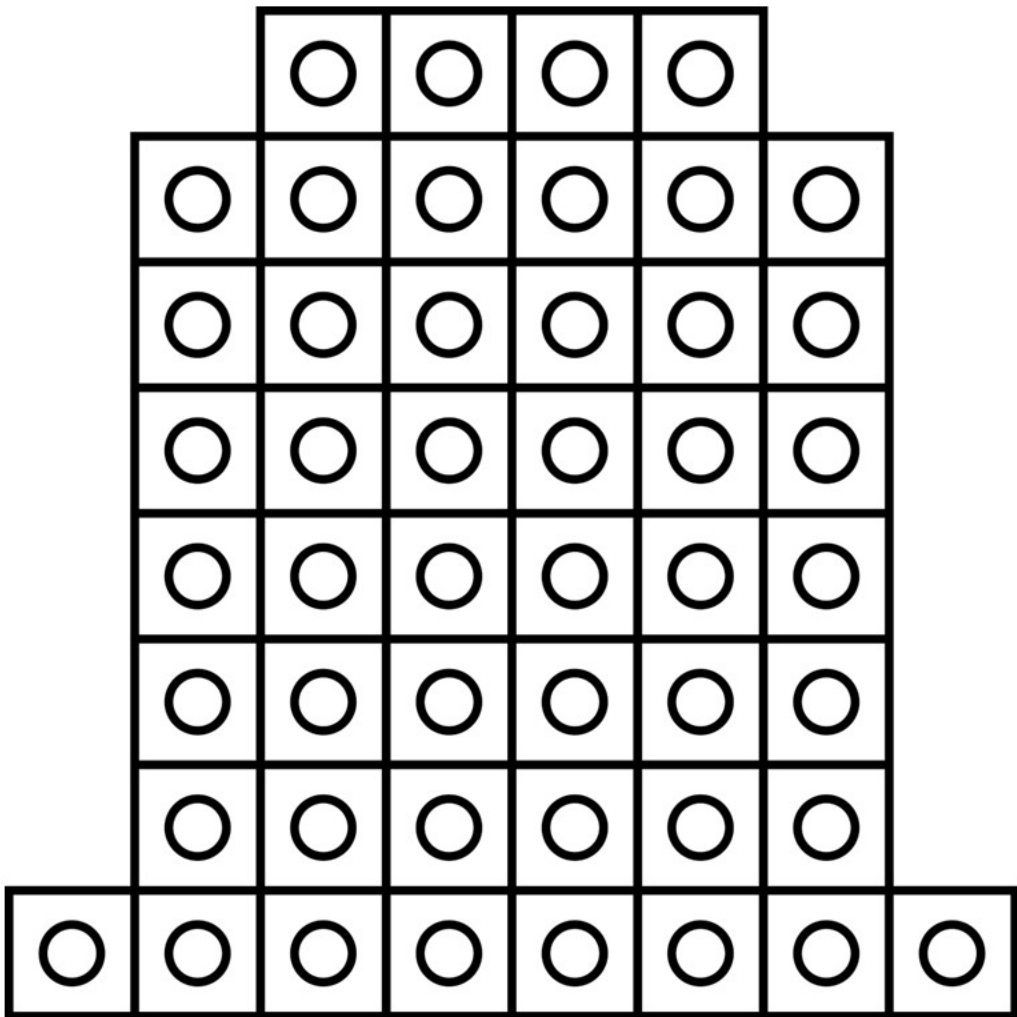
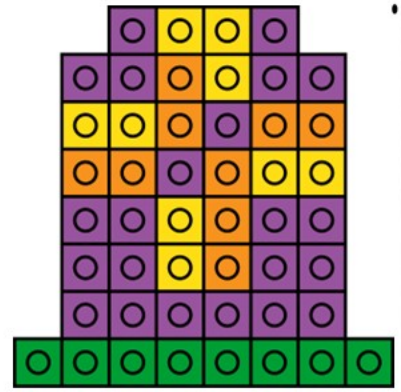



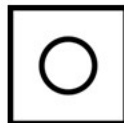



If I Were a Farmer

Print up sheets on regular copy paper.

Have children draw a picture of them being a farmer and write what would be their favorite farm animal. Use vocabulary words for this activity. Have them locate their favorite animal and using the card write the animal on their sheet.

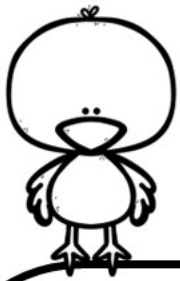

If I Were a Farmer

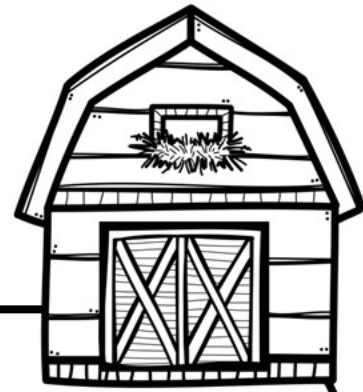

Draw a picture of you being a farmer.....

My favorite farm animal is.....

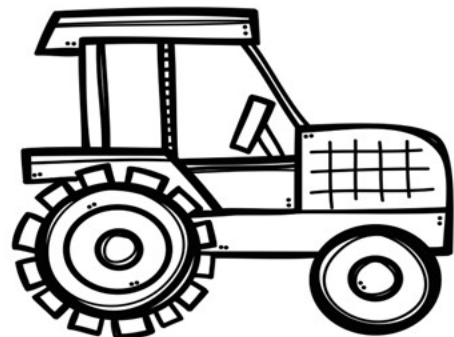

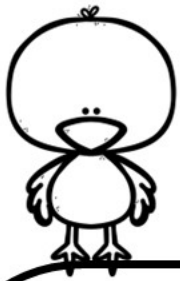

If I Were a Farmer

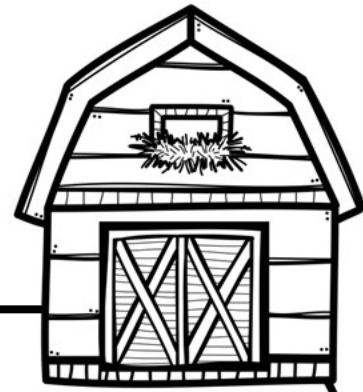

Draw a picture of you being a farmer.....

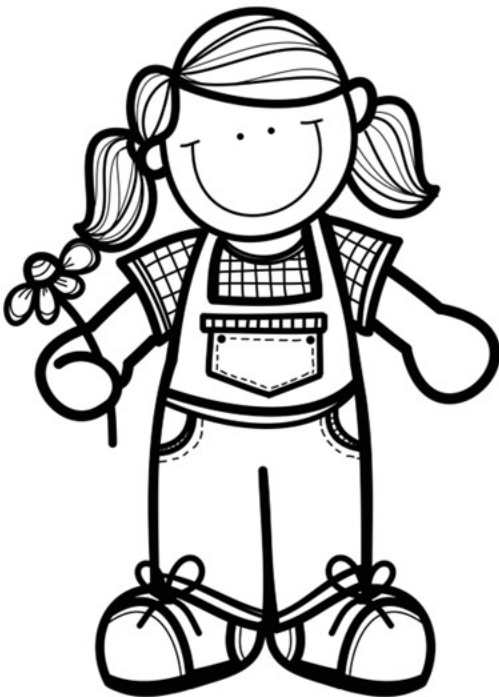

My favorite farm animal is.....

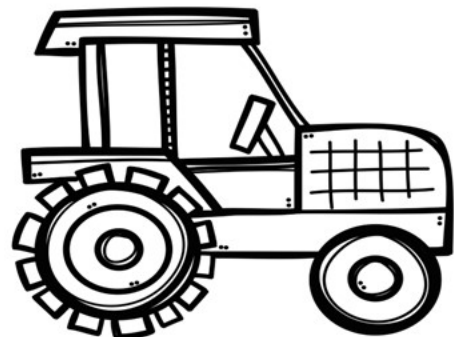

Down on the Farm Vocabulary Words

- Print up on white card stock.
- Laminate.
- Trim.
- Place in writing center. Children can practice writing words on paper or dry eraser board.

Down on the Farm Vocabulary Words



barn



tractor



pig



COW

Down on the Farm Vocabulary Words



horse



chicken



rooster



goose

Down on the Farm Vocabulary Words

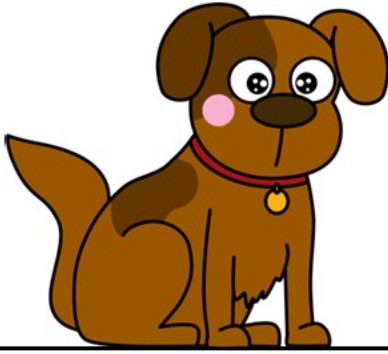

dog



cat



goat



duck

Down on the Farm Vocabulary Words



farmer

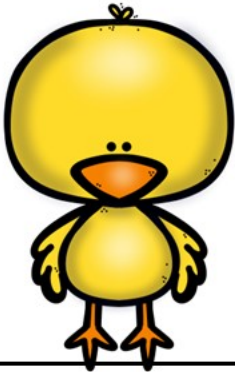

chick



hay



silo

Down on the Farm Vocabulary Words



coop

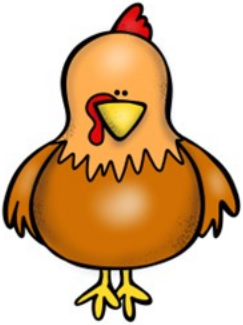

hen



sheep

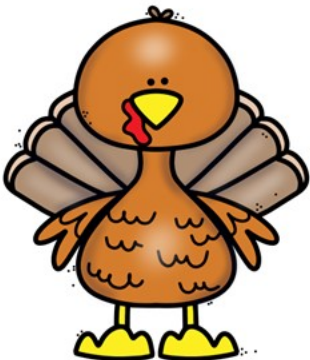

turkey

Down on the Farm Vocabulary Words



vegetables



milk



truck



orchard

Down on the Farm Vocabulary Words



eggs

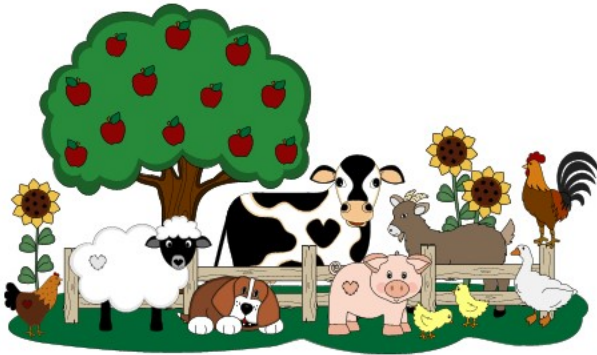

farm



rabbit

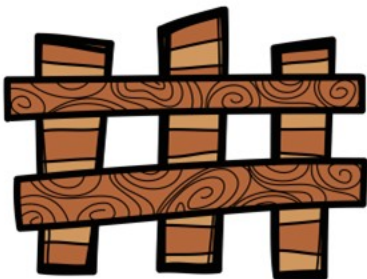

fence

Down on the Farm Vocabulary Words

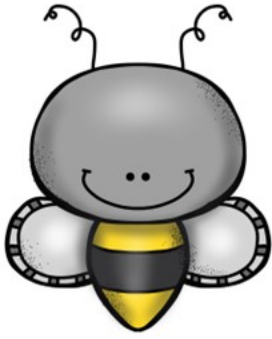

bee



seeds



grain

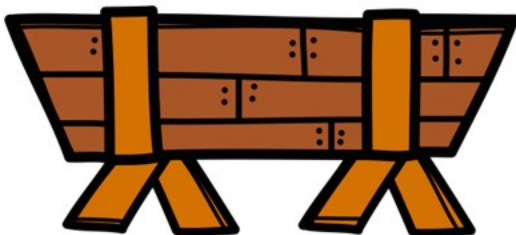

trough

Farm Bingo



Supplies needed:

- White cardstock
- Laminating sheets
- Scissors
- Bingo game markers (M&M's skittles, dry beans, etc.)



Directions:

Print bingo cards and calling cards onto white cardstock.

Laminate all pages.

Cut bingo cards in half.

Cut out all 35 calling cards out.

Place bingo cards into a bag.

Have children pick a bingo card out and place in front of them.

Pass out bingo card markers and have everyone place a game marker on the free space.



Decide on what bingo game you are going to play. (Pictures included)
 Draw a game piece from the bag, read the card and show the children the picture. Have them place a game marker on the matching picture if they have it.
 Place the calling card onto the game card sheet to keep track of the pictures called.
 When children have a bingo, have them call out bingo.

* Print up the bingo game cards you can play onto white card stock, laminate, cut in half and hang up the game you're going to play as a visual for the children.

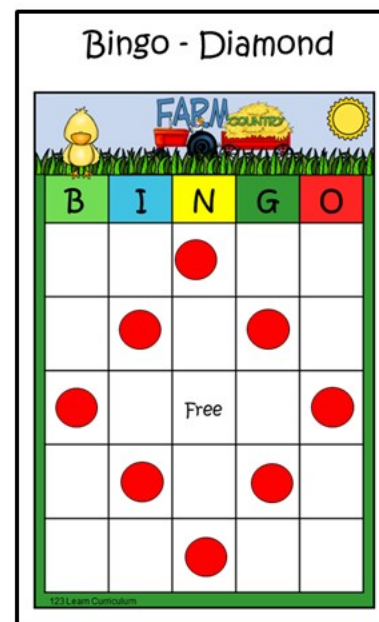
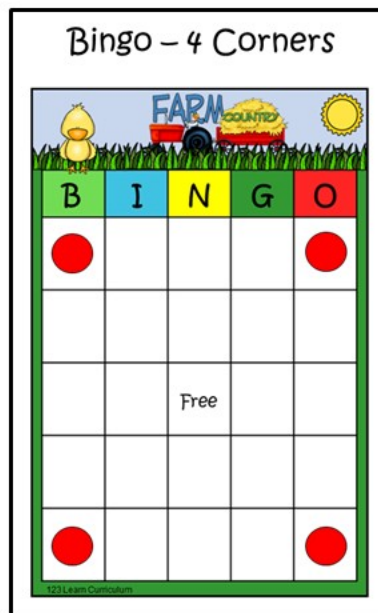
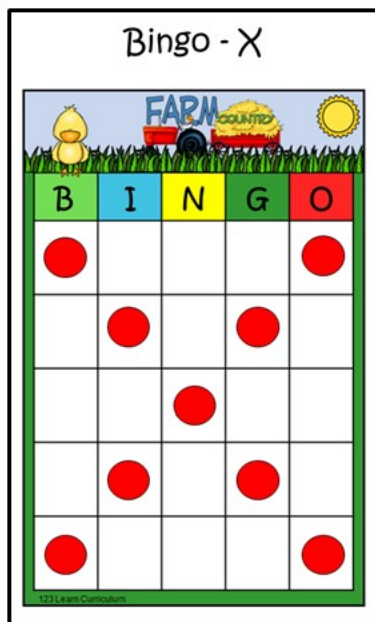

Bingo - X

A farm-themed bingo card with a 5x5 grid. The top header features a yellow chick, a red tractor pulling a hay wagon, and a sun. The word "FARM" is written in blue and "COUNTRY" in green. The grid has a green border and a green header row with the letters B, I, N, G, O. A diagonal line of red circles is drawn from the top-left to the bottom-right.

B	I	N	G	O
●				●
	●		●	
		●		
	●		●	
●				●

123 Learn Curriculum

Bingo - 4 Corners

A farm-themed bingo card with a 5x5 grid. The top header features a yellow chick, a red tractor pulling a hay wagon, and a sun. The word "FARM" is written in blue and "COUNTRY" in green. The grid has a green border and a green header row with the letters B, I, N, G, O. Red circles are placed at the four corners of the grid.

B	I	N	G	O
●				●
		Free		
●				●

123 Learn Curriculum

Bingo - Diamond



B	I	N	G	O
		●		
	●		●	
●		Free		●
	●		●	
		●		

123 Learn Curriculum

Bingo - Letter H



B	I	N	G	O
●				●
●				●
●	●	●	●	●
●				●
●				●

123 Learn Curriculum

Bingo - Plus

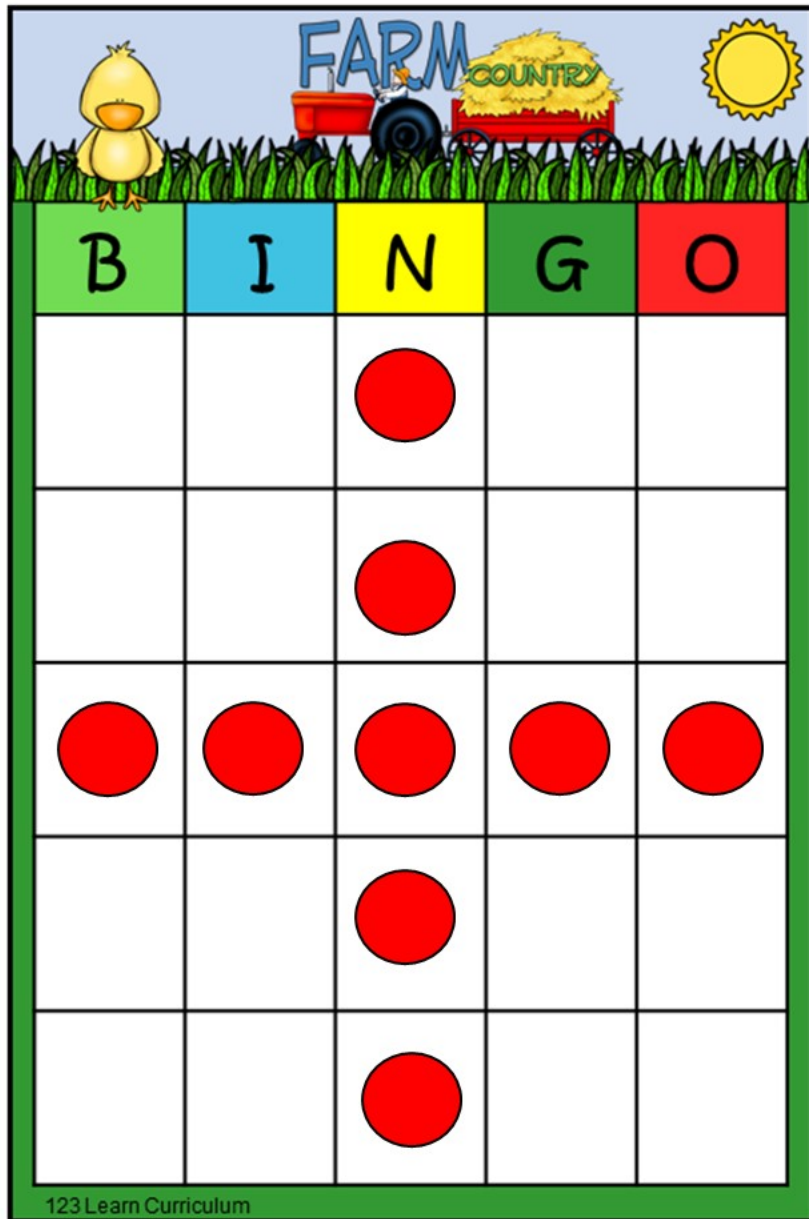

A 5x5 bingo grid with a farm-themed header. The header includes a yellow chick, a red tractor pulling a hay wagon, and a sun. The words 'FARM' and 'COUNTRY' are written in blue and green respectively. The grid has a green border. The letters B, I, N, G, O are in the top row, each in a different colored box: B (green), I (blue), N (yellow), G (green), O (red). The grid contains red circles in the following positions: (1,3), (2,3), (3,1), (3,2), (3,3), (3,4), (3,5), (4,3), (5,3).

B	I	N	G	O
		●		
		●		
●	●	●	●	●
		●		
		●		

123 Learn Curriculum

Bingo - Square

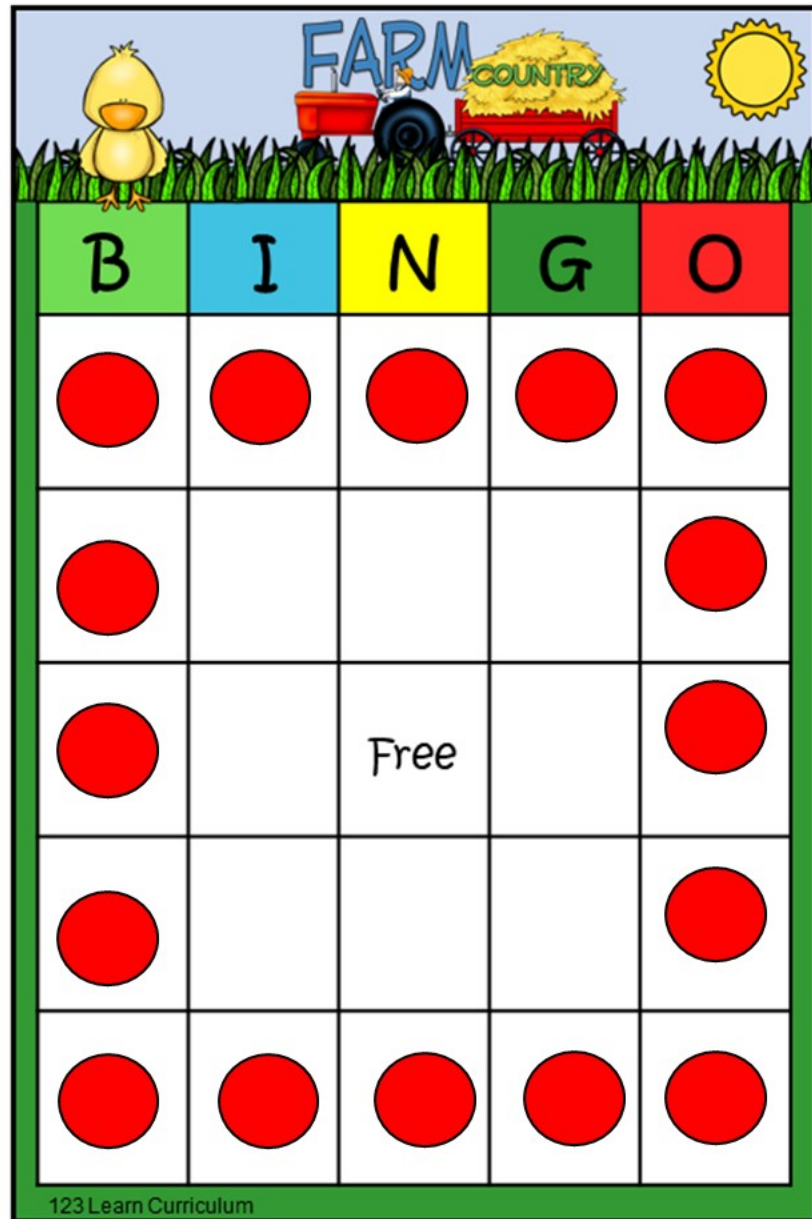

A 5x5 bingo grid with a farm-themed header. The header includes a yellow chick, a red tractor pulling a hay wagon, and a sun. The words 'FARM' and 'COUNTRY' are written in blue and green respectively. The grid has a green border. The letters B, I, N, G, O are in the top row, each in a different colored box: B (green), I (blue), N (yellow), G (green), O (red). The grid contains red circles in the following positions: (1,1), (1,2), (1,3), (1,4), (1,5), (2,1), (2,5), (3,1), (3,5), (4,1), (4,5), (5,1), (5,2), (5,3), (5,4), (5,5). The center cell (3,3) is labeled 'Free'.

B	I	N	G	O
●	●	●	●	●
●				●
●		Free		●
●				●
●	●	●	●	●

123 Learn Curriculum

Bingo - Letter T

B	I	N	G	O
●	●	●	●	●
		●		
		●		
		●		
		●		





Bingo - Cover All

B	I	N	G	O
●	●	●	●	●
●	●	●	●	●
●	●	●	●	●
●	●	●	●	●
●	●	●	●	●



B	I	N	G	O
				
				
		Free		
				
				



B	I	N	G	O
				
				
		Free		
				
				



B

I

N

G

O

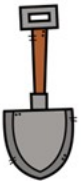

Free

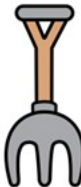

B

I

N

G

O

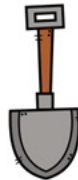

Free

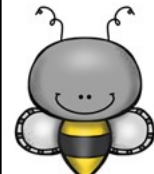
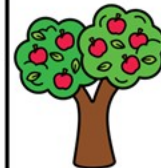



B I N G O

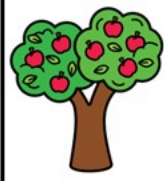

Free

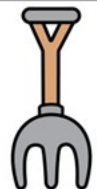

B I N G O

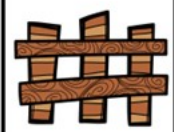
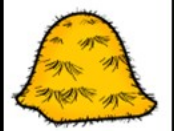
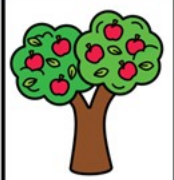
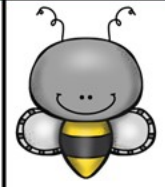

Free

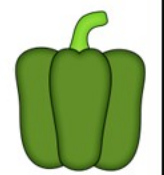
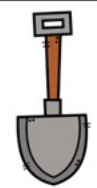

FARM COUNTRY



B	I	N	G	O
		Free		

FARM COUNTRY



B	I	N	G	O
		Free		

FARM COUNTRY



B I N G O

		Free		

FARM COUNTRY



B I N G O

		Free		



B I N G O

				
				
		Free		
				
				



B I N G O

				
				
		Free		
				
				



B I N G O

				
				
		Free		
				
				



B I N G O

				
				
		Free		
				
				



B I N G O

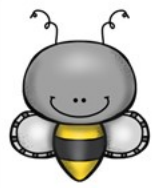
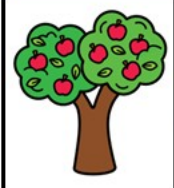

Free

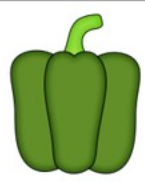
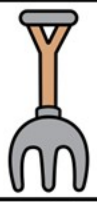

B I N G O

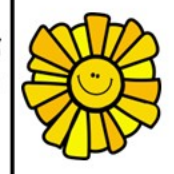

Free

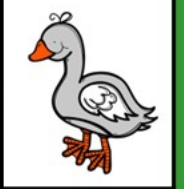
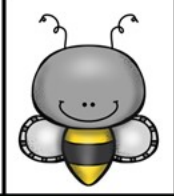
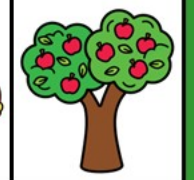
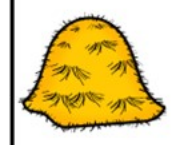
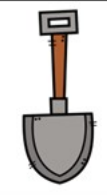
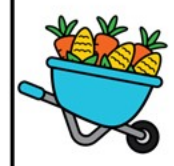



B I N G O

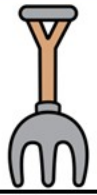
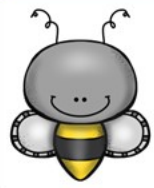

Free

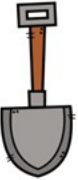

B I N G O

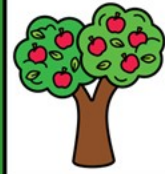

Free

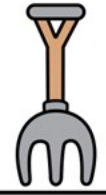

FARM COUNTRY



B	I	N	G	O
		Free		

FARM COUNTRY



B	I	N	G	O
		Free		



Barn



Chicken



Cow



Seeds



Sun



Duck



Rooster



Silo



Pig



Corn



Carrot



Farmer



Tractor



Apple Tree



Sheep



Green Pepper



Hay



Grain



Goose



Goat



Warm



Cat



Mouse



Dog



Watermelon



Hen



Wheelbarrow



Scarecrow

Calling cards

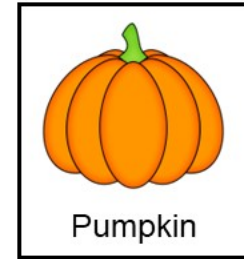
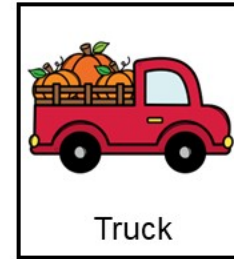
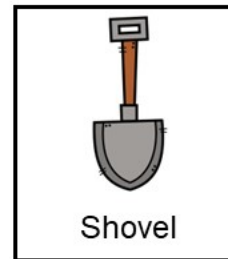
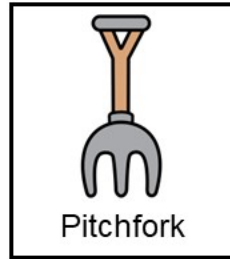
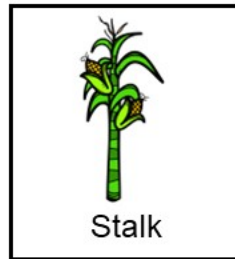
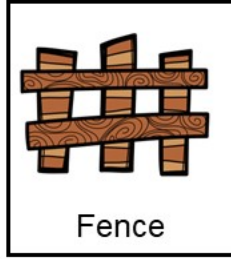
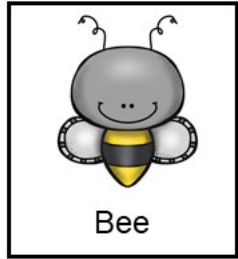

Calling cards

- Print up calling cards onto white card stock.
- Laminate
- Cut out
- Place cards in a bag and draw the cards out of the bag.

Farm Q-Tips Painting

- Print up sheets on white card stock.
- Have small containers of paint available for children and let them paint pictures using Q-Tips and paint.

Barn

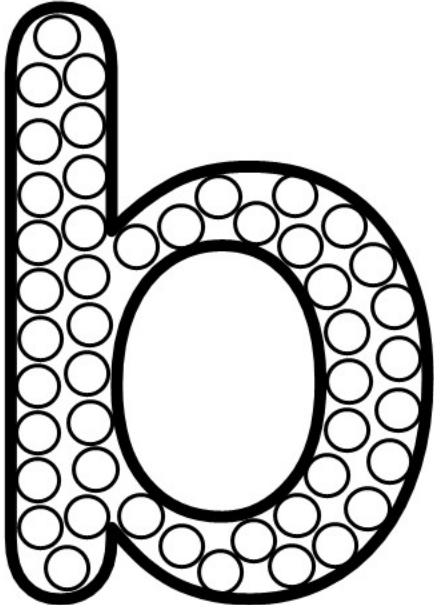
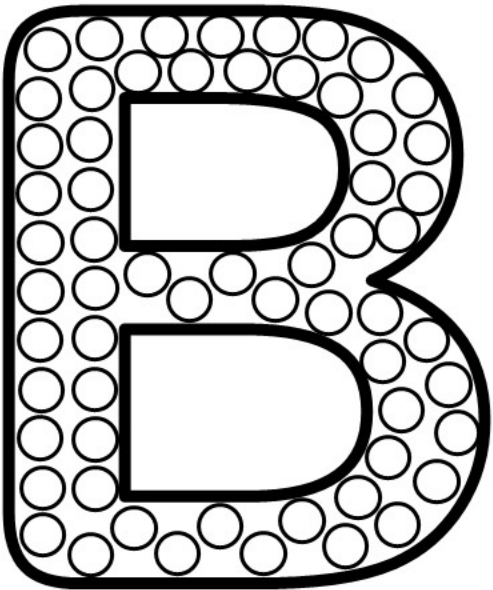
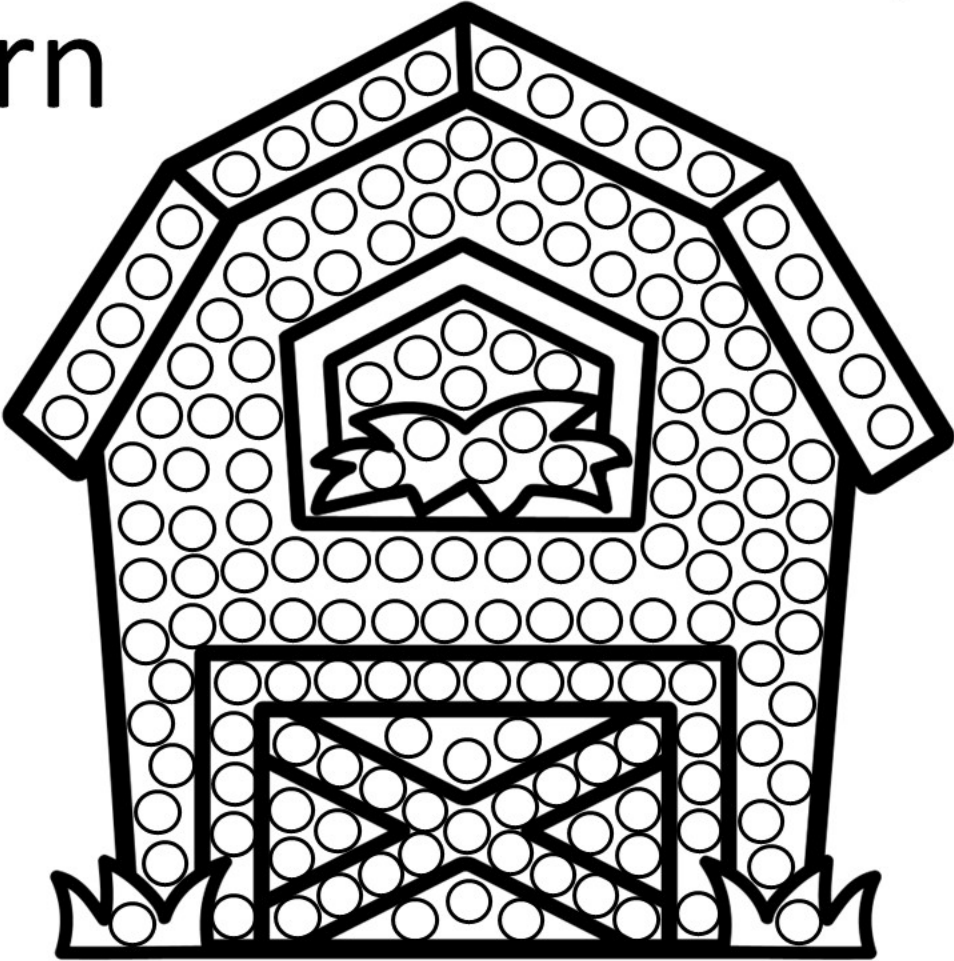

Cow

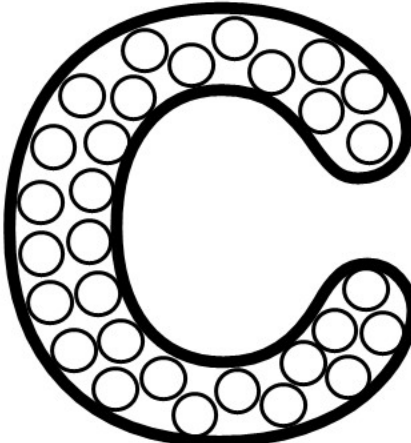
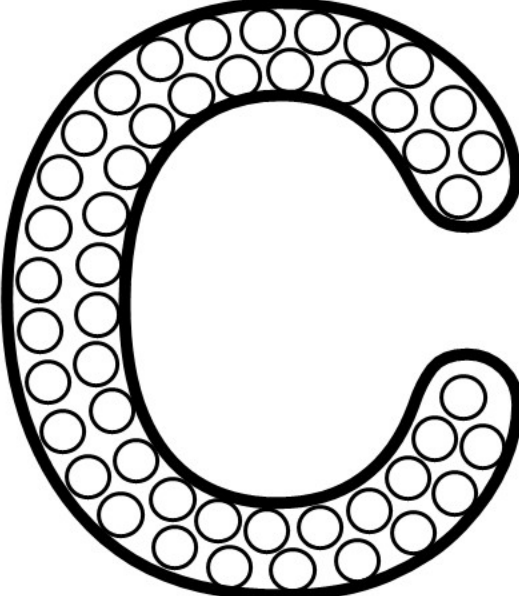
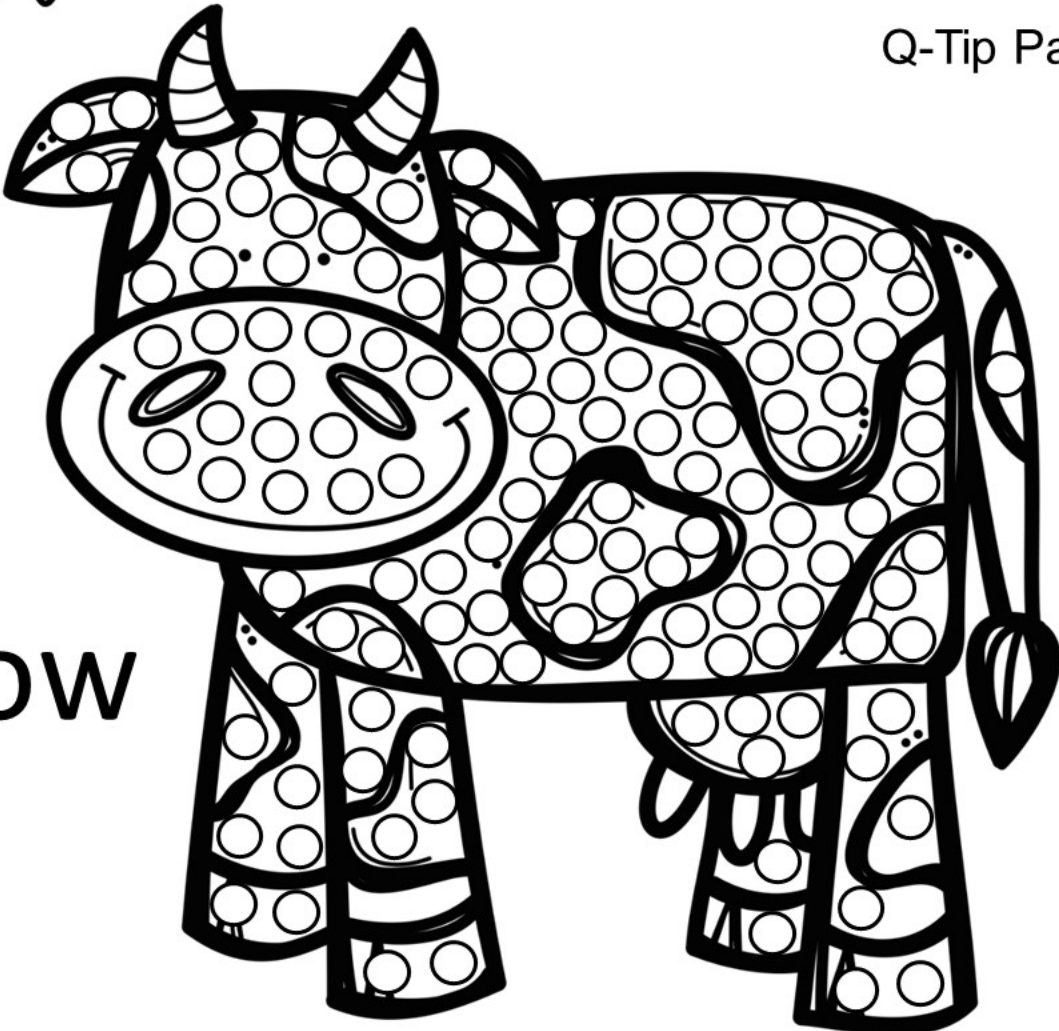

Q-Tip Painting

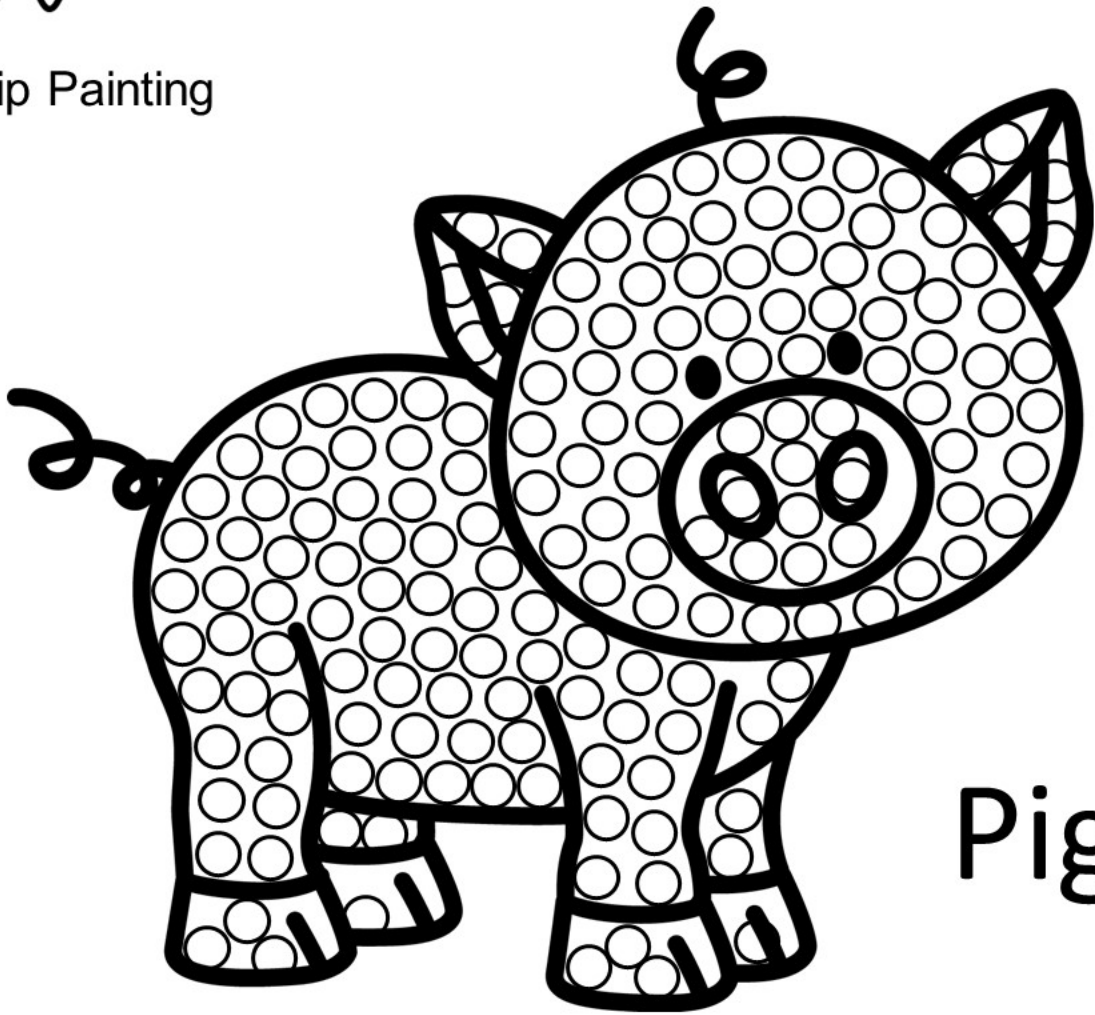

Pig

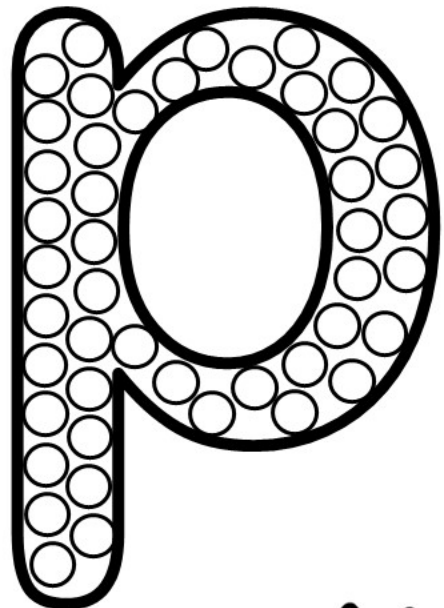
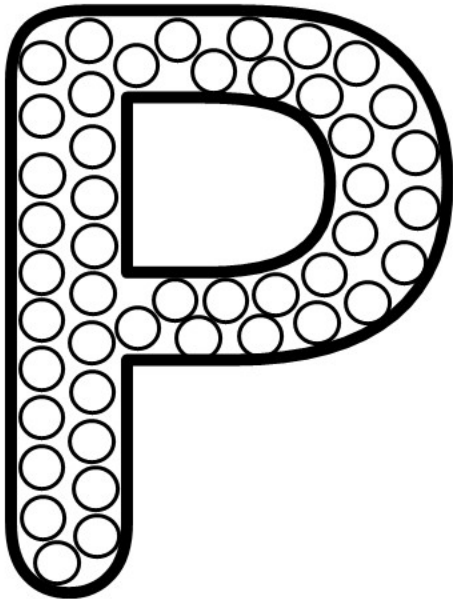

Down on the Farm Playdough Mats

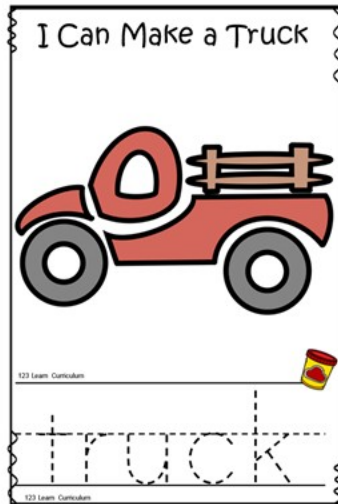

Supplies needed:

- White card stock
- Laminating sheets
- Assorted colors of playdough

Directions:

- Print up playdough mats onto white cardstock.
- Laminate and trim.
- Have children sit at the table and make farm shapes on each card with playdough.
- Show children how to roll the playdough and create each shape.



Down on the Farm Playdoh Mats

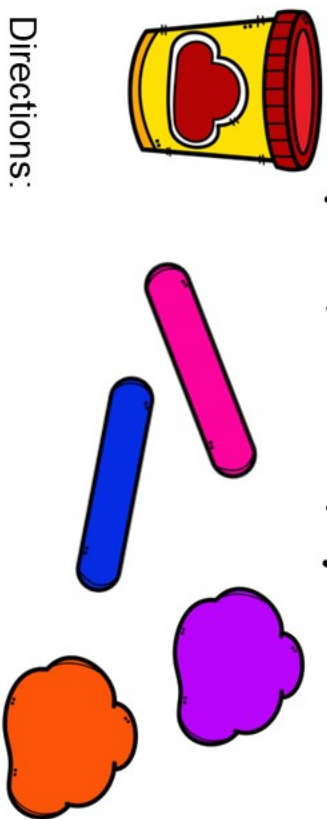

Directions:
Print up, laminate and trim.

Sit at the table with children and playdough mats. Talk to them about the mat they pick to use and read the card. Let them know what they need to do for each playdough mat. Show children how to roll the playdough to make pieces for the barn, truck, cow, chick, etc. to place on the pictures of the cards.

Children can also take the playdough and press onto the pictures to fill in the space. Kids will have fun working their fingers squishing and pulling the playdough.

You can also use dry eraser markers for preschoolers to write the words and wipe off.

I Can Make a Barn

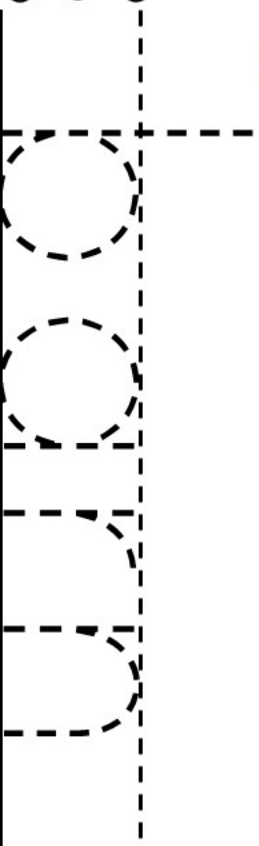
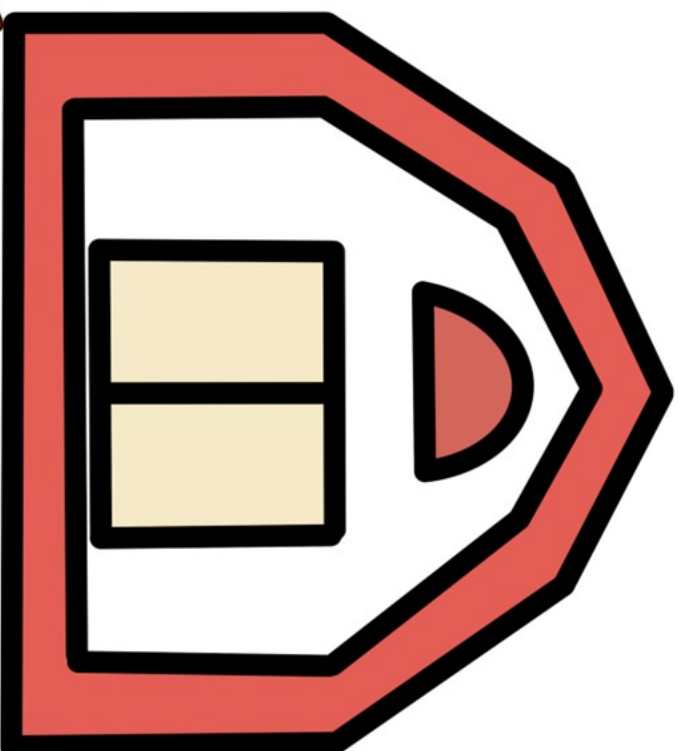

I Can Make a Truck

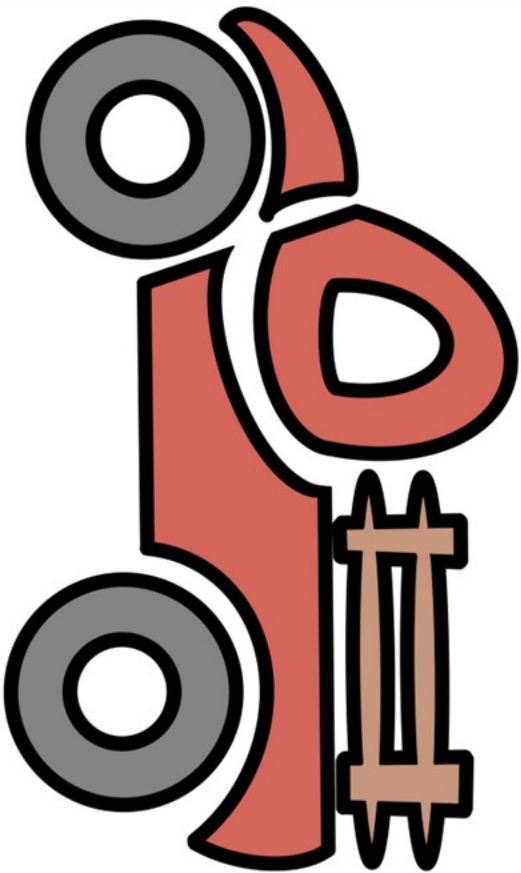

123 Learn Curriculum

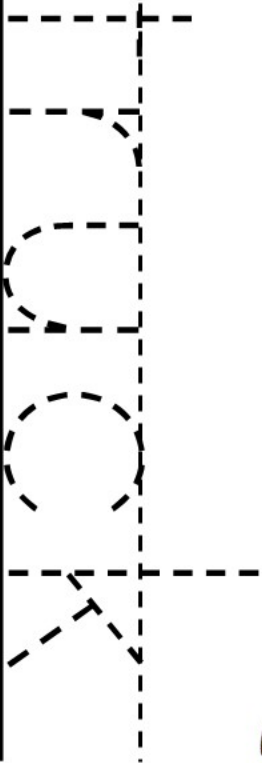

123 Learn Curriculum

I Can Make a Cow

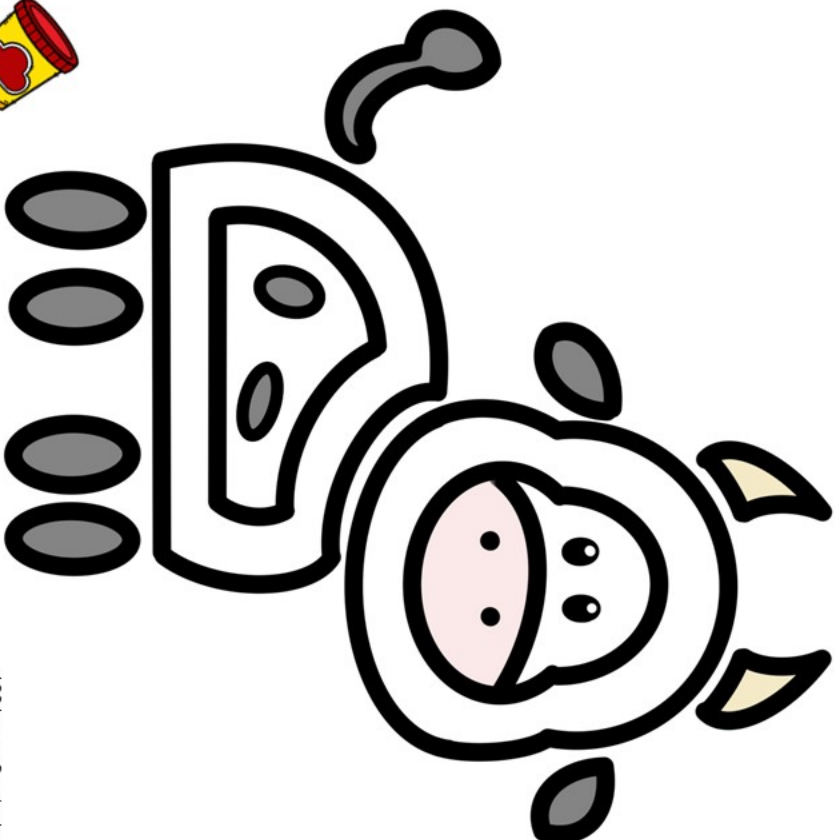

123 Learn Curriculum



I Can Make a Chick

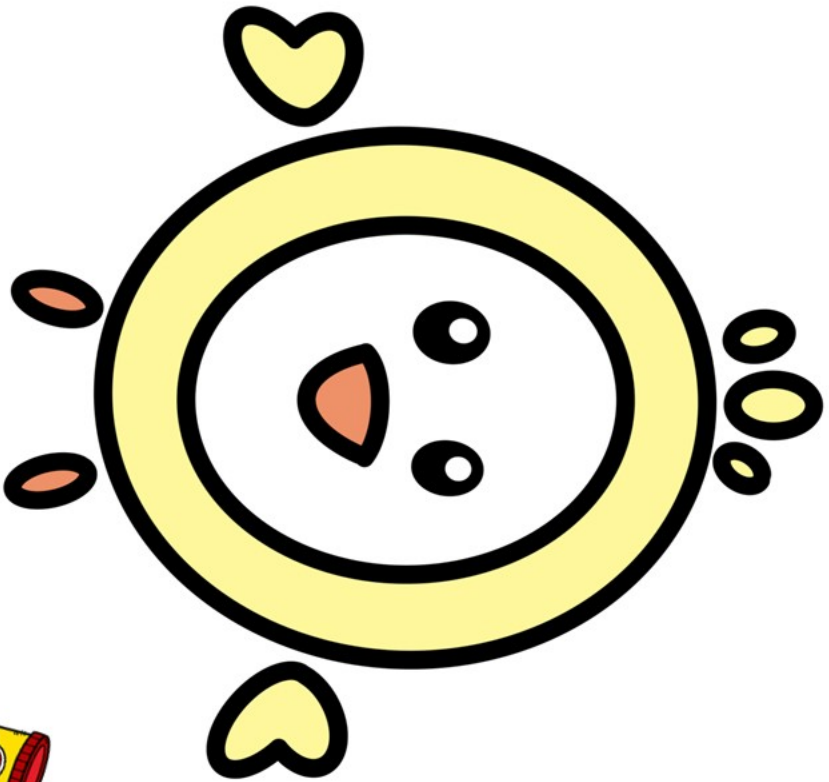

123 Learn Curriculum

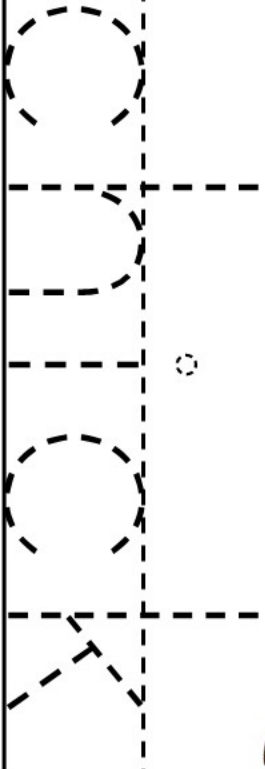

123 Learn Curriculum

I Can Make Mud

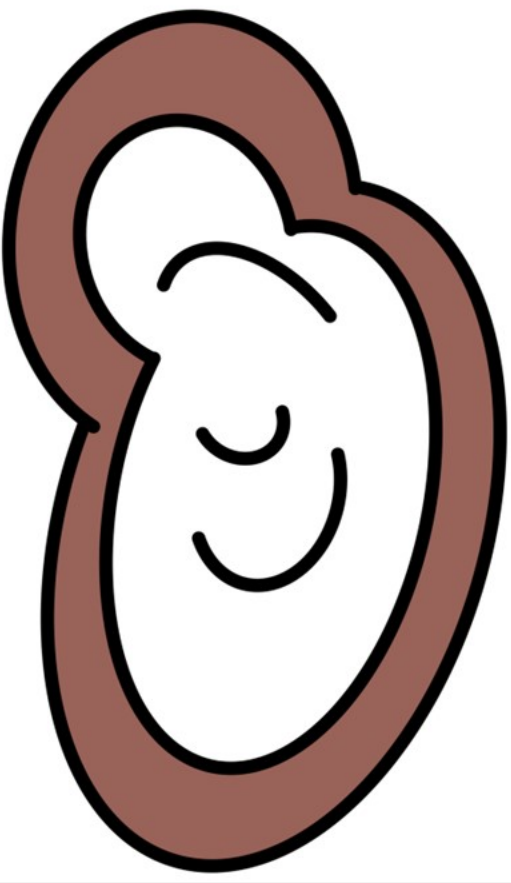

123 Learn Curriculum

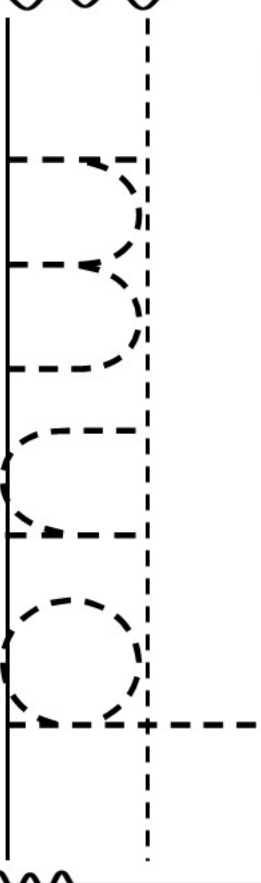

123 Learn Curriculum

I Can Make a Hen



123 Learn Curriculum

hen

123 Learn Curriculum

I Can Make a Farmer

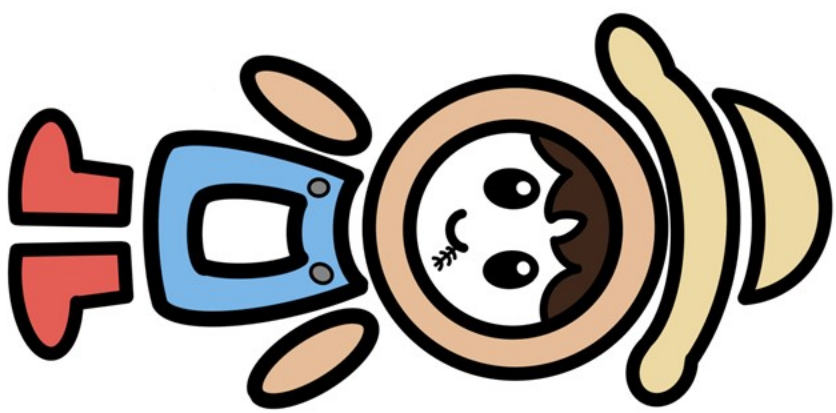

123 Learn Curriculum

farmer

I Can Make a Pig

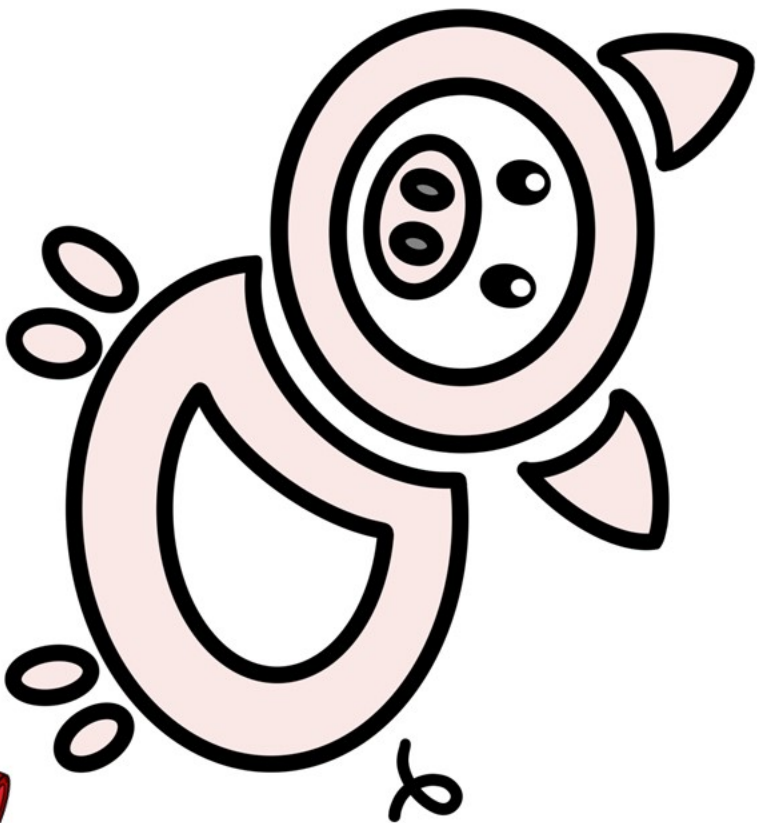

123 Learn Curriculum

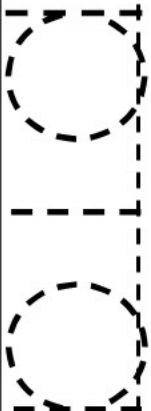

123 Learn Curriculum

I Can Make a Duck

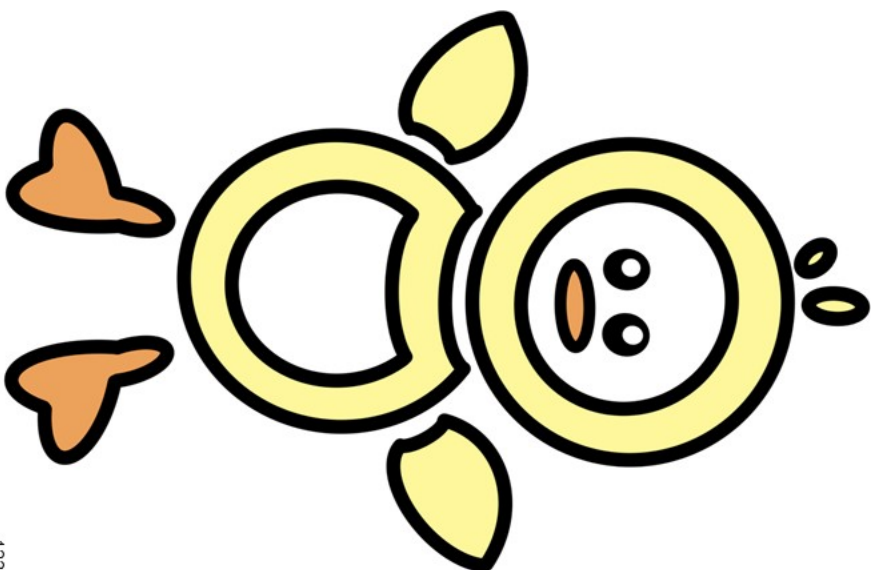

123 Learn Curriculum

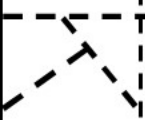
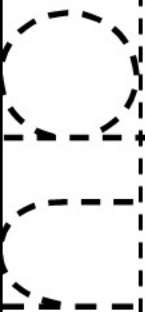

123 Learn Curriculum

I Can Make a Sheep



123 Learn Curriculum



123 Learn Curriculum



I Can Make Hay

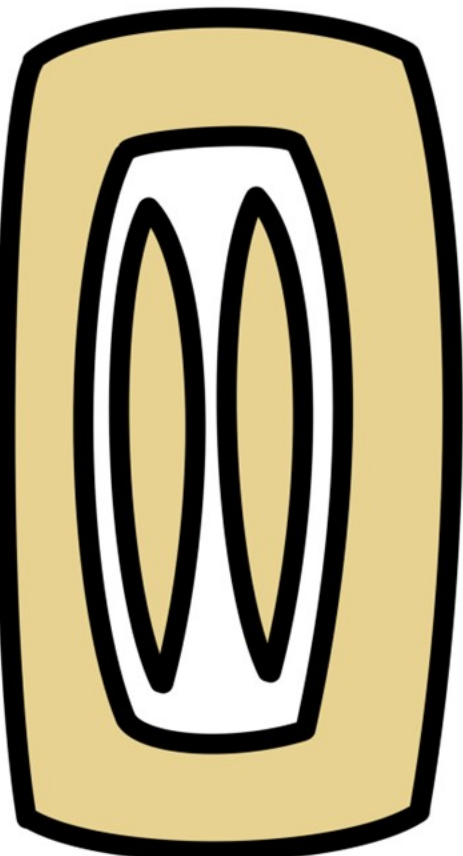

123 Learn Curriculum



Farm Letter Match

Materials:

- White card stock
- Stickers
- Black sharpie marker

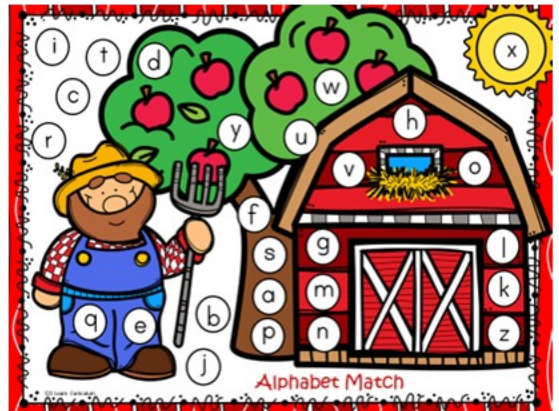

Directions:

1. Print up sheet onto white card stock.
2. Take a strip of stickers and with a black sharpie marker, print letters A – Z uppercase. Write uppercase alphabet on 4 set of different color stickers. Trim so children get an assortment of different colored alphabet.
3. Have children sit at the table and with a sheet place stickers on the correct lowercase letter.

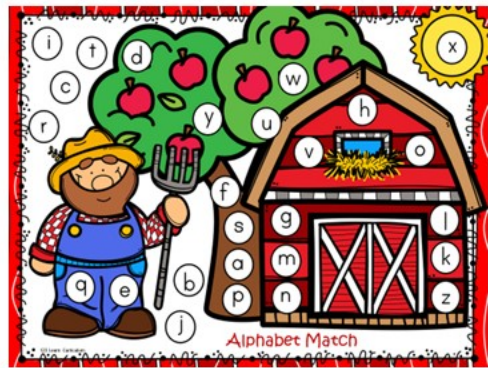
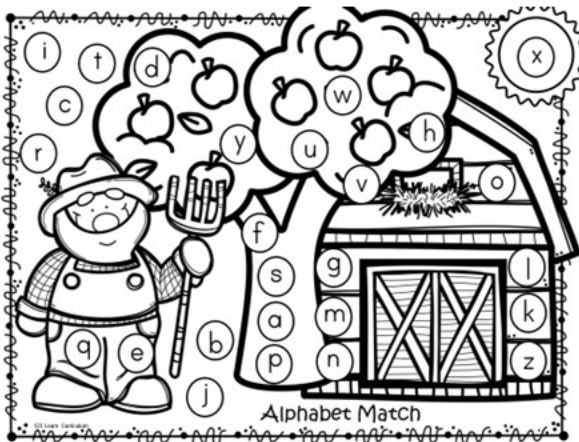

Letter match also comes in b & w. Have children color and then place uppercase alphabet letters on the matching lowercase letter.



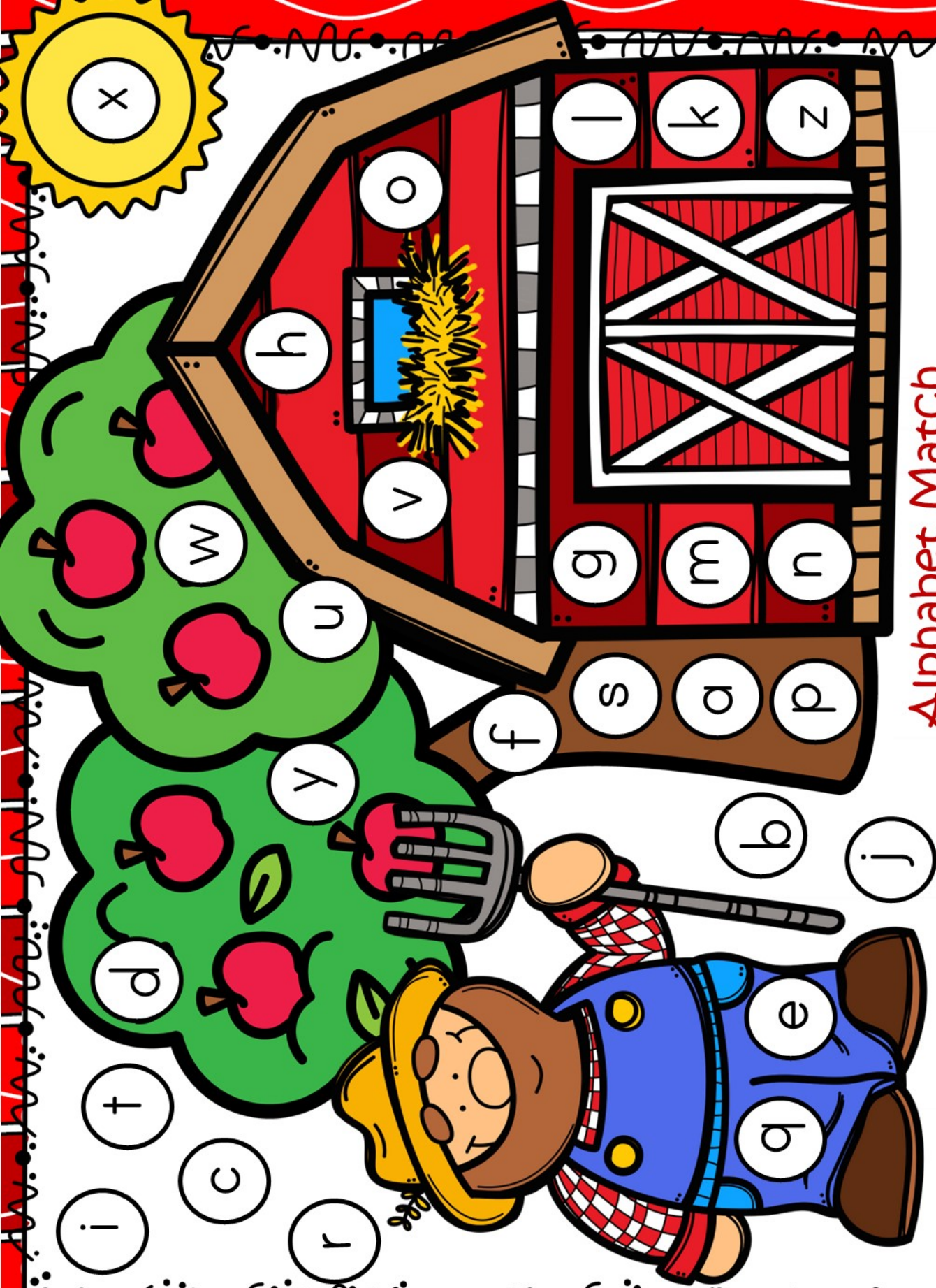

Alphabet Match

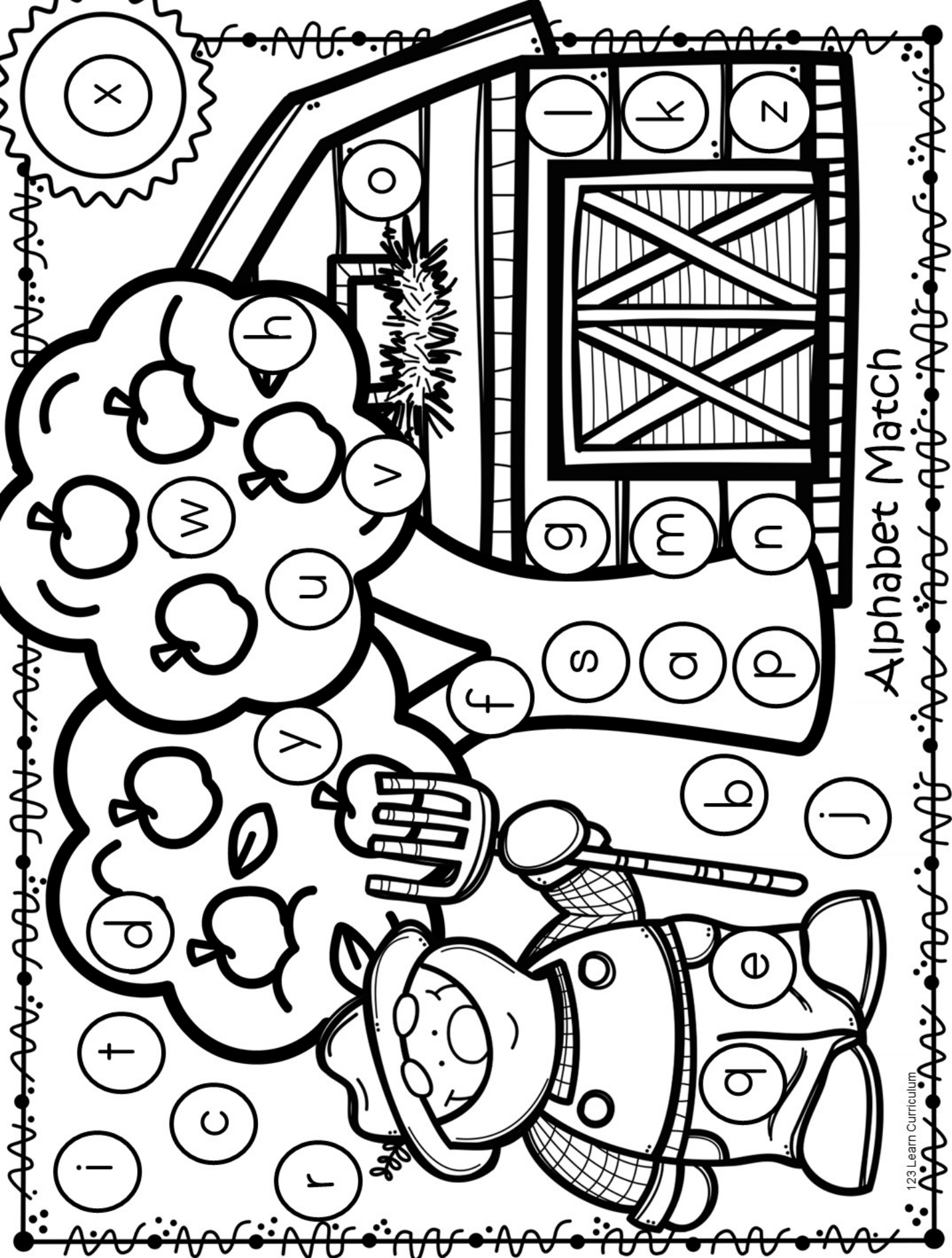

Alphabet Match

Farm Graph

Print up the following sheet. Using crayons or markers have children count the farm pictures and color the correct number of squares in the graph.

What farm picture comes up more.

Name _____

Farm Graph

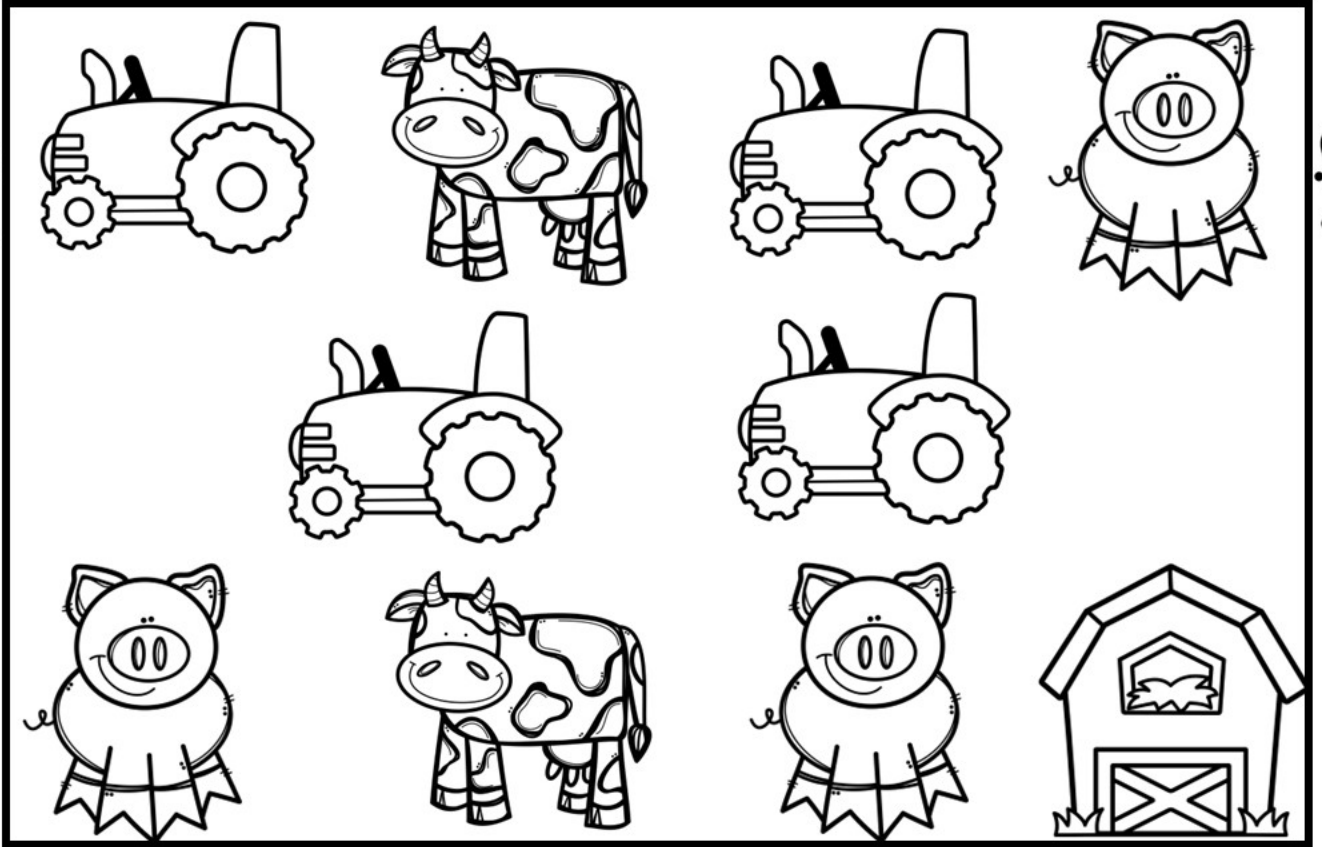

Count the superheroes and color the squares.



Active Learning

Pick 3 items to do this week for active learning from the following sheet.

In the space below type in the 3 items you will be doing for the week.(Use Dramatic Play, Math, Art, Writing, Science or Blocks.

1.

2.

3.

Active Learning

ECIPs

1. Social and Emotional Development
2. Approaches to Learning
3. Language, Literacy and Communications
4. The Arts
5. Social Systems: Cognitive
6. Physical and Movement Development
7. Mathematics
8. Scientific Thinking

Dramatic Play – Domain: Social and Emotional

Component: Social Understanding and Relationships:

Subcomponent S7 Building relationships: Child establishes and sustains relationships with others

S7.6 Seeks out familiar adults and children for conversation and play

S7.8 Shares information and participates in activities with adults and peers

S7.9 Builds friendship through play, learning activities and conversation with peers

Math – Domain: Mathematics

Component: M1-6: Number Knowledge

Subcomponent M1 Rote counting

The child attends to sequences and use of number words, with or without items, sets, or numerals and without recognizing the link to quality

M1.8 Shows interest in counting or number oriented play, and notices numbers in the environment during free play

M1.12 Points to objects while reciting number word sequence

Art – Domain: The Arts

Component: A1-2: Exploring the Arts

Subcomponent A1 Child shows an interest in learning about different artistic experiences

A1.3 Investigates different art experiences

A2.3 Chooses a artistic expression of their choice

A1.4 Selects their own art experience during play

A1.5 Integrates a variety of art experiences during play

Active Learning – Cont.

Read/Listen – Domain: Language, Literacy and Communications

Component: Emergent Reading

Subcomponent L4 Motivation, engagement: Child has an interest in and sustained attention for literacy acts

L4.9 Focuses on a book while listening to the reader

L4.11 Offers a personal response to stories read aloud

L4.12 Actively participates in reading activities with enjoyment and purpose

K 0.1.10.10 Actively participates in group reading activities with purpose and understanding including the appropriate selection of text for personal enjoyment,

Science – Domain: Scientific Thinking

Component: ST1-2: Discover

ST1 Observe and Question: Child demonstrates awareness and engagement with phenomena, materials, and environment

ST1.4 Asks Questions readily

ST1.6 Uses experiences to stimulate questions

ST1.8 Expresses curiosity and/or formulates questions of complex concepts

K1.1.2.1 Use observation to develop an accurate description of natural phenomena and compare one's observational and descriptive with those of others

Blocks – Domain: Physical and Movement Development

Component P5-6 Fine Motor

Subcomponent P5 Dexterity: Child can coordinate and control movement of hands and fingers to grasp and manipulate objects

P5.11 Stacks 4 blocks

ACTIVE LEARNING: (ACTIVITY AND LITERACY PROPS)

Dramatic Play - Set up an area of the playroom as a farmers' market. Have plastic fruits and vegetables, small baskets for shopping. Print up labels, open and closed sign, farmer's market banner. Other items, cash box with play money, play scale for weighing.

Math - Farmer Number Roll and Cover

Art - Put out various materials for children to make items for your down on the farm theme. Put templates of barns with animal stickers, markers, crayons, shredded yellow paper (hay) and other items for children to decorate their own barns.

Read/Listen - Put farm themed books in the reading area. Go to your local library for other books about farmers and farms.

Writing - Put spin and write sheets in writing area.
Located in preschool small group section

Science/Sensory - The Floating Egg

Blocks - Have children use blocks and building farm structures. Place farm animals in the block center. (Print farm structures and hang in your block center).

Family Connections

Send a copy of My Friends on the Farm book home on Friday.

To Do List:

Make: Print up My Friends on the Farm, Farm number roll and cover, spin and write from small group section.

Buy: Items needed for dramatic play.

Gather: Items needed to put together activities, card stock, laminating sheets, if doing any cooking or baking have ingredients on hand.

Other: Go to your local library and ask the library to help you find more books about farms, farmers and farm animals.

Farmers Market Suggestions on Amazon. Click on picture to purchase, and also put farm toys in search bar.





Farmer Market Banner



Supplies needed:

- White card stock
- Yarn (string)
- Tape

Directions:

- Print up banner letters onto white card stock.
- Trim and fold on the dotted line.
- Figure out how long you want the banner to be and cut the string that length.
- Add the letters in order, place tape on the back of the folded piece and continue until all letters are added to the banner.
- Hang up in your dramatic area.



Fold each banner on the dotted line.

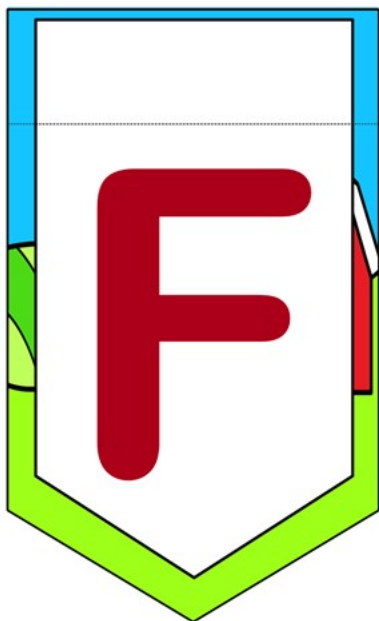

Place the folded banner on the string. Place a piece of Scotch tape on the back to hold in place.

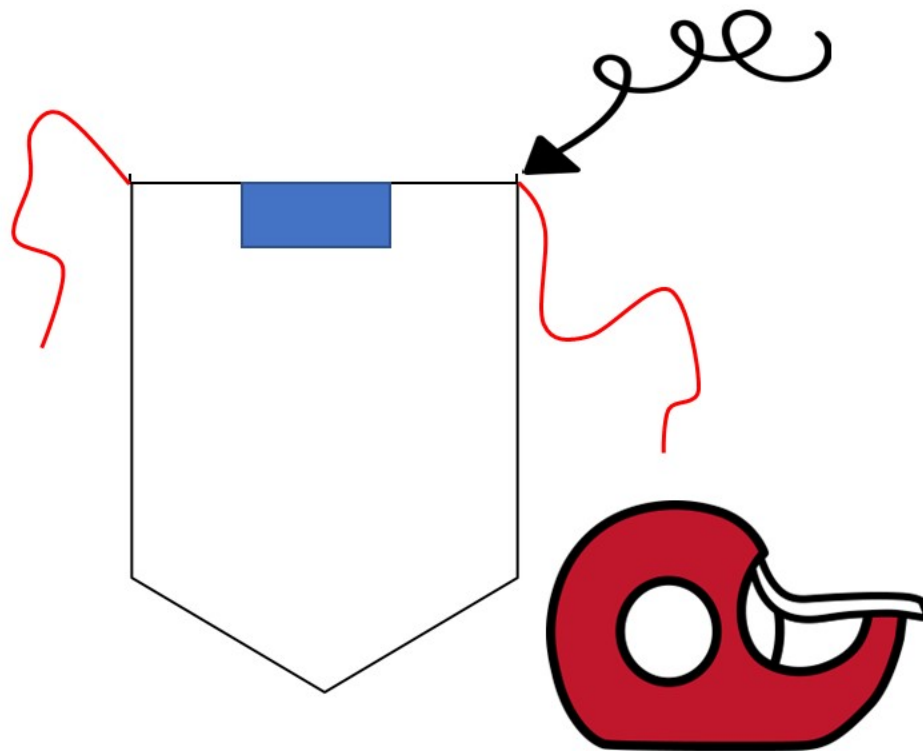

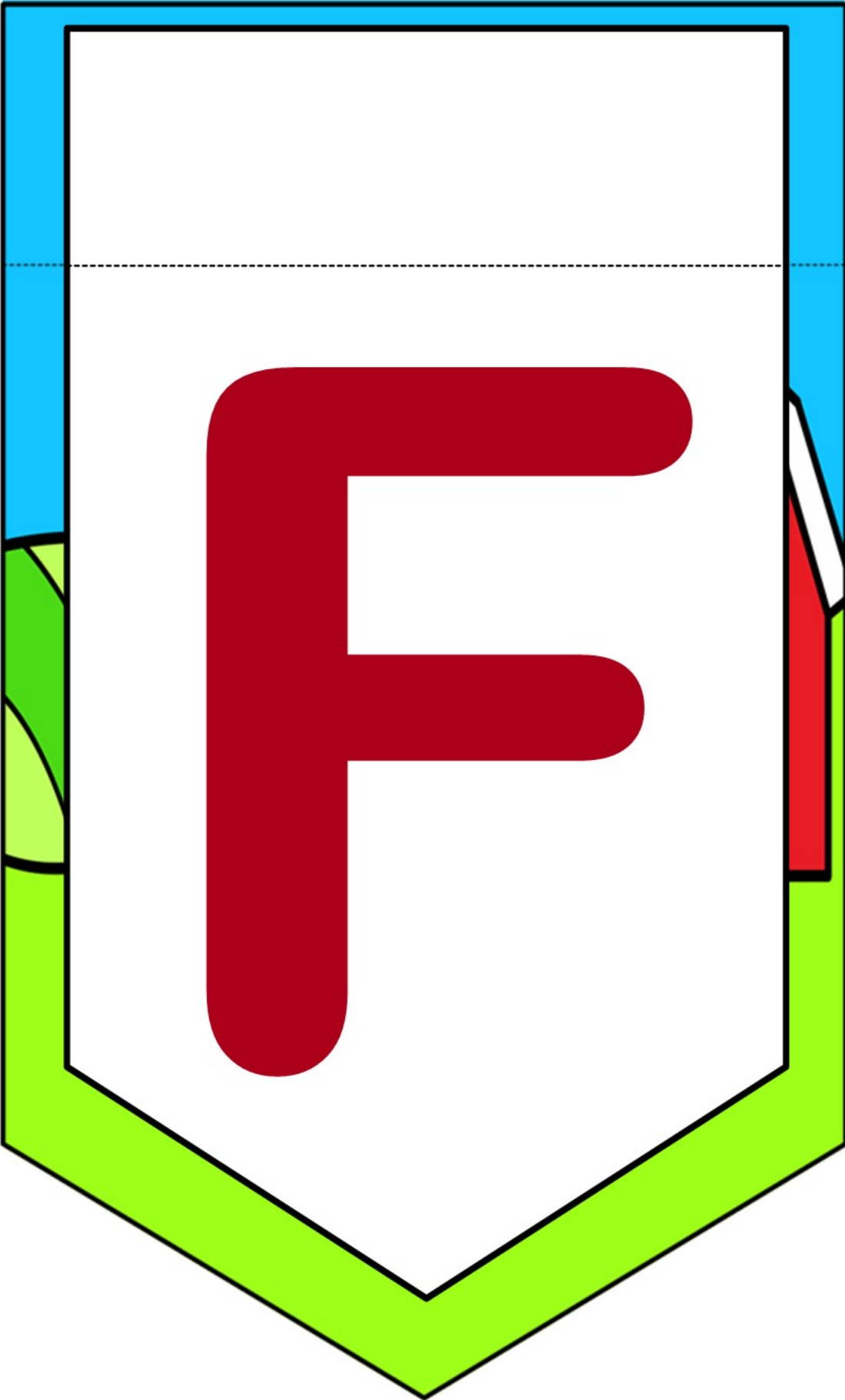

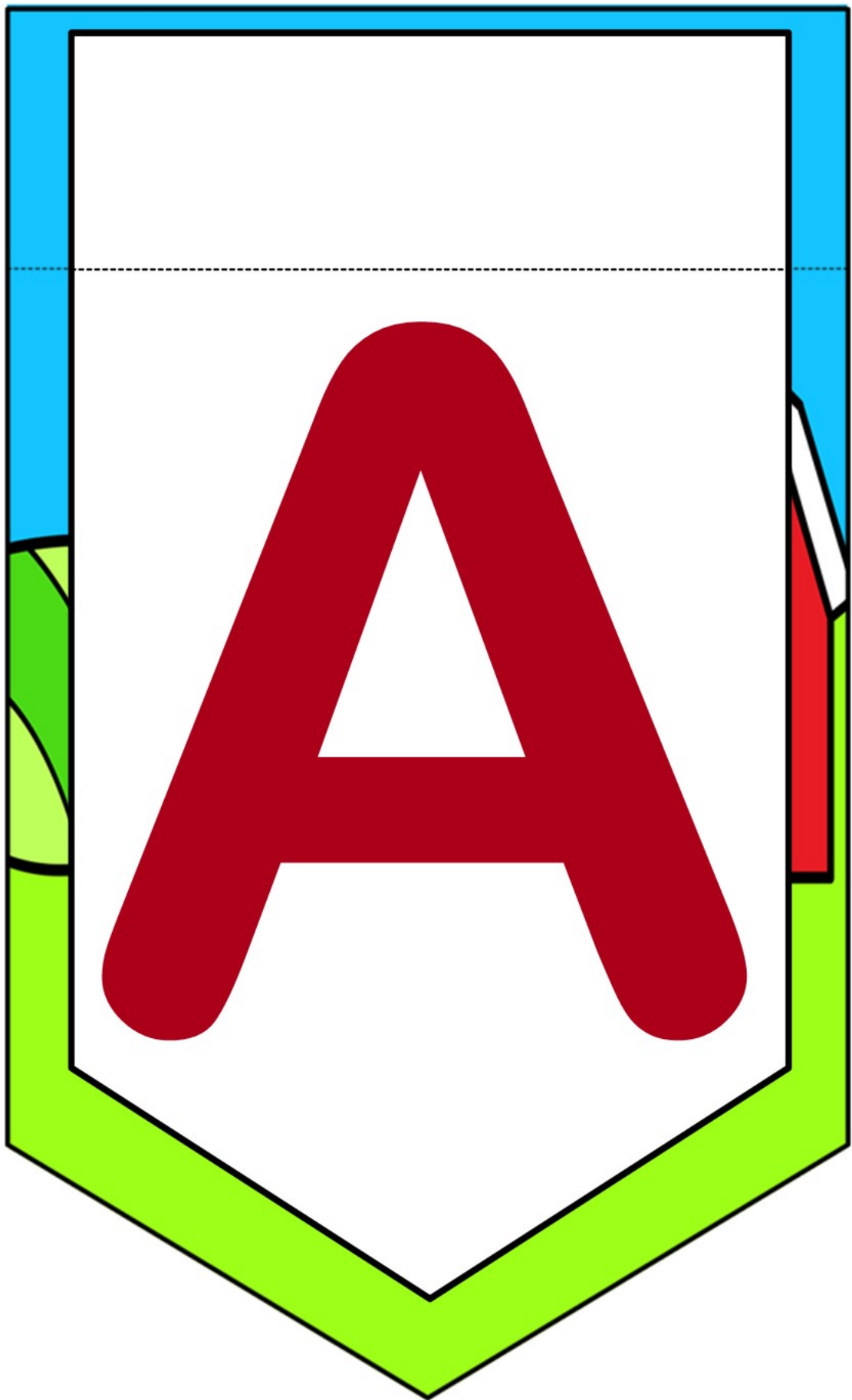

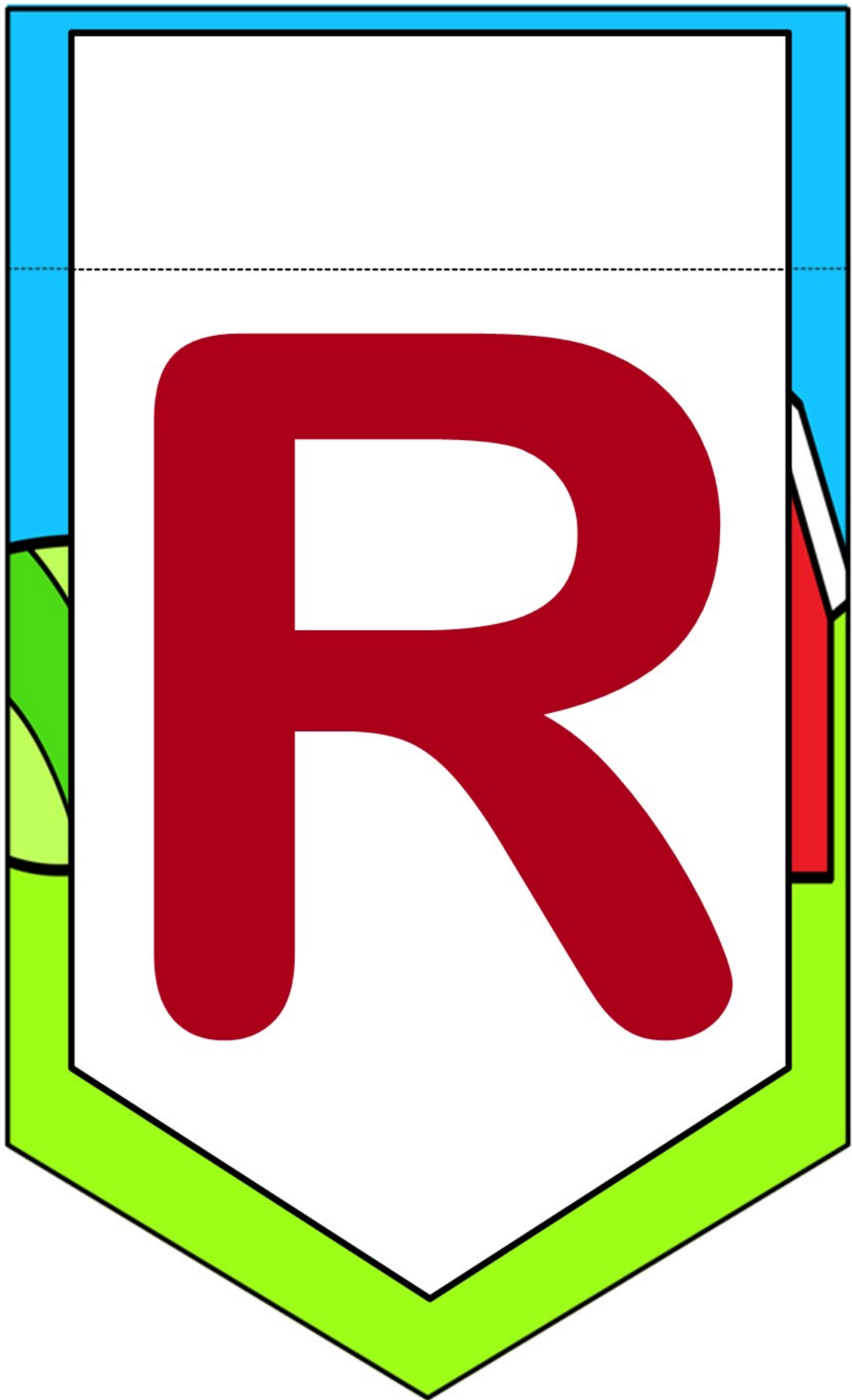

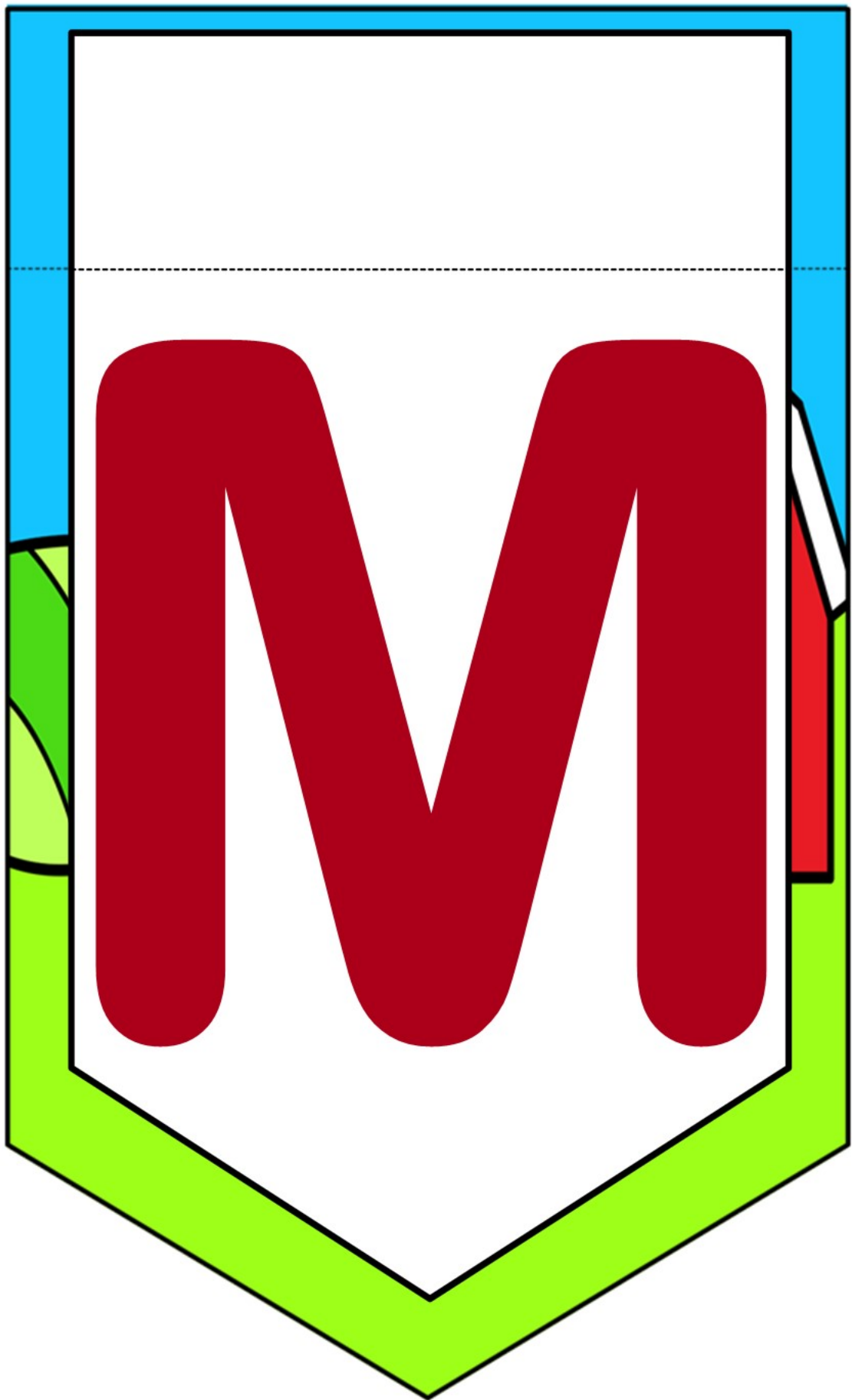

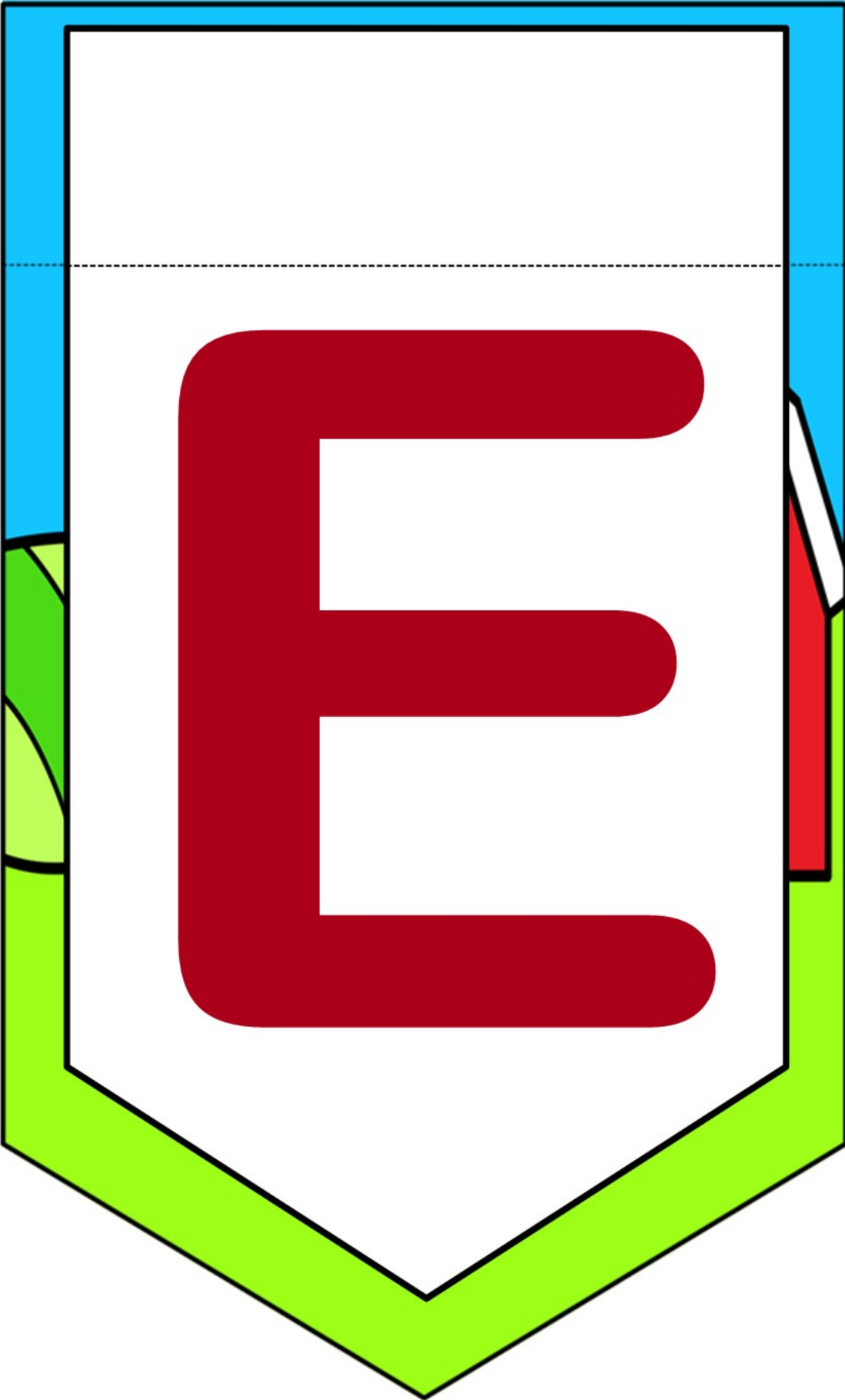

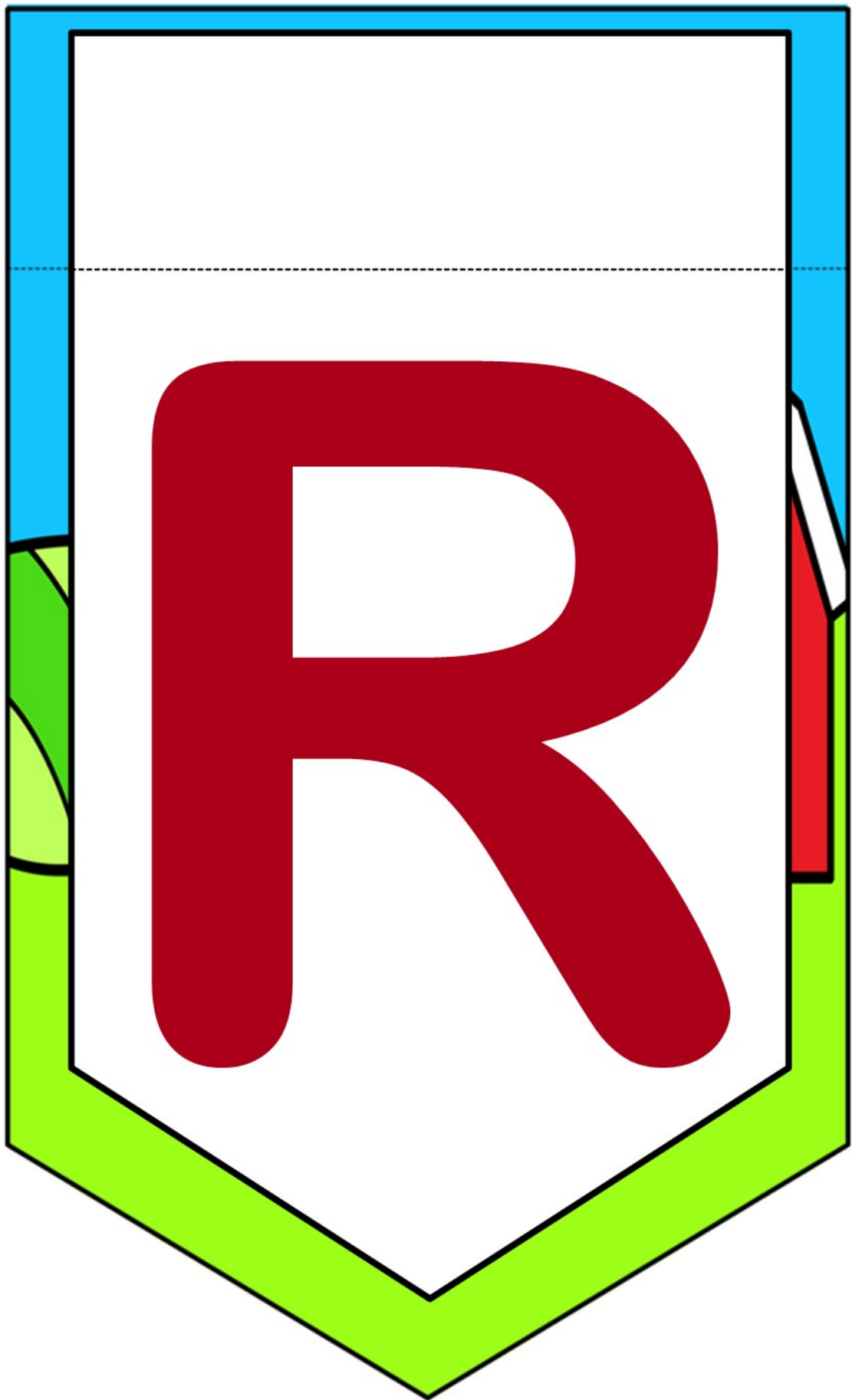

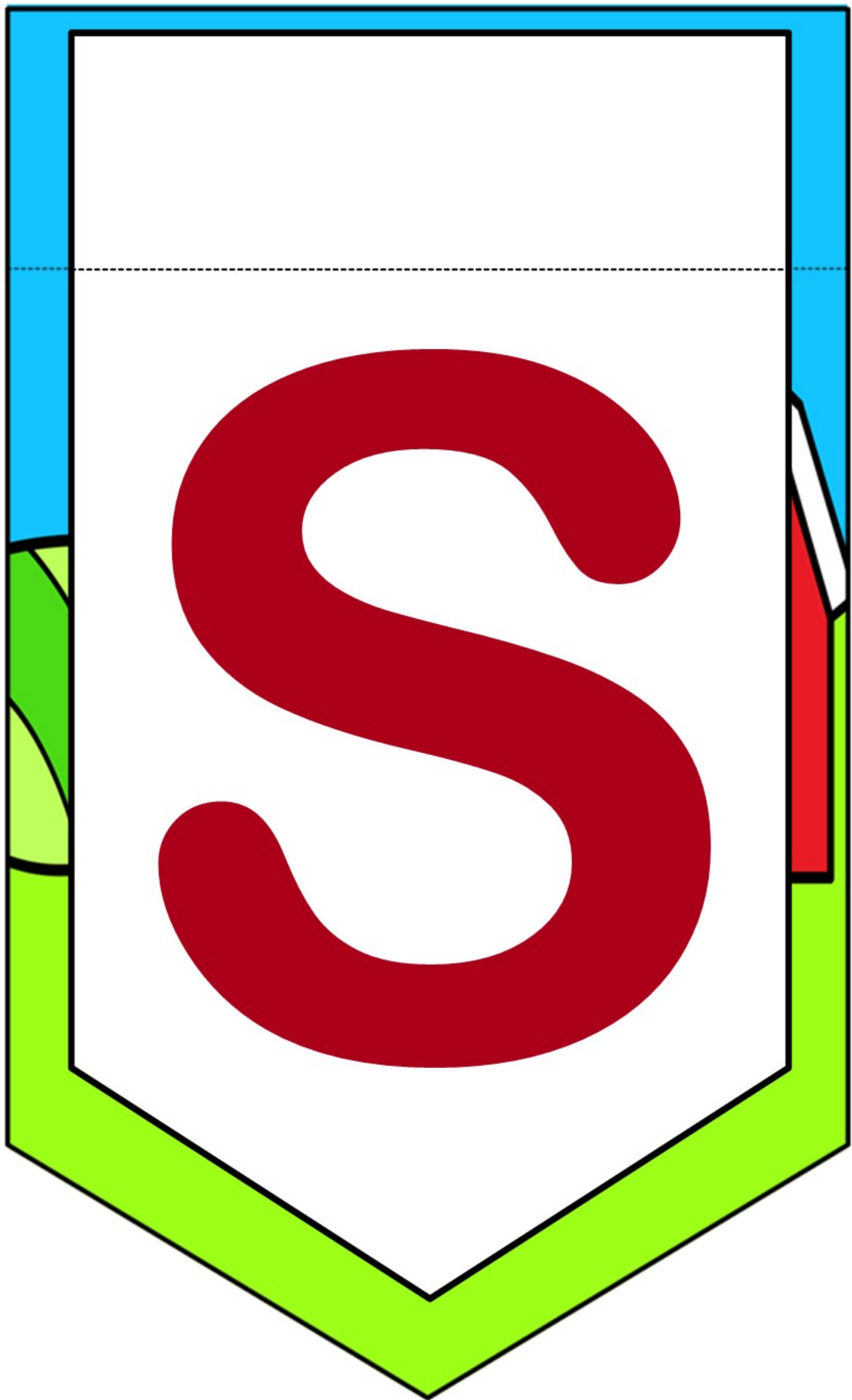

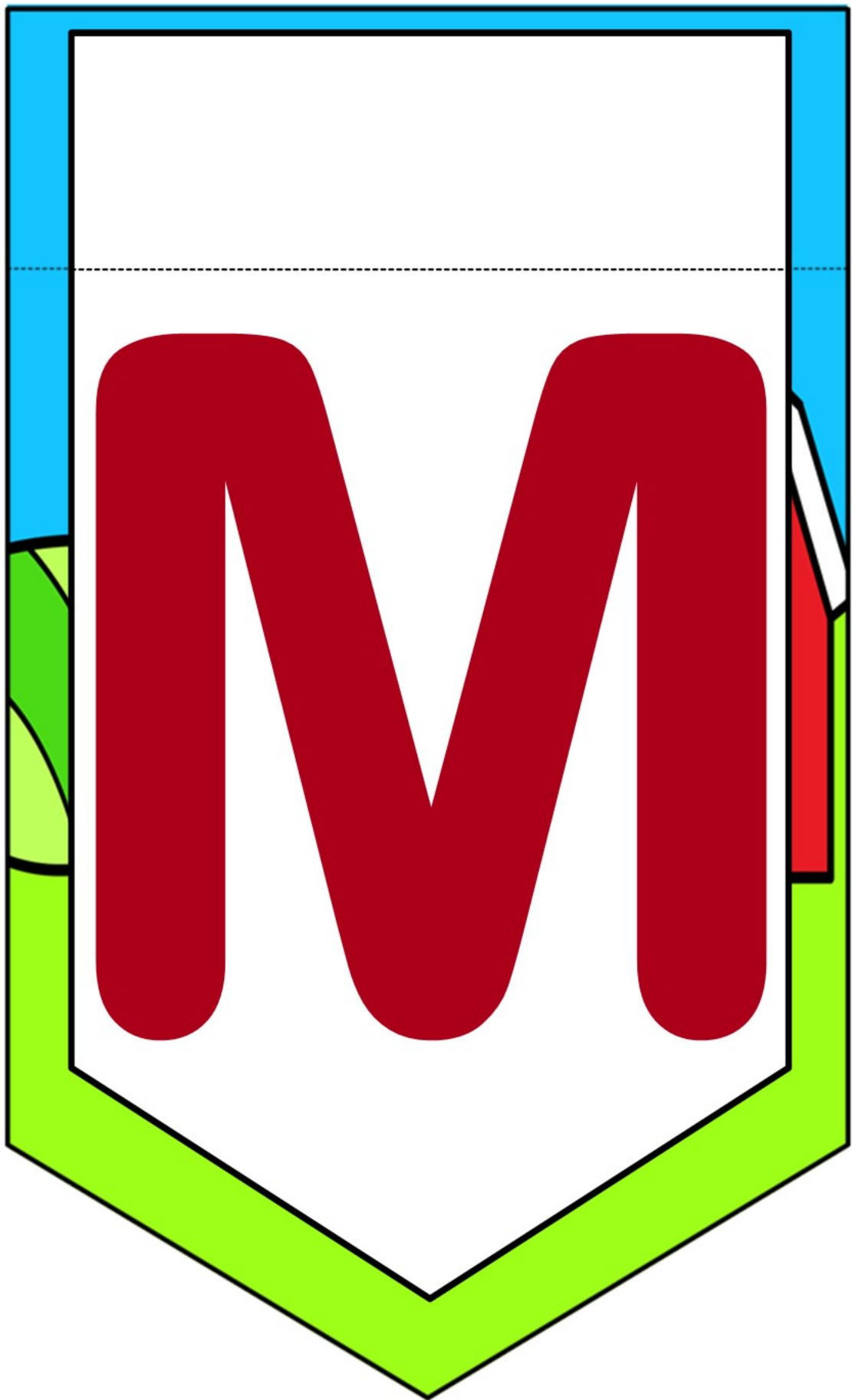

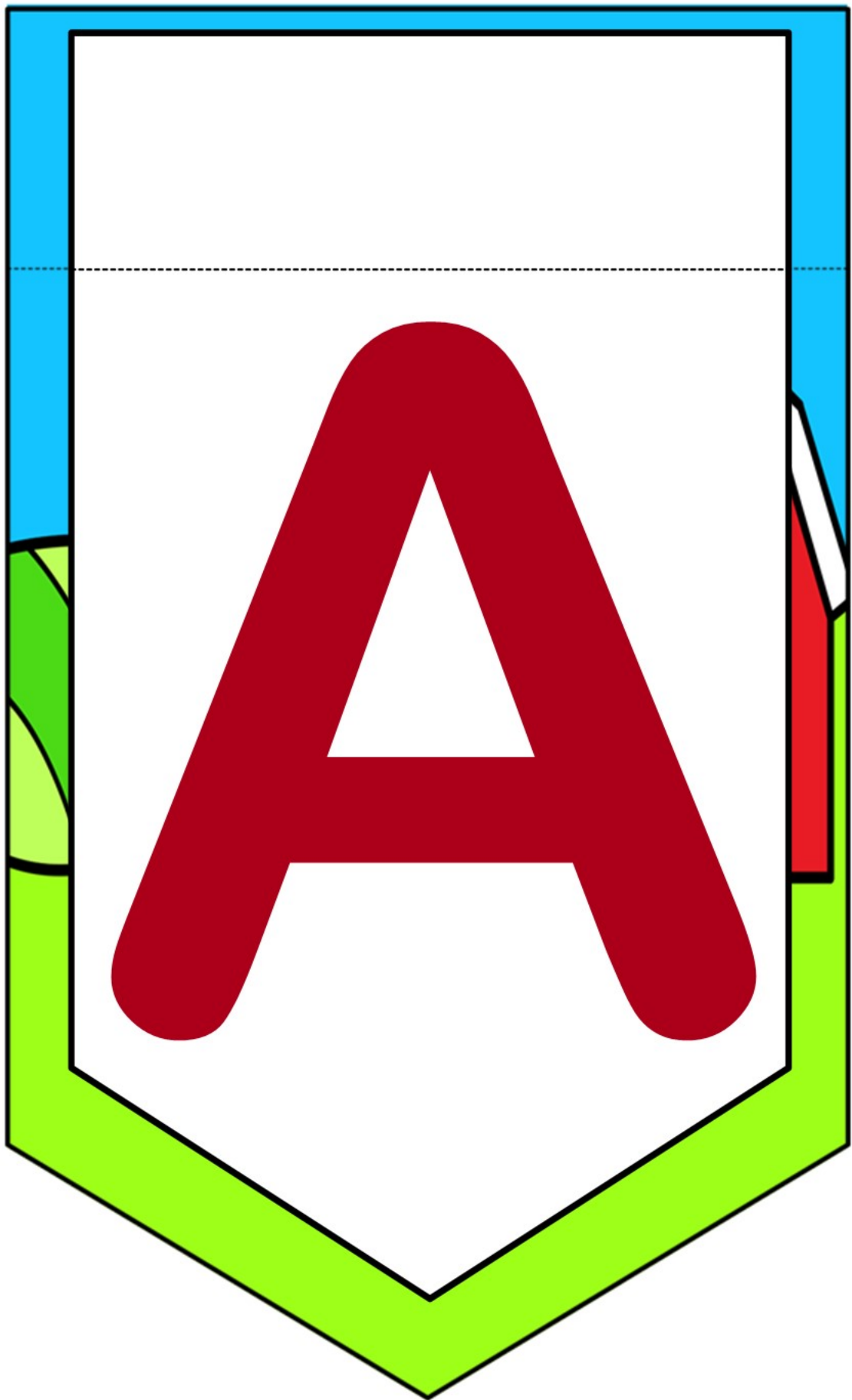

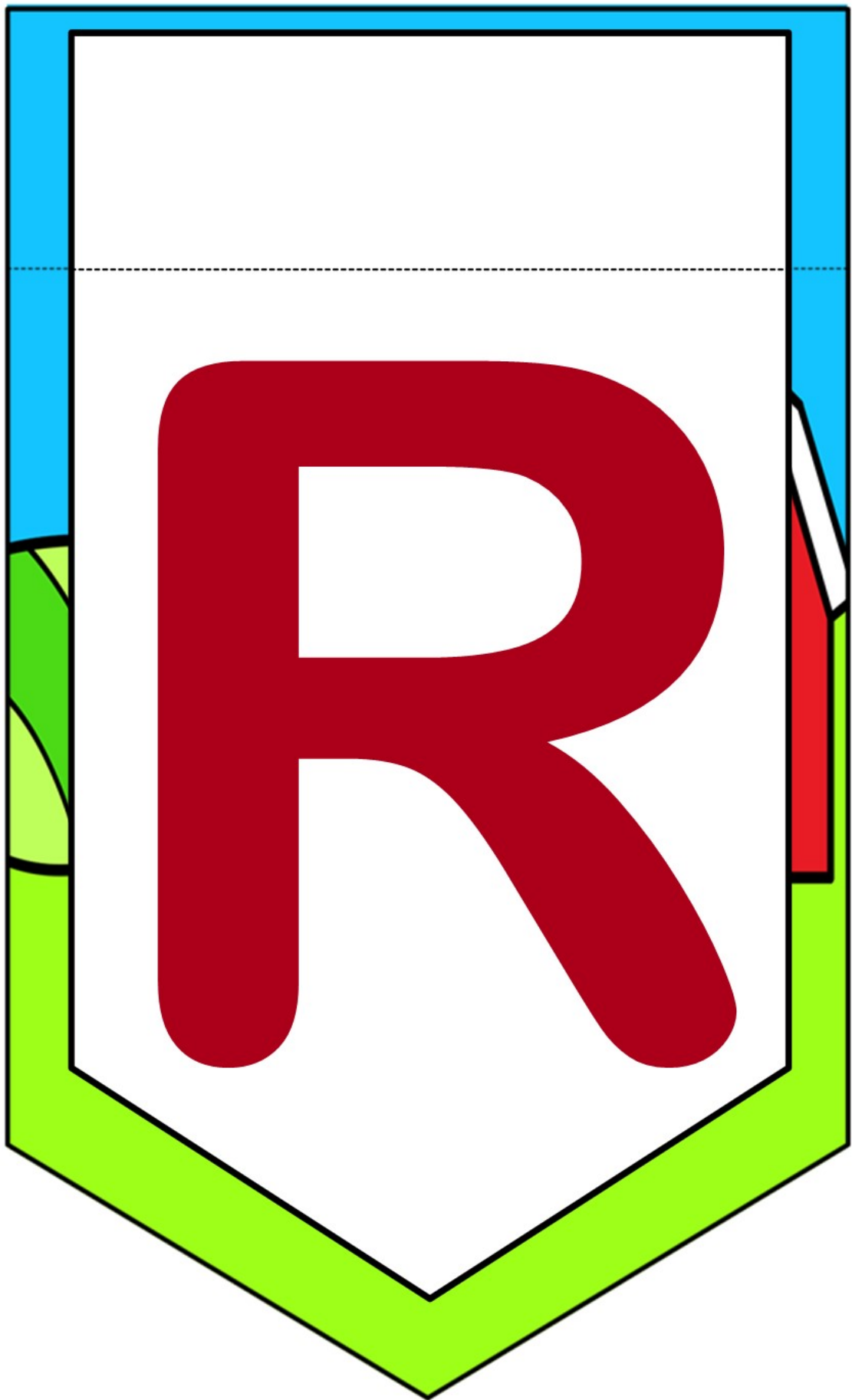

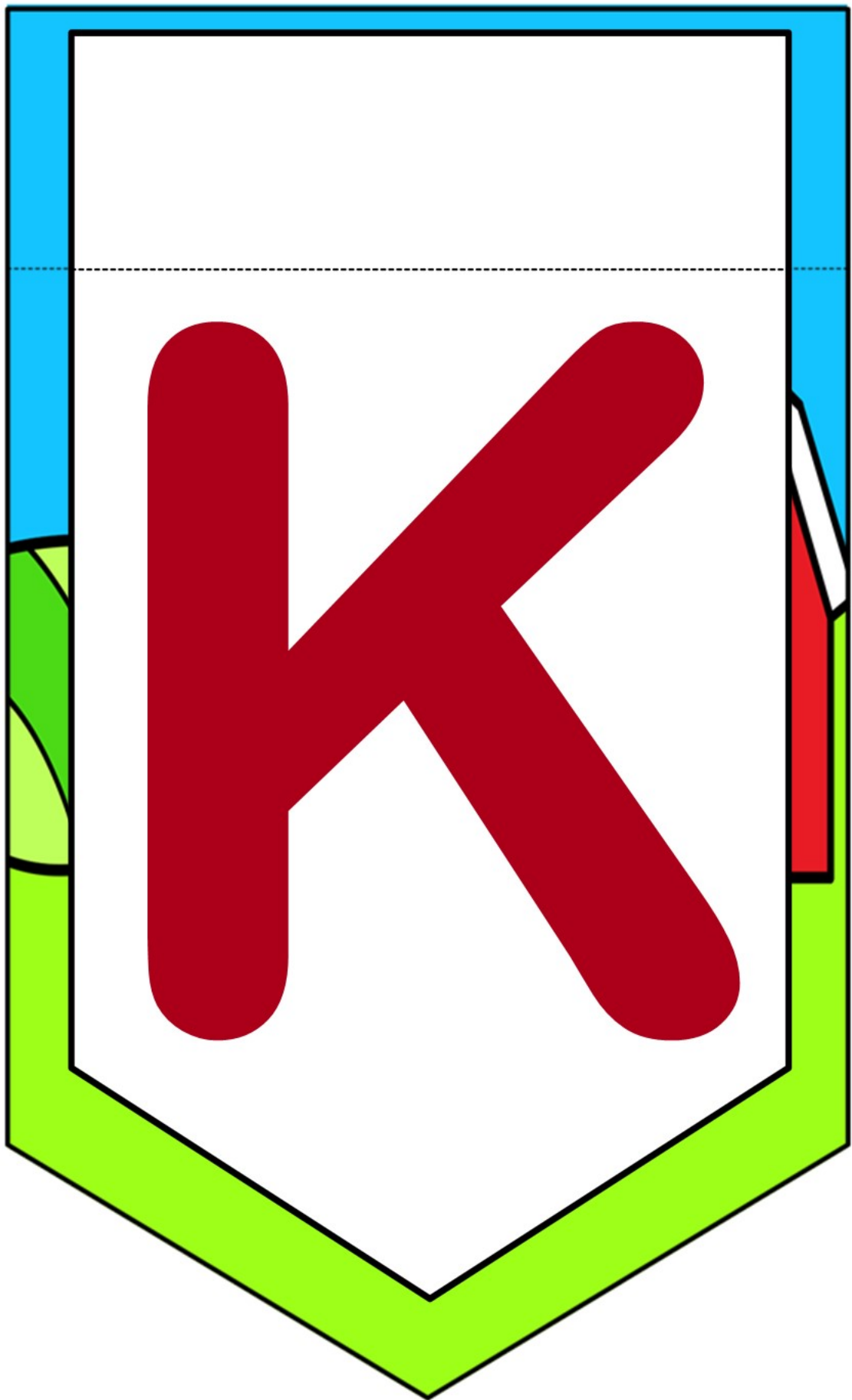

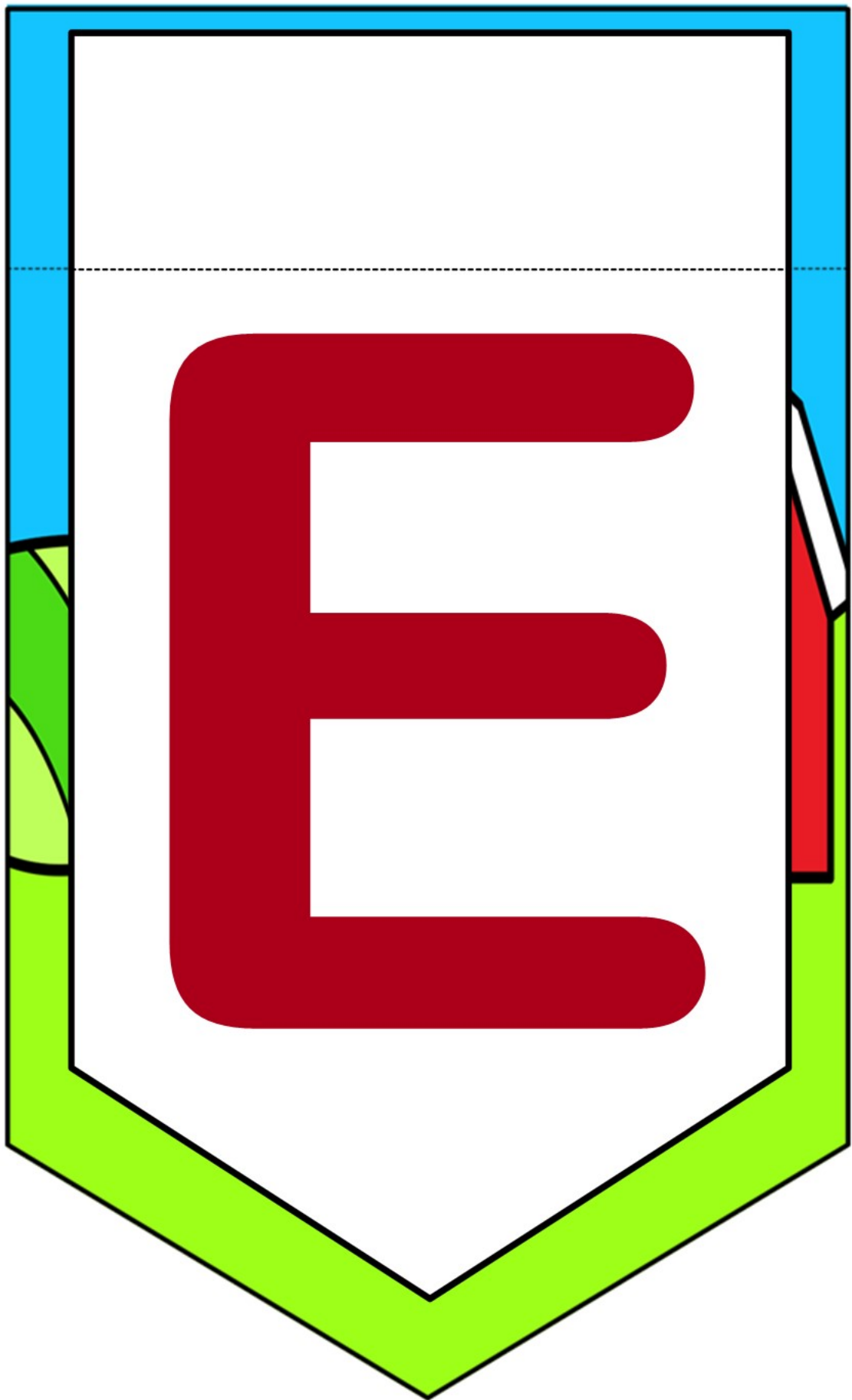

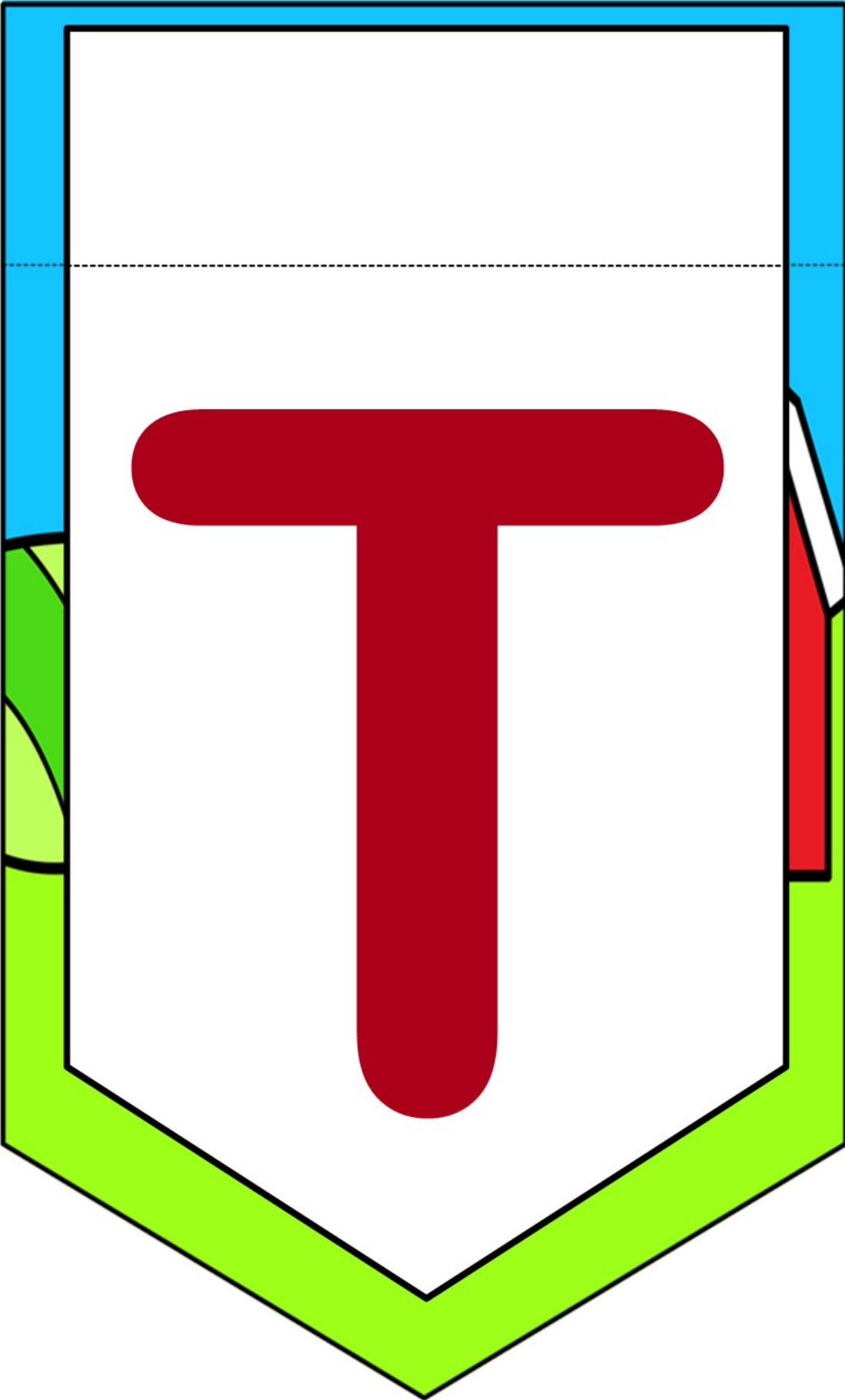

Farmer's Market Open / Closed Signs

You have 2 options for Farmer Market signs. Small and large.

Small Signs:

- Print up on white card stock.
 - Laminate.
 - Trim.
 - Hang up in your Farmer's Market.
-
- Large Signs:
 - Print up on white card stock – back-to-back.
 - Laminate
 - Trim.
 - Hang up in Farmer's Market.

Farmer's Market



123 Learn Curriculum

Farmer's Market



123 Learn Curriculum

Farmer's Market

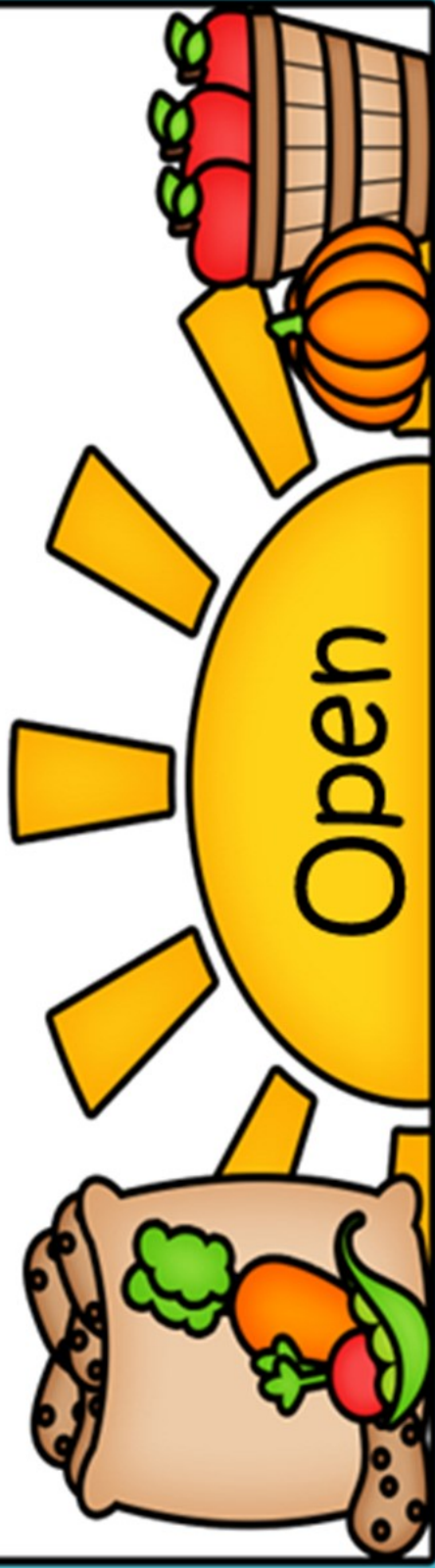

Farmer's Market

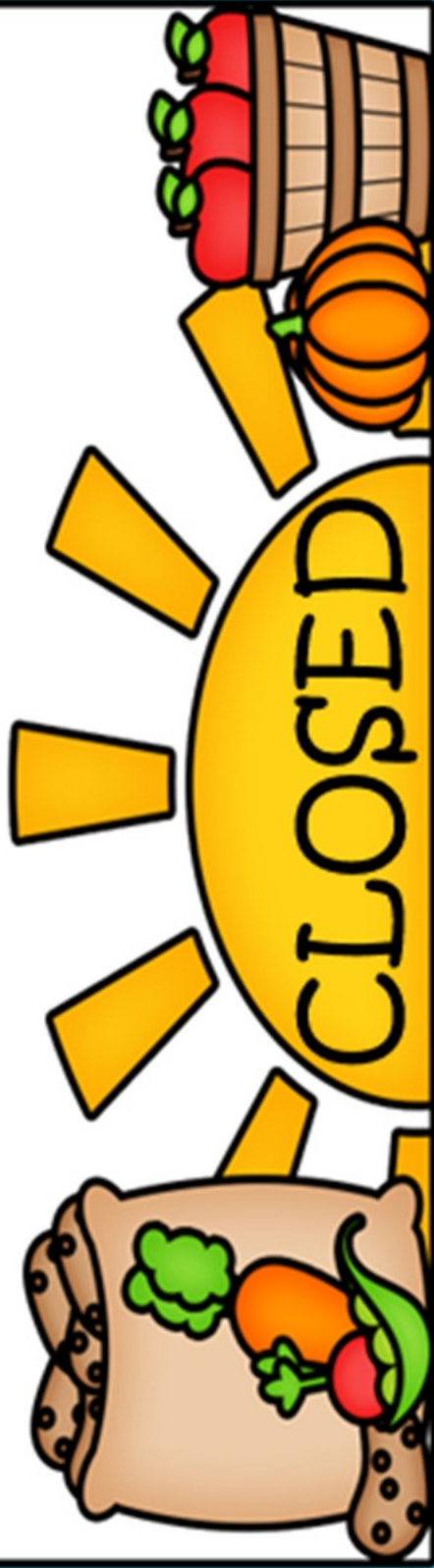

Today's Special Sign

- Print up on white card stock.
- The full Today's Special sign – Laminate and trim.
- Place a piece of Velcro on the sheet in the space provided.
- Today's Special cards – Print up on white card stock.
- Laminate.
- Trim.
- Place Velcro on the back of the today's special cards, and let children pick their today's special.

Today's Special

Velcro

Cucumbers
2 for \$1.00

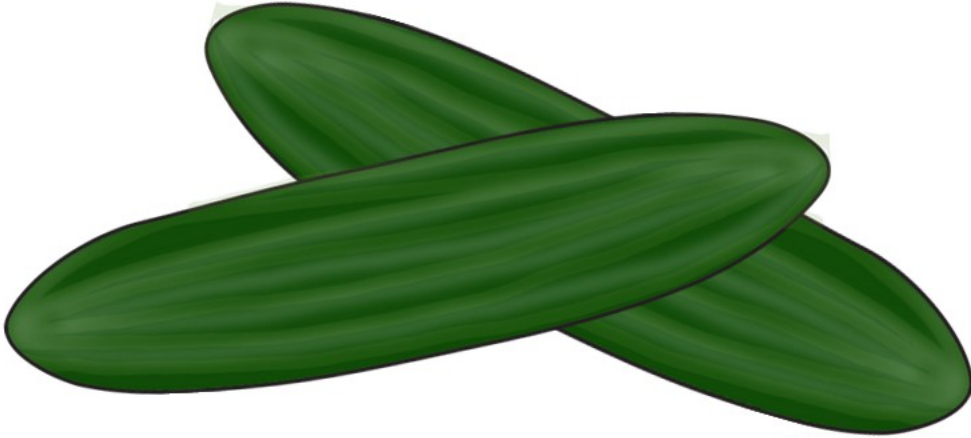

Corn on the Cob
6 for \$4.00



Watermelon
\$3.00

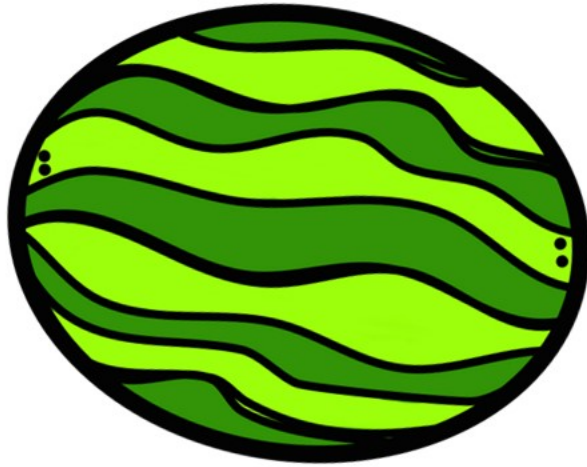

Bag Carrots
\$1.50



Head of Lettuce
\$2.00



Dozen Eggs
\$1.50

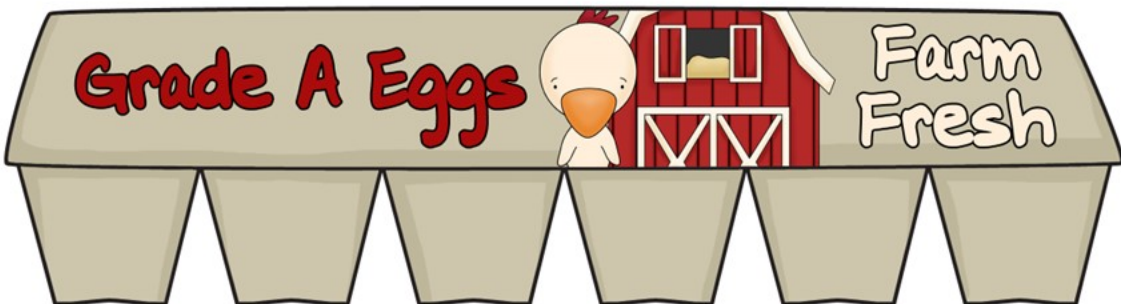

3 Tomatoes
\$2.00

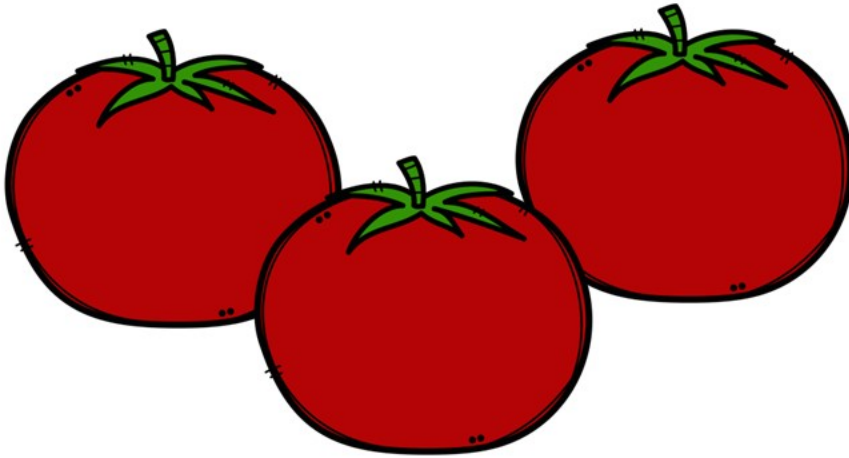

Bushel of Apples
\$3.50



Assorted Peppers
3 for \$1.50

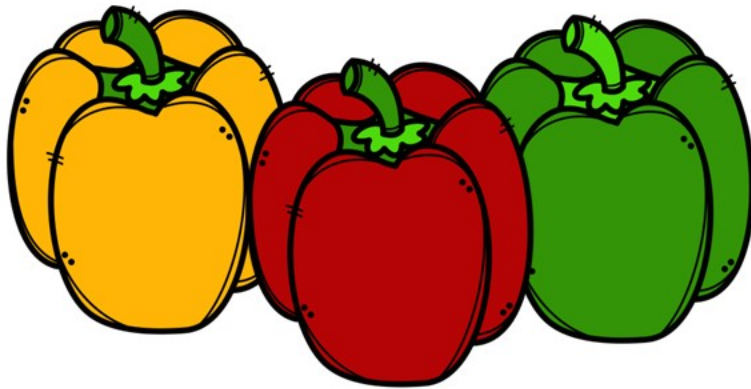

Pumpkin
\$4.00



Farmer Market Signs

- Print up on white card stock.
- Laminate.
- Hang around the farmers market.

Farm Fresh Eggs

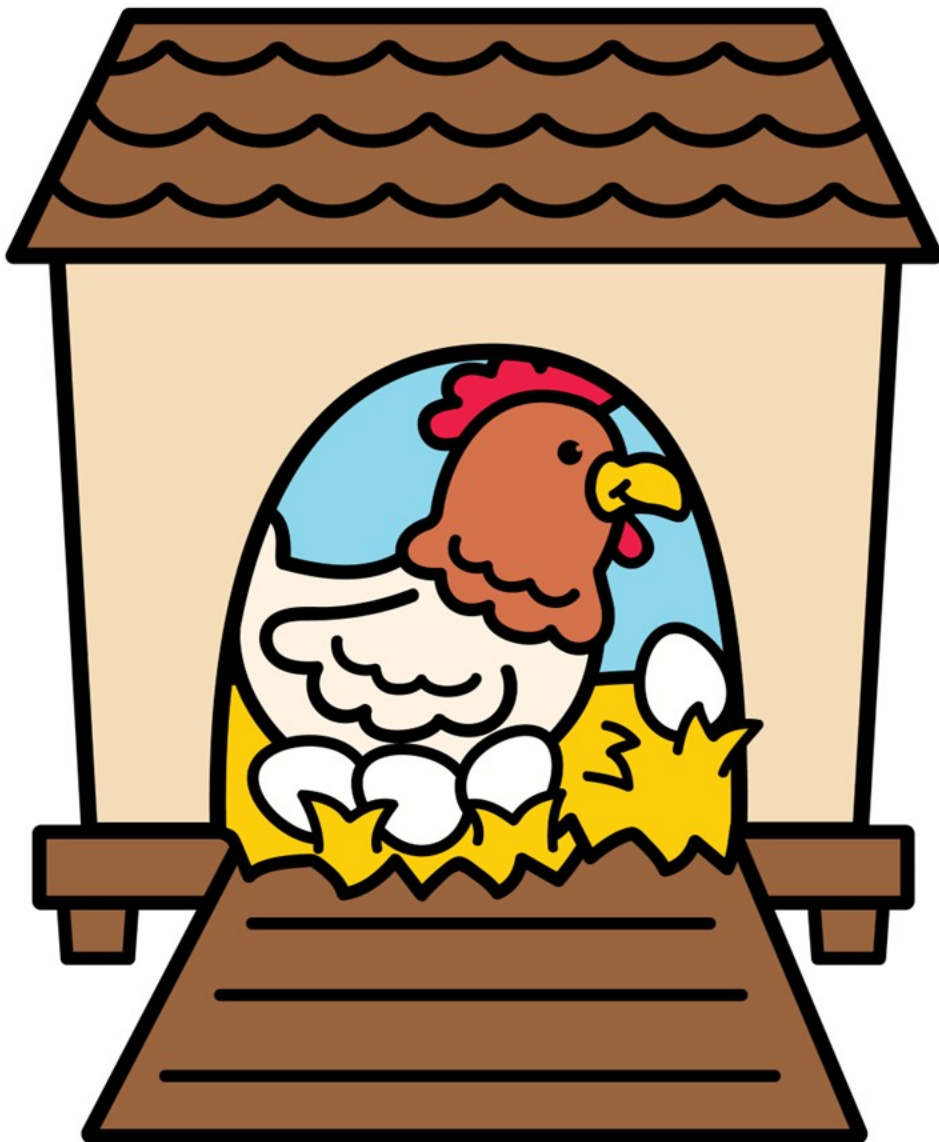

Pay Here



Shop Local



Support Local Farmers Banner

Print up on white card stock.

Laminate.

Trim.

Using a small dowel, fold on dotted line, place dowel between crease and tape over.

Place in farmer's market.

Fold banner on dotted line, place dowel in between crease and tape closed.

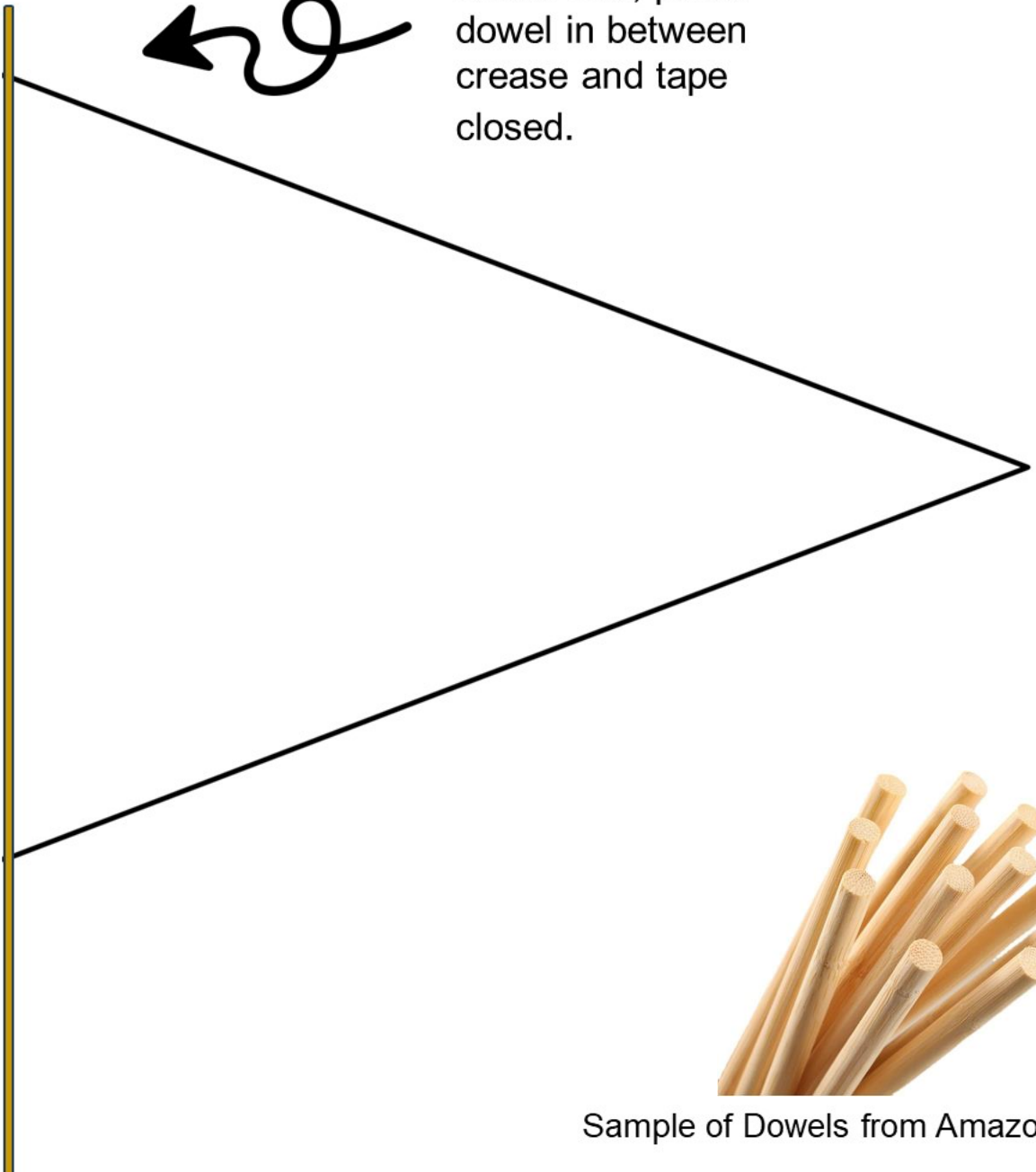

Sample of Dowels from Amazon

Support Local Farmers!



123 Learn Curriculum

Cucumbers - \$1.00 ea

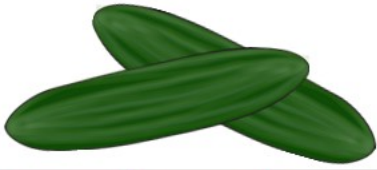

Corn on the Cob -
\$1.00 ea



Watermelon - \$4.50



Carrots



Head of Lettuce -
\$3.00



1 Dozen Eggs - \$2.50



Tomatoes - \$3.00 for 3

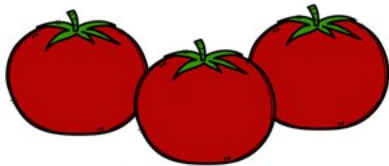

Peppers - \$3.00 for 3



Bushel of Apples -
\$5.00



Pumpkin - \$5.00



Farm Roll and Cover



Supplies needed:

- White card stock
- Laminating sheets
- 2 dice
- Small disks, play doh, pom poms or other item for covering numbers.



Directions:

- Print up a sheet for each child.
- Laminate.
- Have children take turns rolling dice and cover the number on their card with a pom pom or other items.
- Have children shake dice until done.

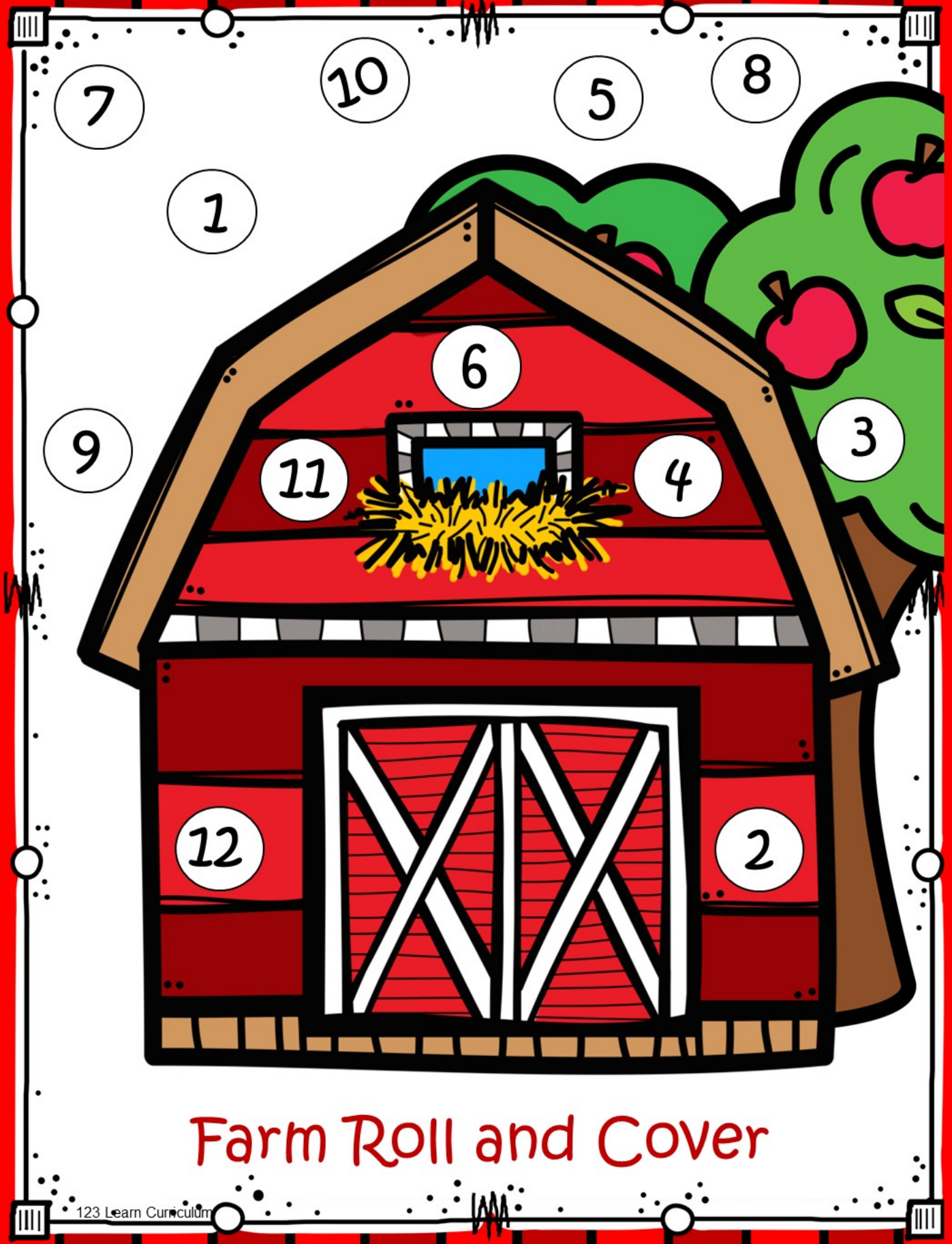

Farm Roll and Cover



Farm Roll and Cover

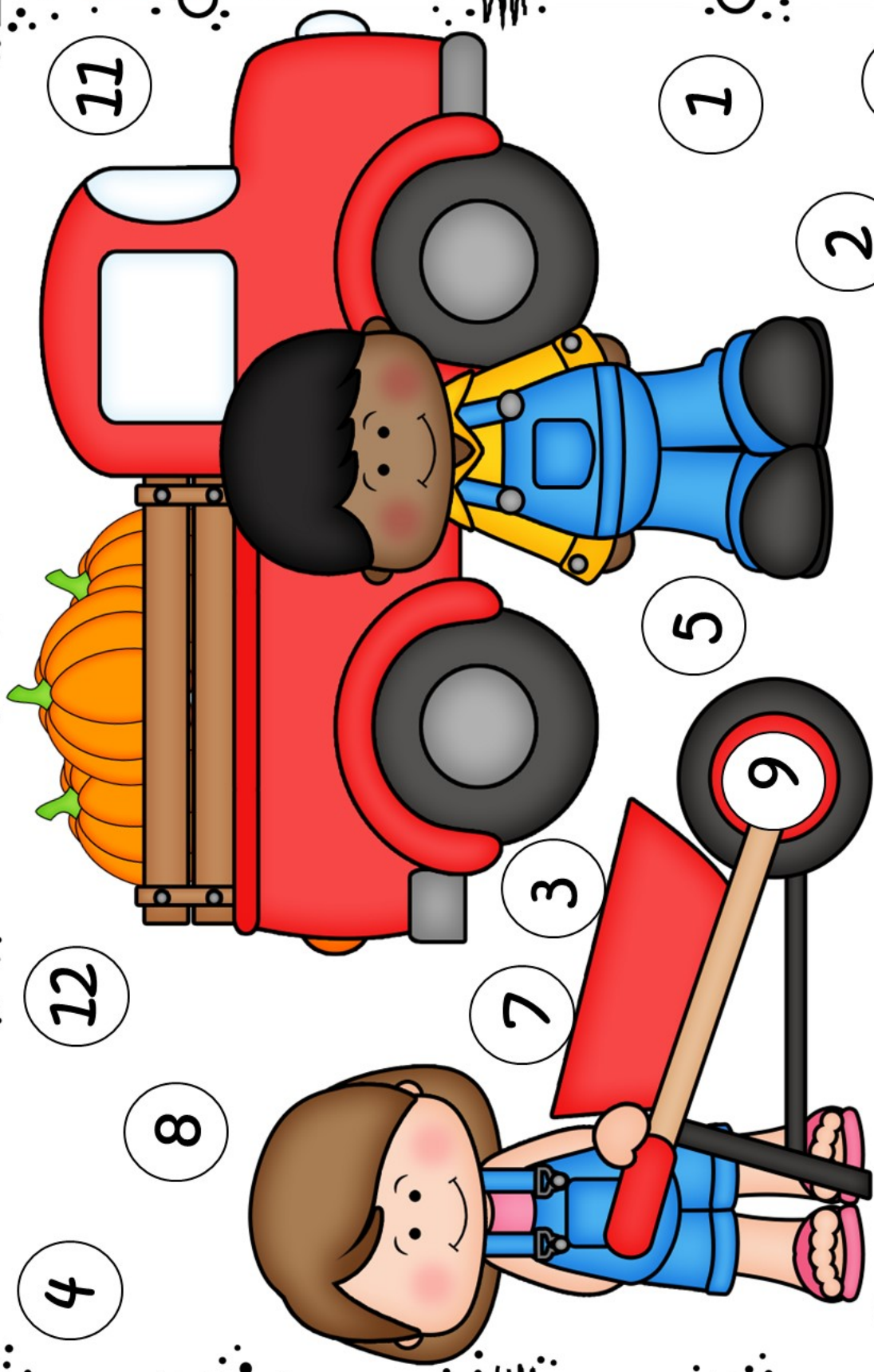

Farm Roll and Cover

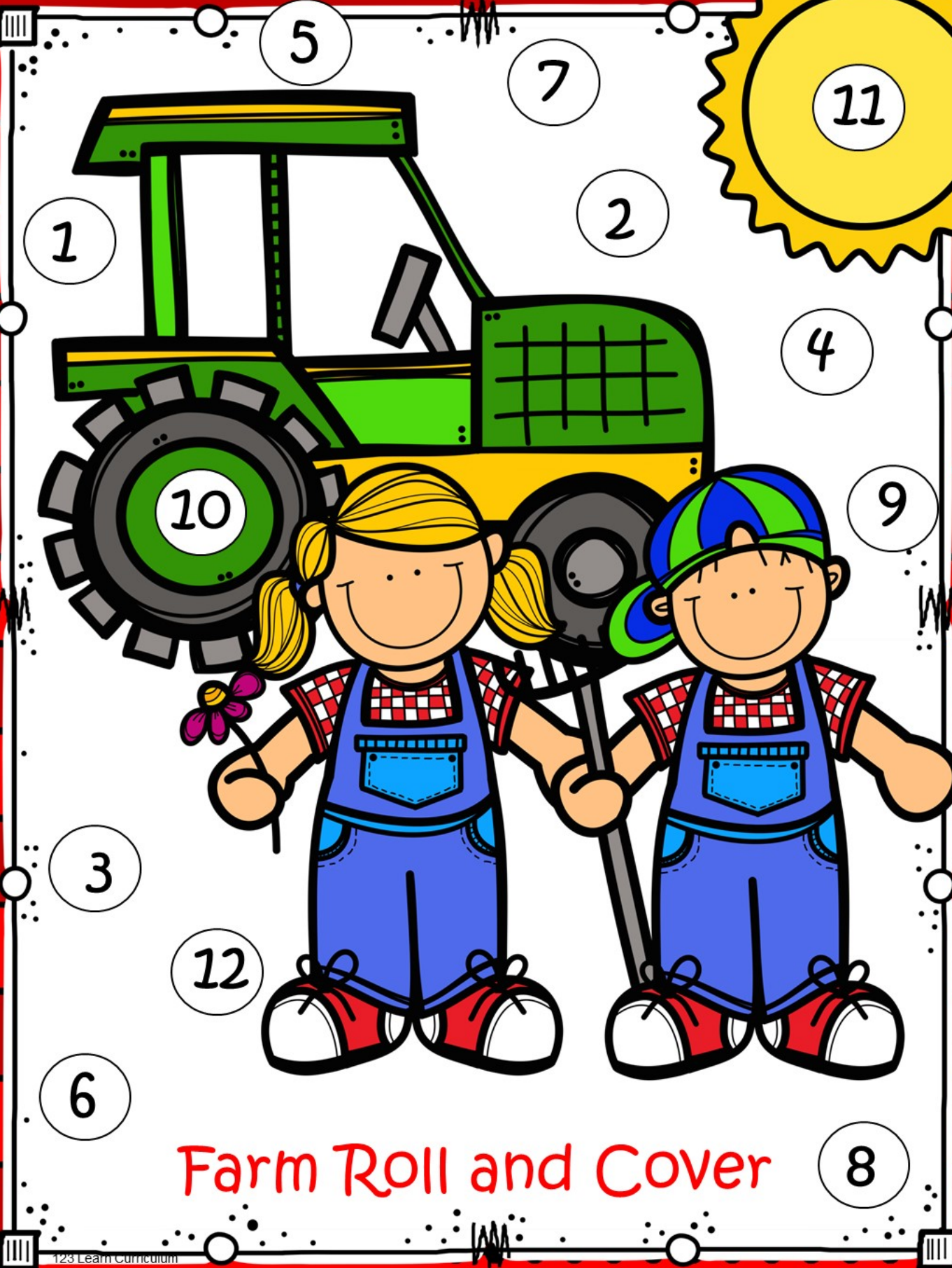

Farm Roll and Cover

Roll and Cover Sheets

Print up on white card stock.

Have children shake dice and color number.

Winner is 1st one who covers the sheet.

Color sheet when done.

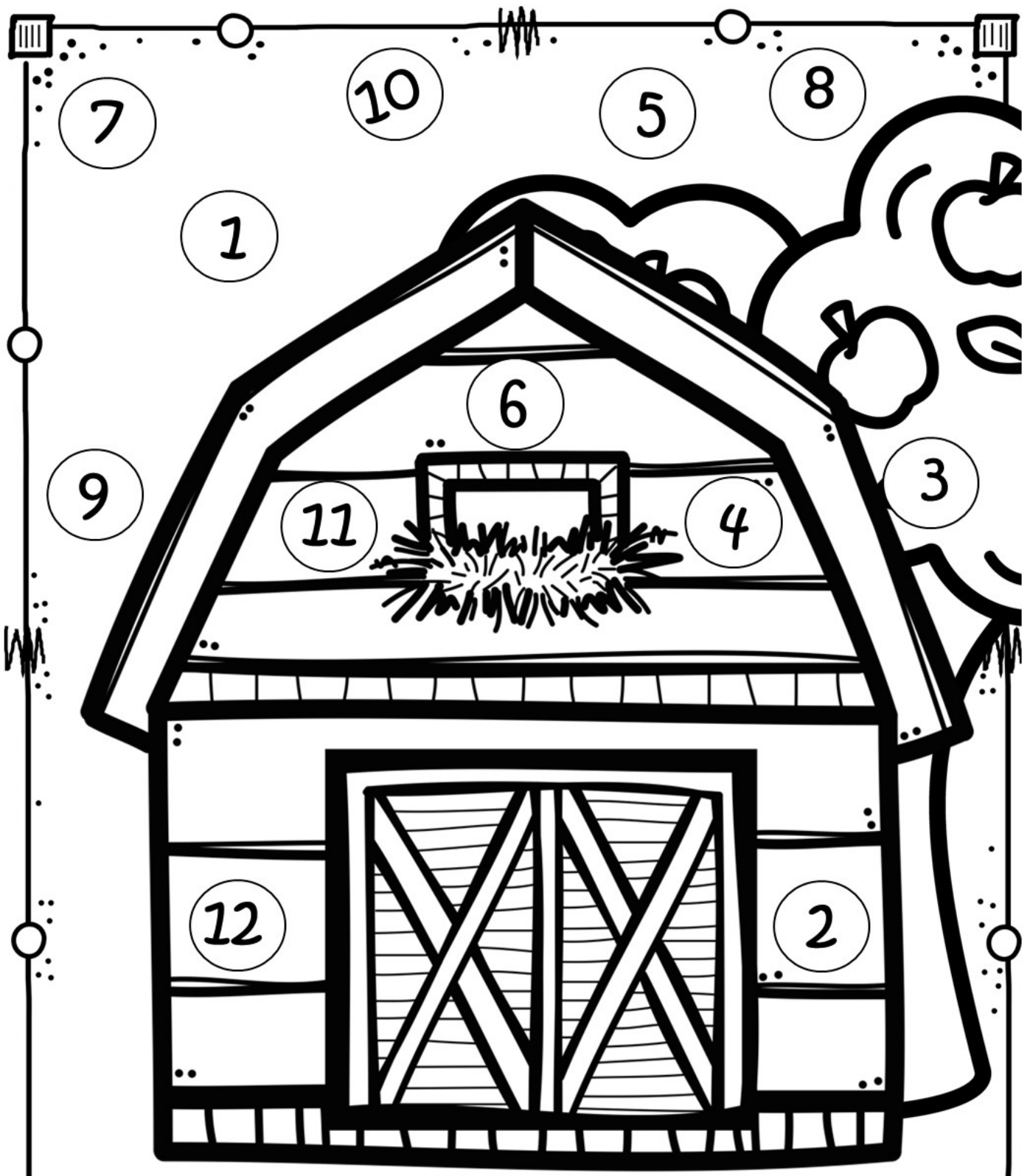

Farm Roll and Cover

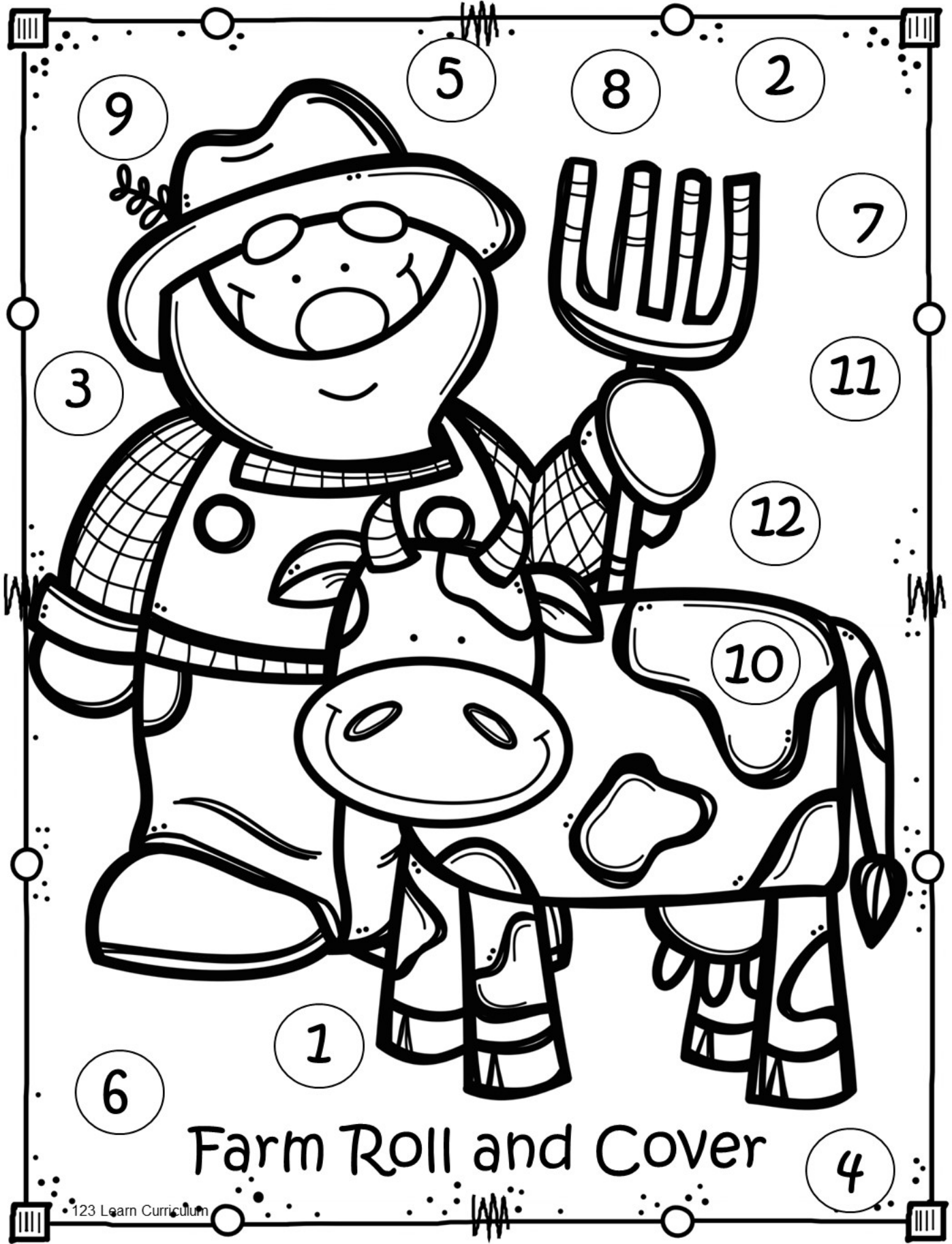

Farm Roll and Cover

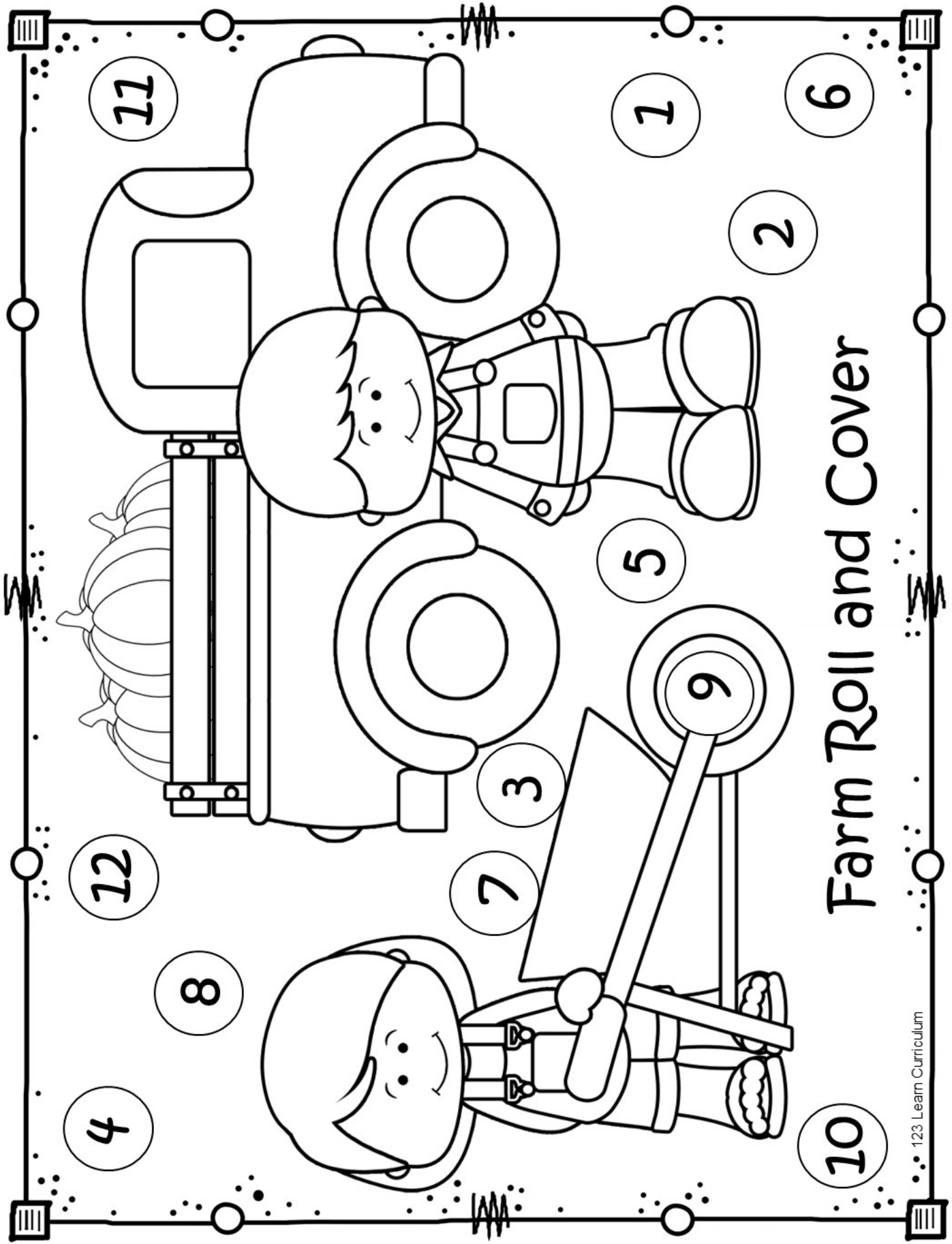

11

1

6

2

5

12

3

Farm Roll and Cover

4

7

9

8

10

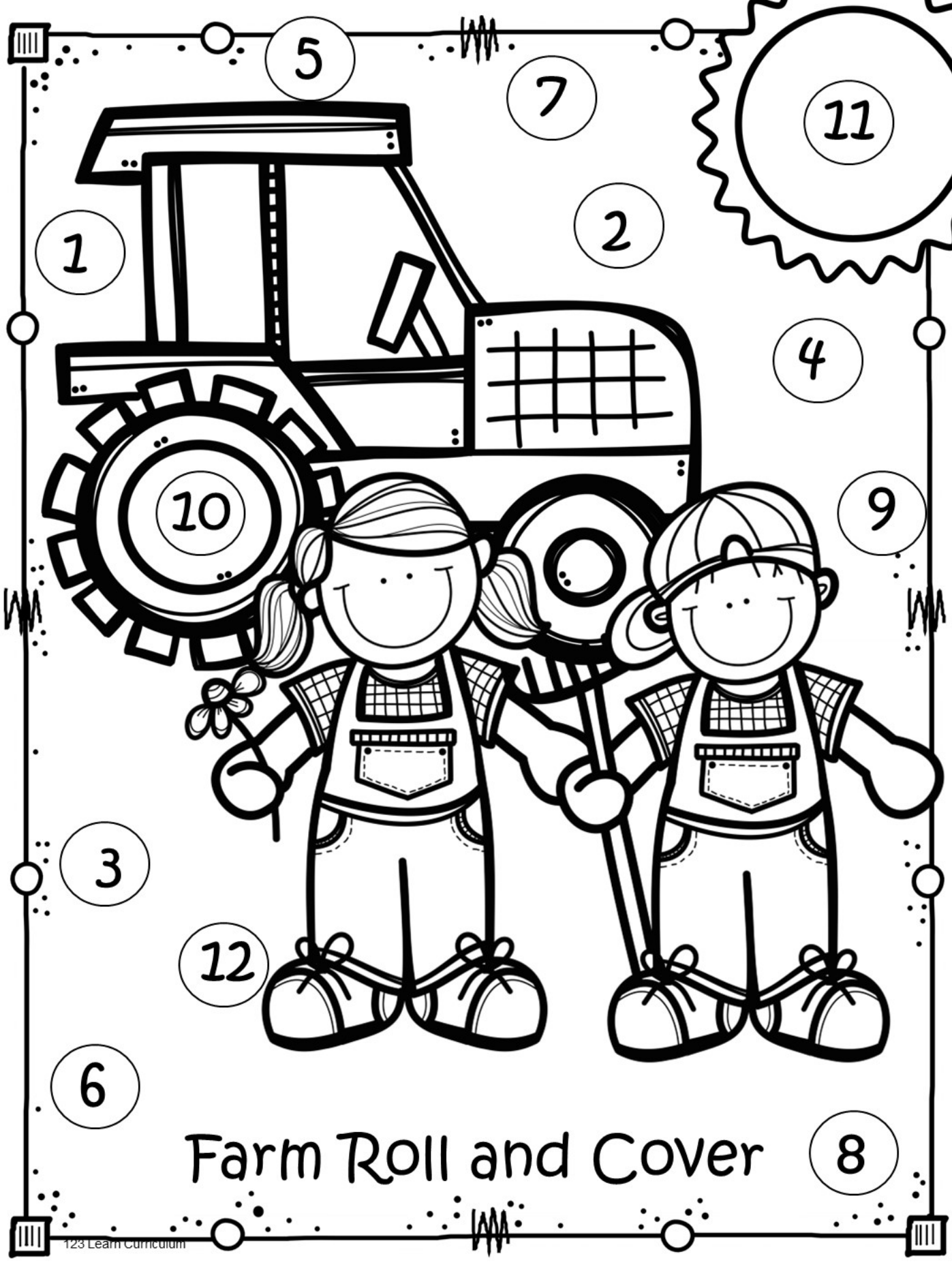

Farm Roll and Cover

Print up the following barn pictures on white card stock. Use pictures for art center. Decorate barns.

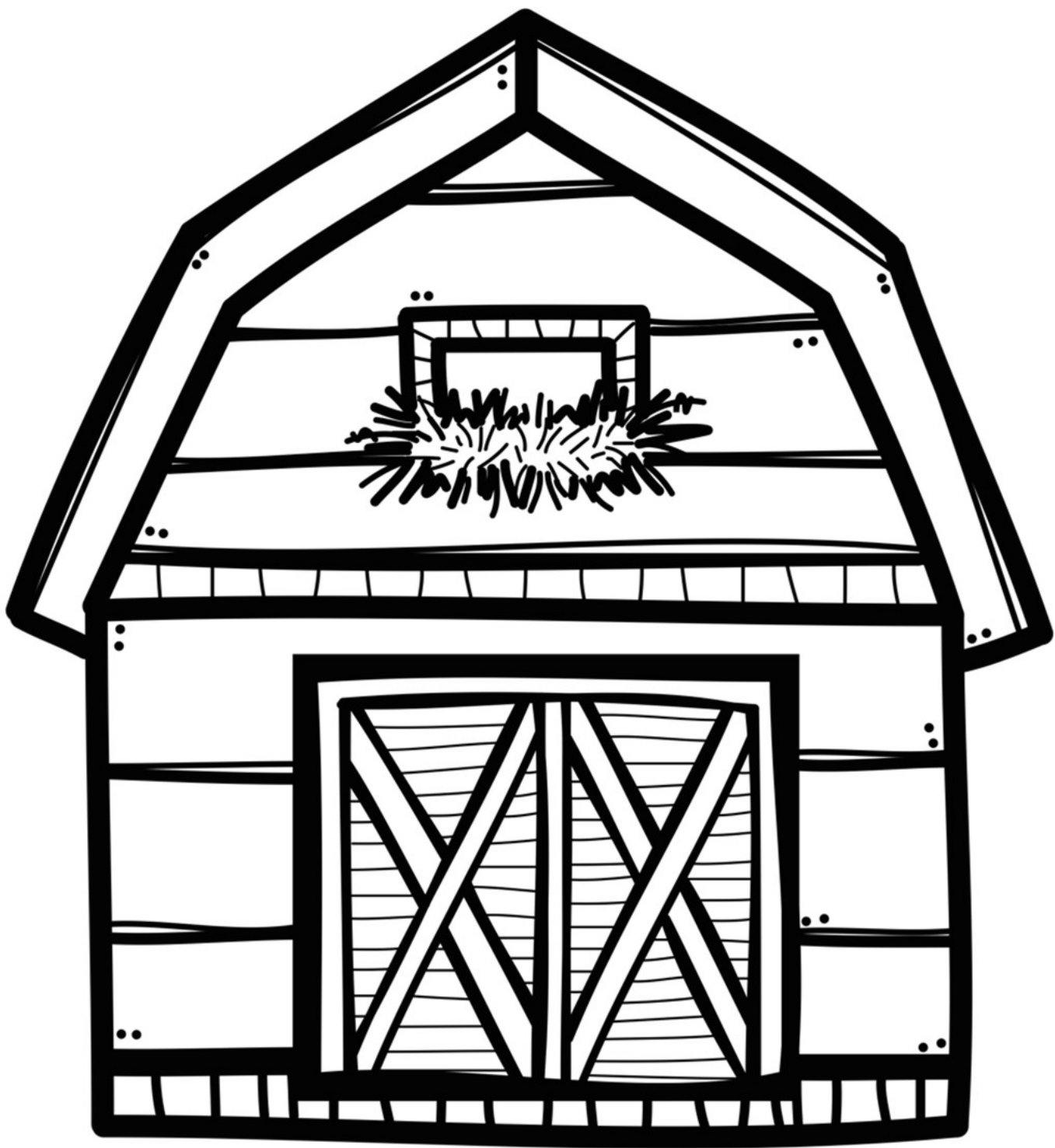

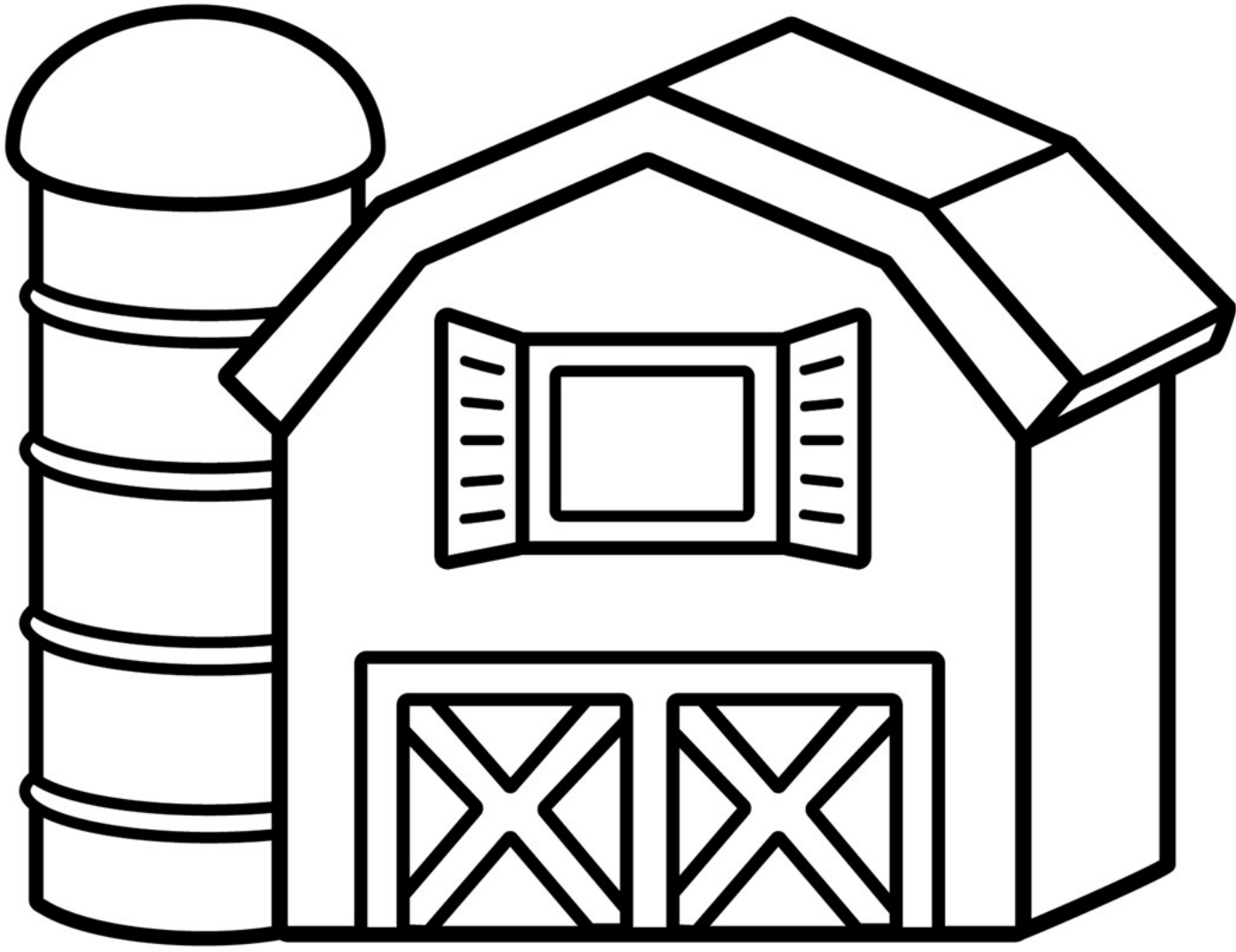

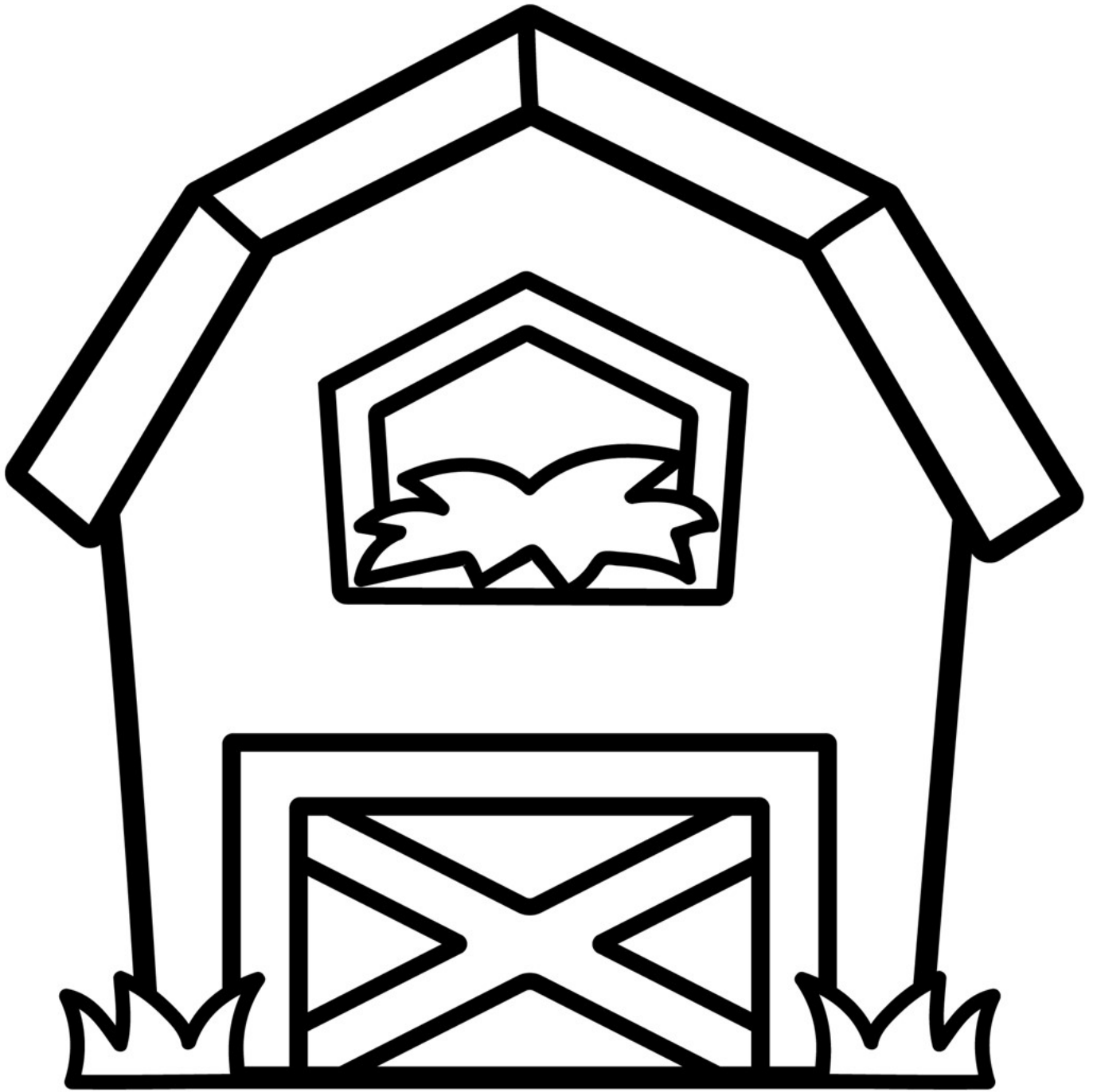

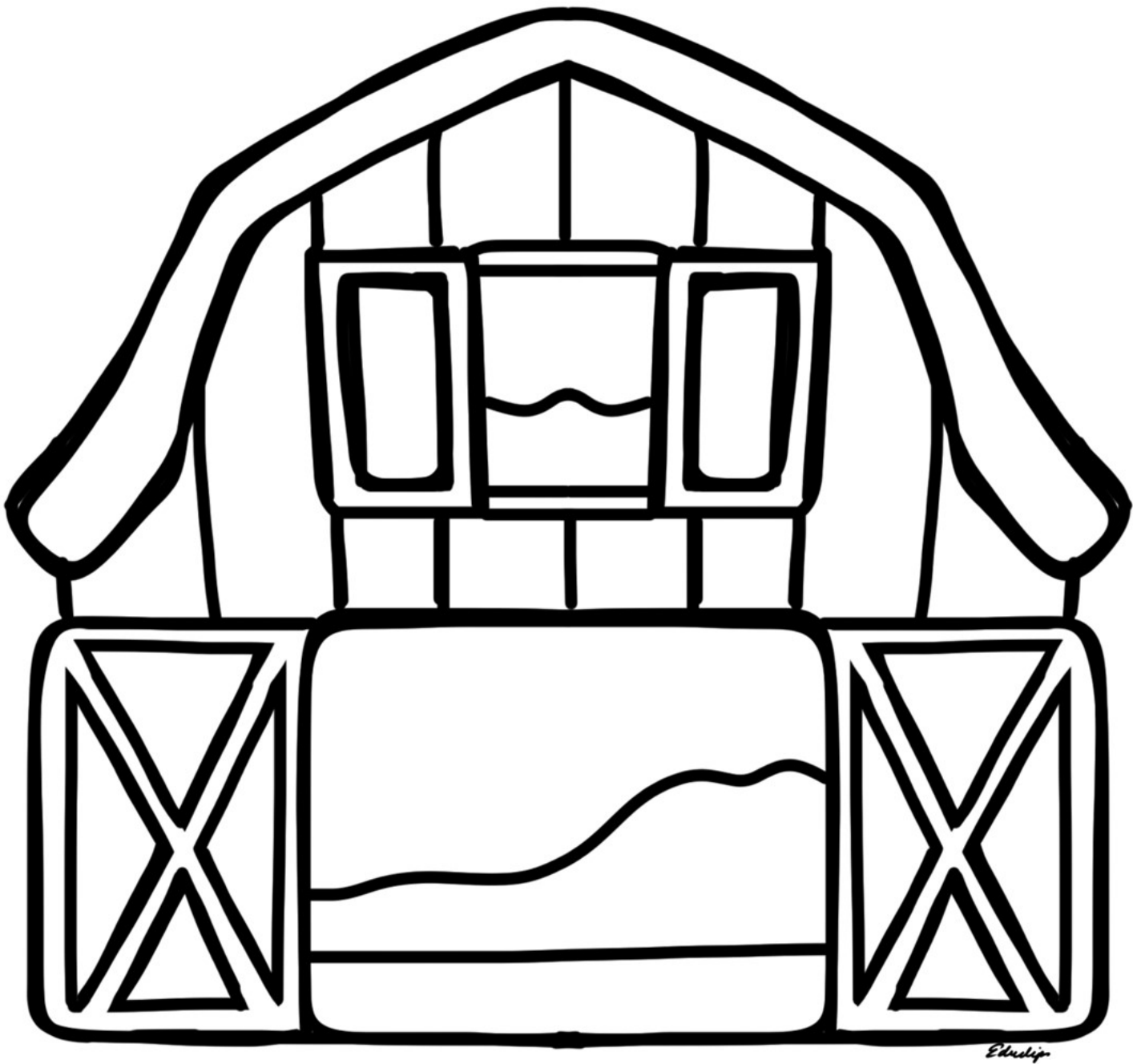

Edupix

Have children pick a word that they would like to practice writing.

Children will spin the spinner. Whatever the spinner lands on, (crayon, marker, highlighter or pencil), they will write the word on the paper in one of the spaces provided.

Use any pages and add to their memory book.

Addition idea: Children love to use the spinner, so when they get done writing the word, have them spin the spinner to see what they will color the picture with. Crayon, marker, highlighter or pencil.

Print up spinner on the following page onto white card stock on the following page. Cut out.
Attach spinner.

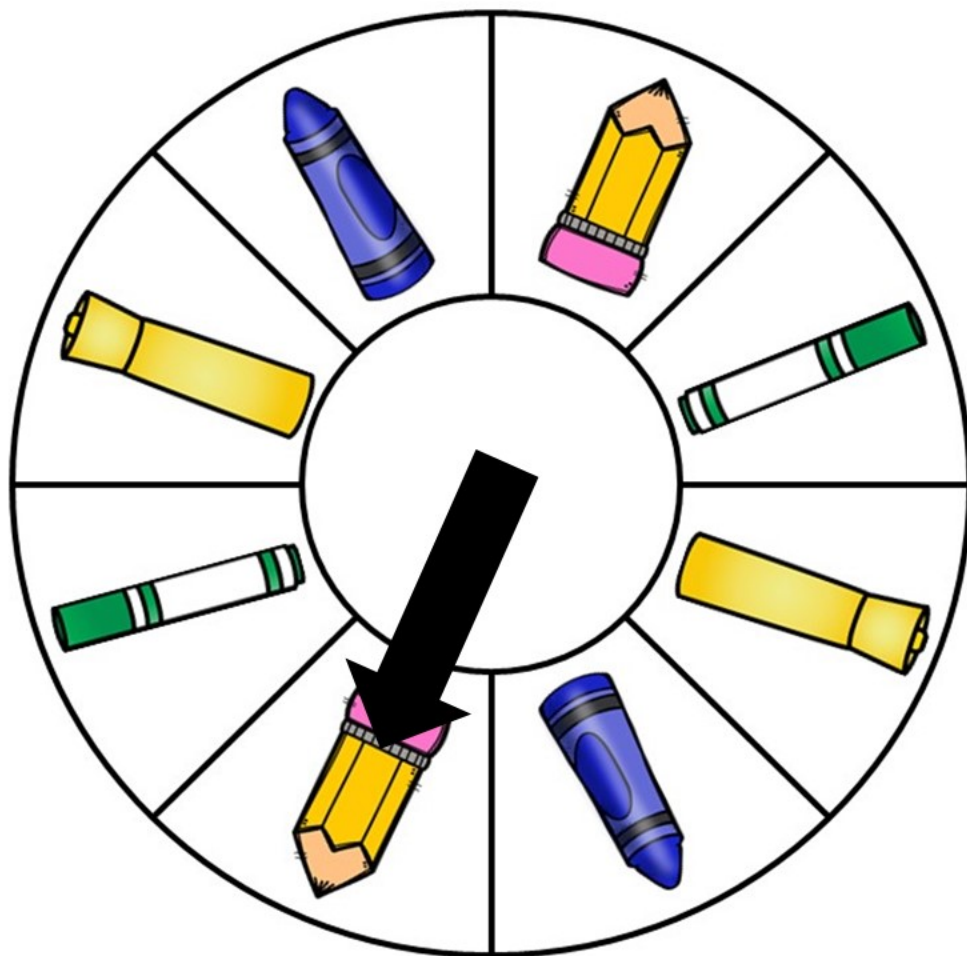

Arrow spinners can be purchased at

http://www.boardgamedesign.com/pages/go_shopping_2012/arrow_spinners.htm

(4" spinners)

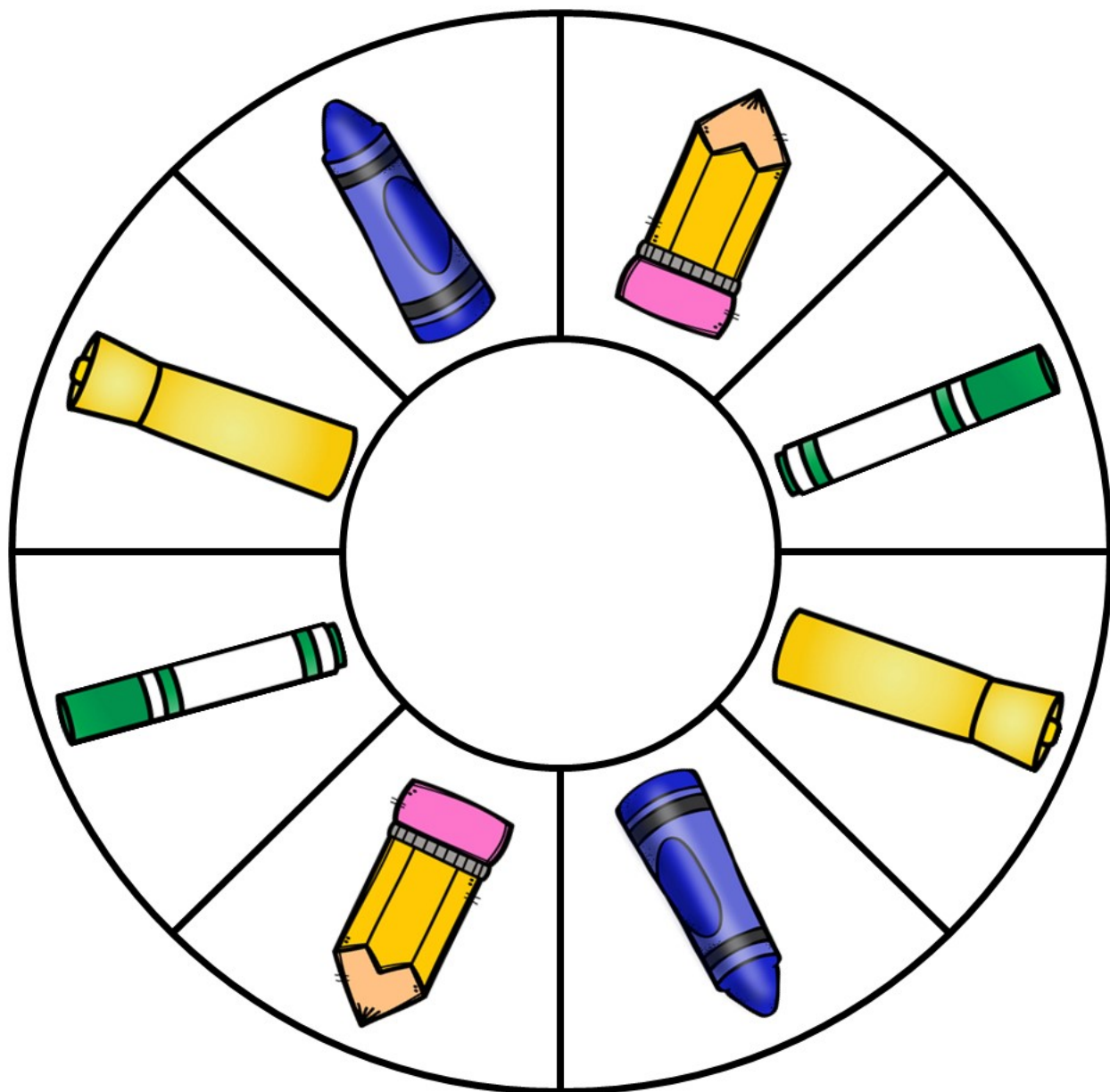

Name _____

Spin the wheel and write the word farmer with what the spinner lands on. Crayon, marker, pencil or highlighter.

farmer



Spin and Write

Name _____

Spin the wheel and write the word tractor with what the spinner lands on. Crayon, marker, pencil or highlighter.

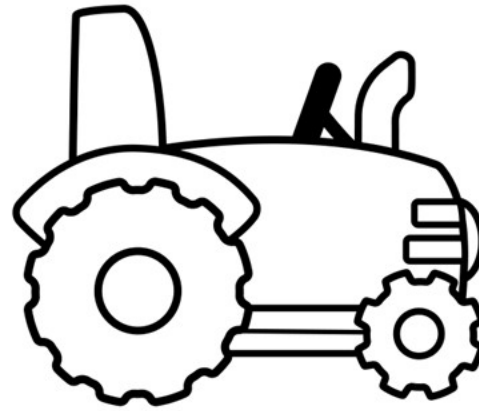

tractor

Spin and Write

Name _____

Spin the wheel and write the word barn with what the spinner lands on. Crayon, marker, pencil or highlighter.



barn

Spin and Write

Name _____

Spin the wheel and write the word cow with what the spinner lands on. Crayon, marker, pencil or highlighter.

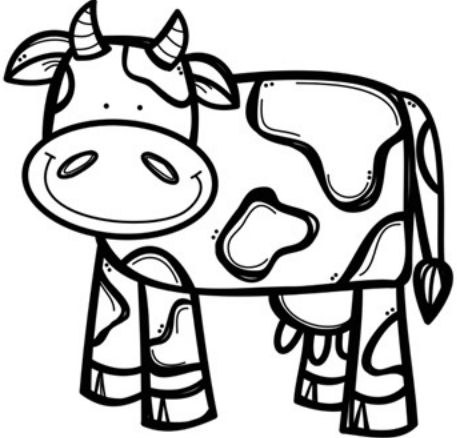
	
	COW

Spin and Write

Name _____

Spin the wheel and write the word silo with what the spinner lands on. Crayon, marker, pencil or highlighter.

silo

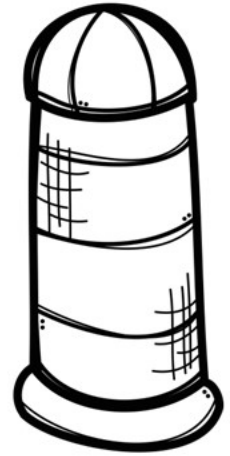

Spin and Write

Name _____

Spin the wheel and write the word milk with what the spinner lands on. Crayon, marker, pencil or highlighter.

	
	milk

Spin and Write

Name _____

Spin the wheel and write the word rooster with what the spinner lands on. Crayon, marker, pencil or highlighter.

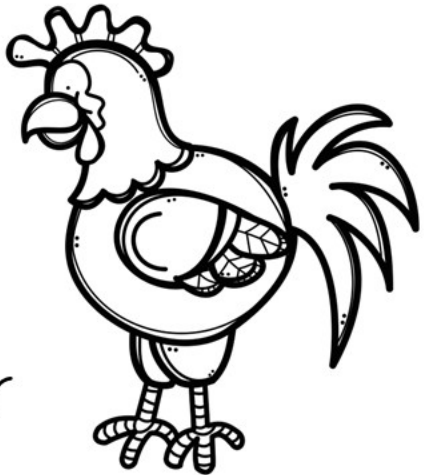
	
	rooster

Spin and Write

Name _____

Spin the wheel and write the word pig with what the spinner lands on. Crayon, marker, pencil or highlighter.



pig

Spin and Write

Name _____

Spin the wheel and write the word horse with what the spinner lands on. Crayon, marker, pencil or highlighter.

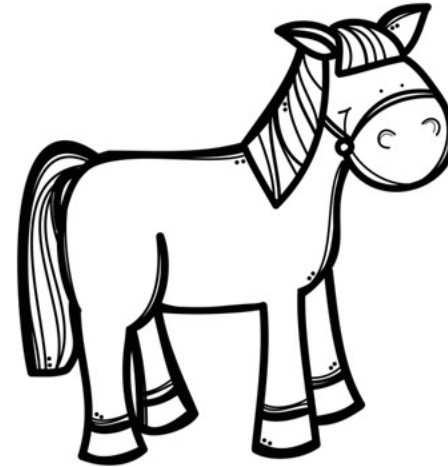

horse

Spin and Write

Name _____

Spin the wheel and write the word chick with what the spinner lands on. Crayon, marker, pencil or highlighter.

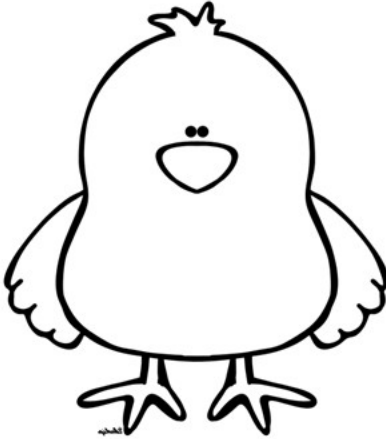
		chick

Spin and Write

Name _____

Spin the wheel and write the word
chicken with what the spinner lands on.
Crayon, marker, pencil or highlighter.

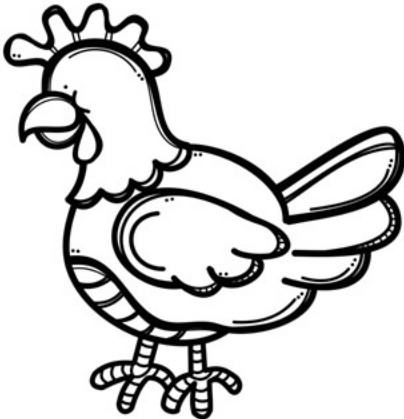
	chicken 

Spin and Write

Name _____

Spin the wheel and write the word goat with what the spinner lands on. Crayon, marker, pencil or highlighter.

goat

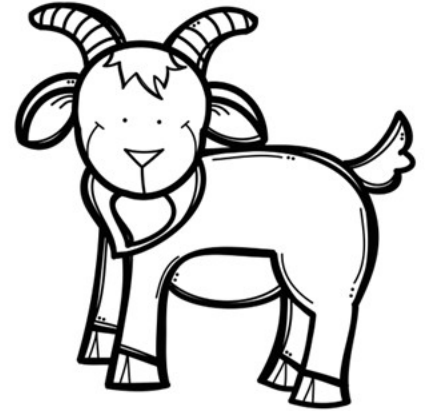

Spin and Write

Name _____

Spin the wheel and write the word sheep with what the spinner lands on. Crayon, marker, pencil or highlighter.

	sheep
	

Spin and Write

Name _____

Spin the wheel and write the word dog with what the spinner lands on. Crayon, marker, pencil or highlighter.

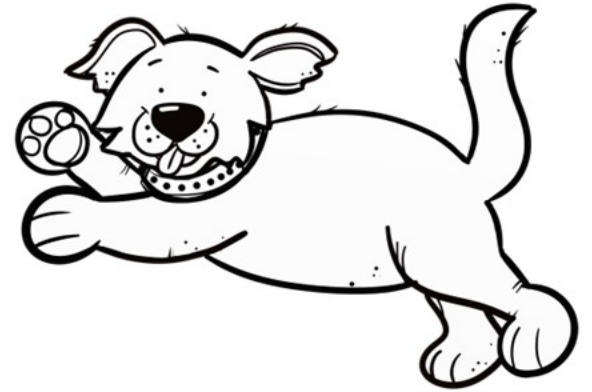

dog

Spin and Write

Name _____

Spin the wheel and write the word cat with what the spinner lands on. Crayon, marker, pencil or highlighter.

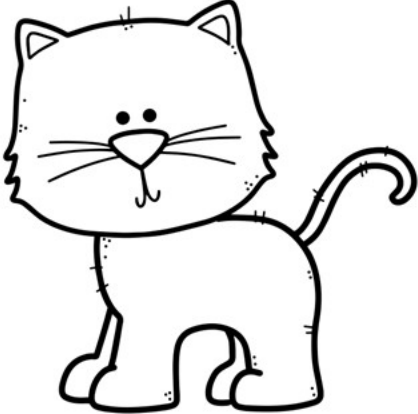
	cat 

Spin and Write

Name _____

Spin the wheel and write the word rabbit with what the spinner lands on. Crayon, marker, pencil or highlighter.

	
	rabbit

Spin and Write

Name _____

Spin the wheel and write the word goose
cane with what the spinner lands on.
Crayon, marker, pencil or highlighter.

g o o s e



Spin and Write

Name _____

Spin the wheel and write the word coop with what the spinner lands on. Crayon, marker, pencil or highlighter.

	
	coop

Spin and Write

Name _____

Spin the wheel and write the word egg with what the spinner lands on. Crayon, marker, pencil or highlighter.

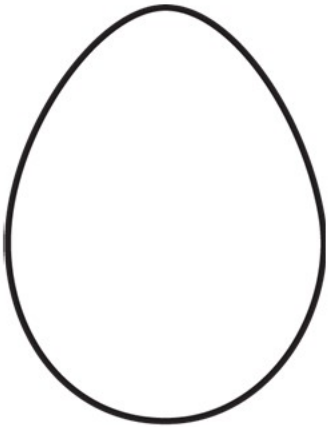
	 egg

Spin and Write

Name _____

Spin the wheel and write the word corn with what the spinner lands on. Crayon, marker, pencil or highlighter.

	corn 

Spin and Write

Name _____

Spin the wheel and write the word fence with what the spinner lands on. Crayon, marker, pencil or highlighter.

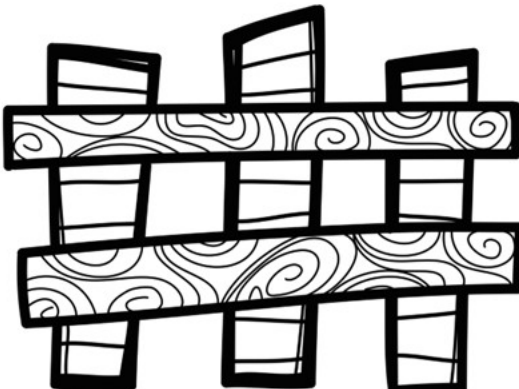
	fence 

Spin and Write

Name _____

Spin the wheel and write the word truck
Pole with what the spinner lands on.
Crayon, marker, pencil or highlighter.

truck



Spin and Write

Name _____

Spin the wheel and write the word hay with what the spinner lands on. Crayon, marker, pencil or highlighter.

	
	hay

Spin and Write

Name _____

Spin the wheel and write the word carrots with what the spinner lands on. Crayon, marker, pencil or highlighter.

carrots

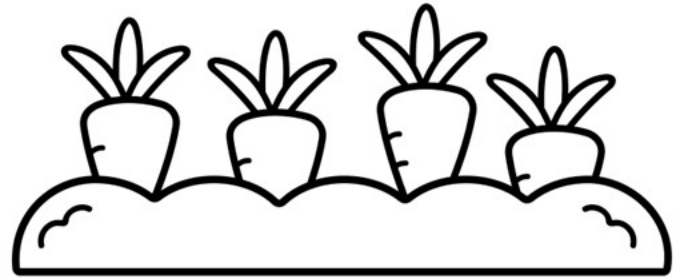

Spin and Write

Name _____

Spin the wheel and write the word
vegetables with what the spinner lands
on. Crayon, marker, pencil or highlighter.



vegetables

Spin and Write

Name _____

Spin the wheel and write the word fruit with what the spinner lands on. Crayon, marker, pencil or highlighter.

	 fruit

Spin and Write

The Floating Egg

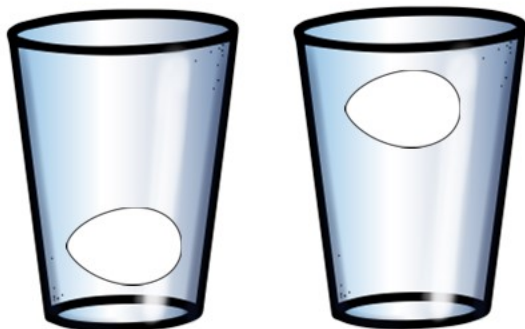

Directions:

This experiment has to do with the difference in density between pool water and salt water. Salt water is denser than pool water and this experience will give children a visual of why this happens.

Density is defined as mass per unit of volume. If you were to weigh 1 cubic cm of pool water and 1 cubic cm of ocean water, you would find that the ocean water weighs more.

- Gently place an egg into the first glass of water. Does it sink or float? (It should sink).
- Add about 6 tablespoons of salt to the second glass of water. Stir until the salt dissolves.
- Gently place the second egg into the glass of salt water. Does it sink or float? (It should float. If it doesn't, add more salt to the water).

Ask children before placing each egg in the water if it will float or sink. Write down each guess.

Supplies needed:

- 2 glasses of water
- 2 eggs
- Stirring spoon
- 1 tablespoon
- Salt



The Floating Egg

Egg # 1		
Name	Float	Doesn't Float

Egg # 2		
Name	Float	Doesn't Float

Print up farm structures, laminate and hand up in block center.

I Can Build a
Barn

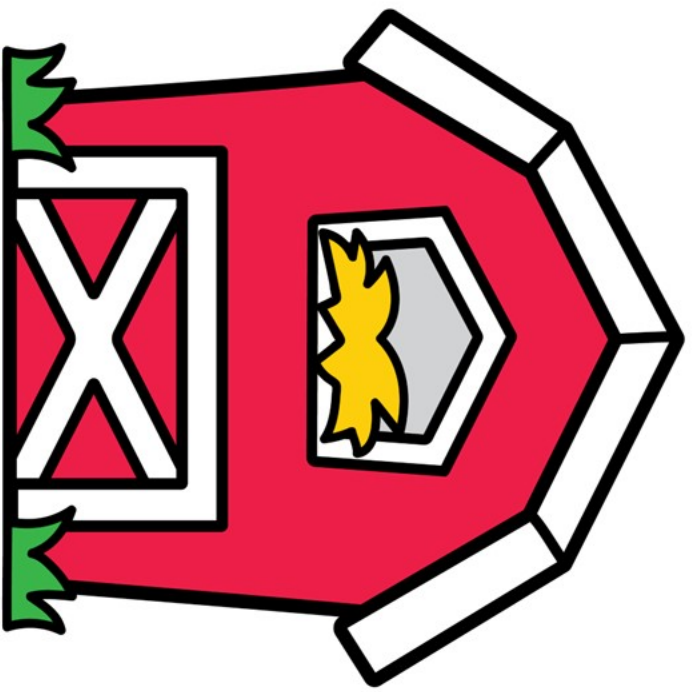

I Can Build a
Silo

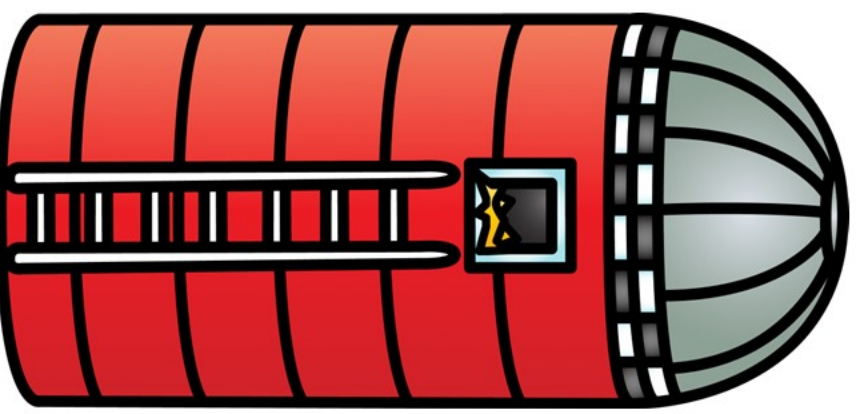

I Can Build a
Chicken Coop

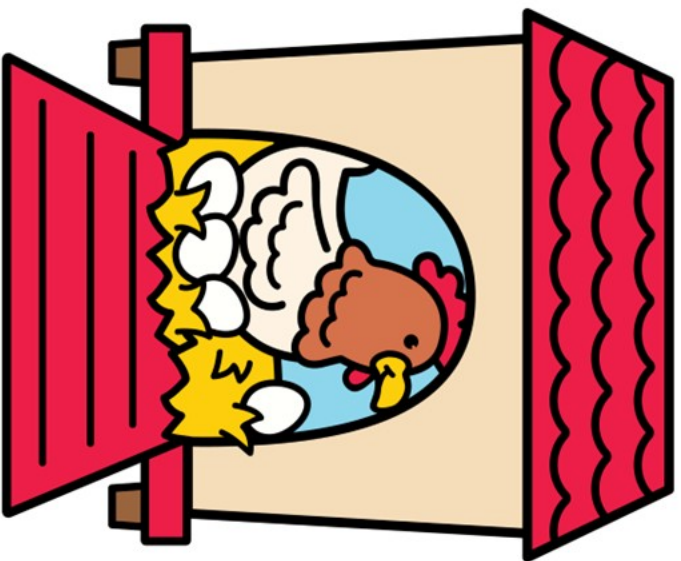

I Can Build a
Farm House

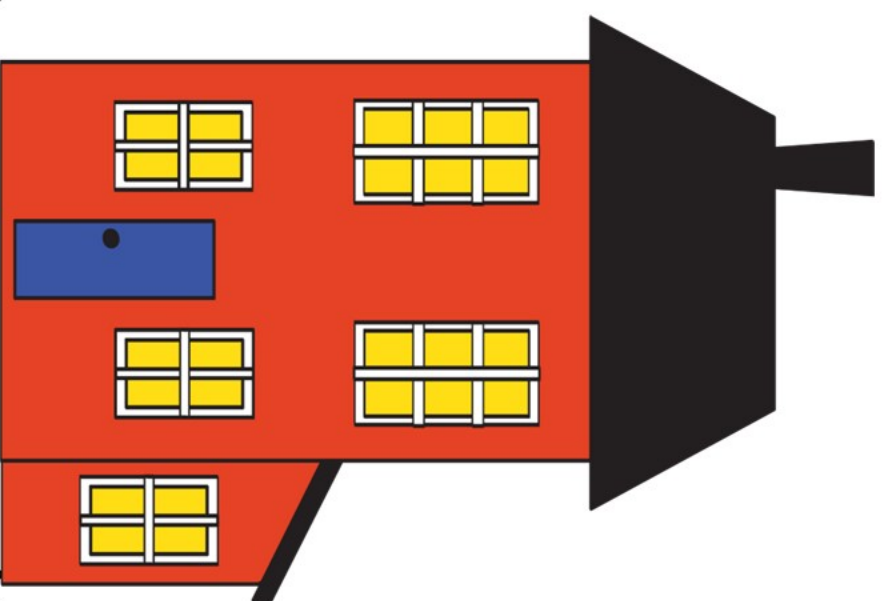

Organizing your Preschool Activities

Planning how you will organize your preschool activities can be as easy and simple as you want it to be. Do you want it to be easier to access? The following pages and pictures will show you a way to organize and have it easily accessible to you when you do the down on the farm theme.

There will be pictures and links to purchase folder and pocket folders. This is the way I am personally putting together my weekly themes. Take these ideas and shop your local Target, or other stores to find items that will work in your organization of your theme.

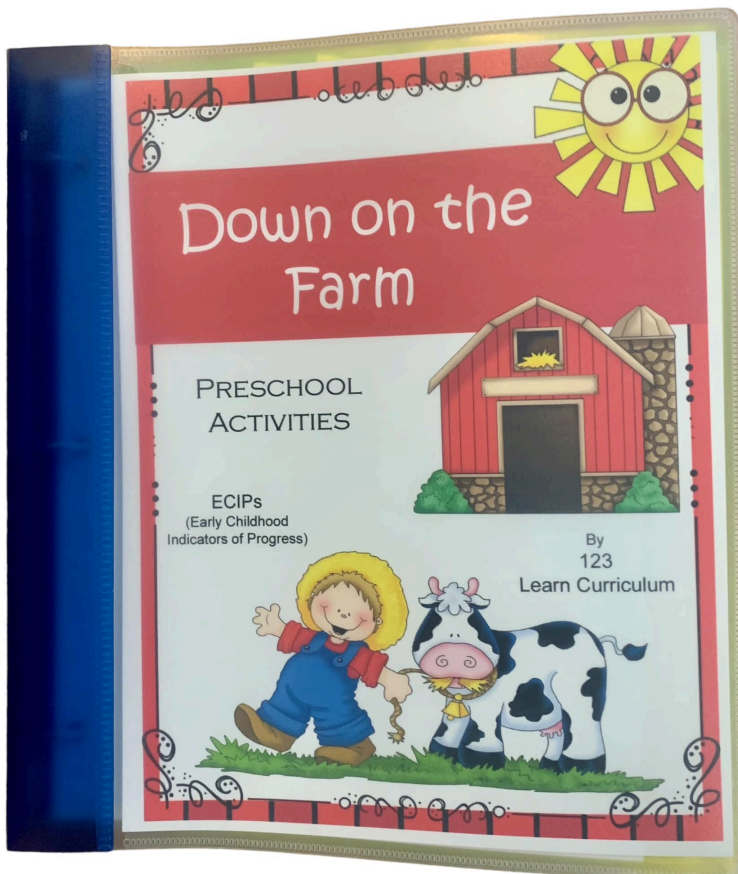

Down on the farm preschool activities are stored in a 3-ring binder. 1". Sample shows an Avery flexible binder.

This 3-ring binder was purchased online at [Amazon.com](https://www.amazon.com).

To purchase, click on picture.

Page to add to the front of your 3-ring binder.
Print on white card stock.

Trim the white edge off and place in the front
of the 3-ring binder.



Down on the Farm

PRESCHOOL ACTIVITIES



ECIPs
(Early Childhood
Indicators of Progress)

By
123
Learn Curriculum



Print up the 1st page of each activity in the preschool lesson plan using white card stock. Using a 3-hole punch, punch holes in the sheet and add to the 3-ring binder.

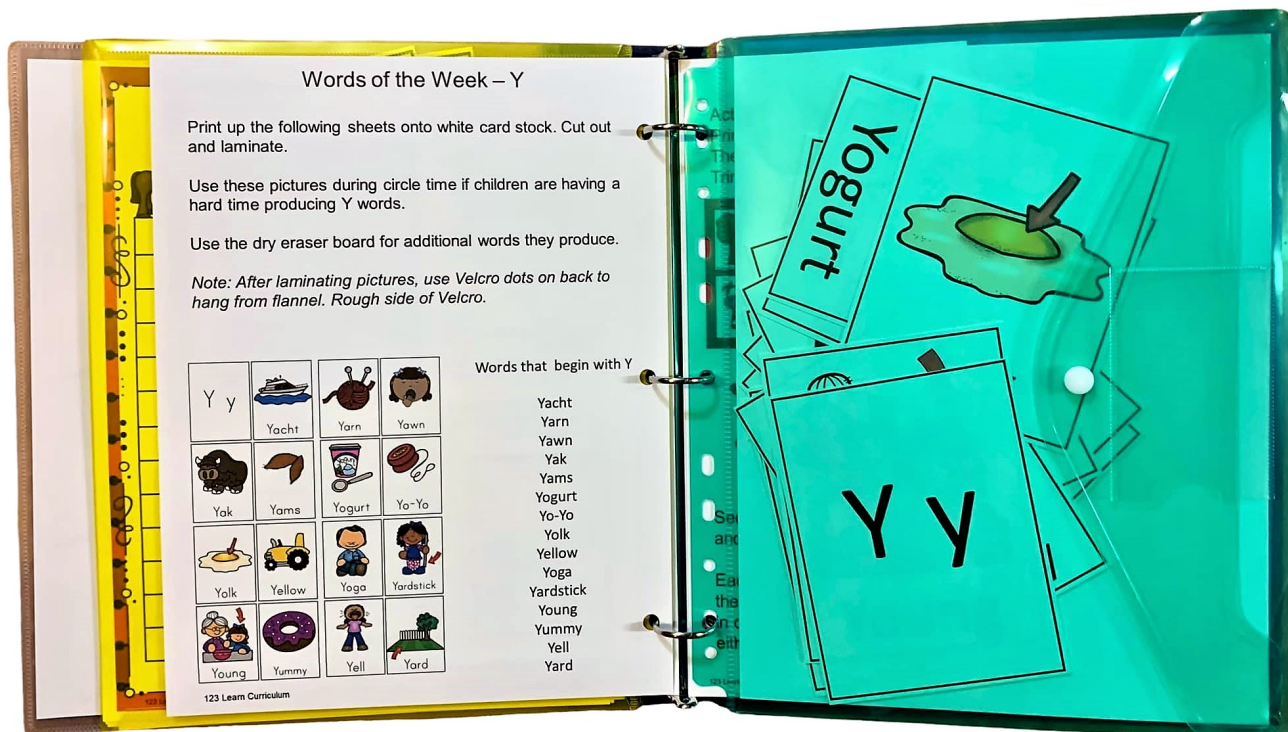

You can do a search on Amazon for a 3-ring punch.

Click on picture to purchase the one shown.

Print up activities in the preschool section and after laminating and cutting out, place in a binder pocket. Using pockets with Velcro closures will keep items from slipping out.

All items from the preschool lesson plan will fit into a 1" ring binder. The flexible covers are used because they are what it states... Flexible. 😊



Click on picture to purchase from Amazon.com.

I receive no compensation for promoting items on amazon.com.

You can save on pocket envelopes by placing a piece of white card stock in the envelope before adding items. Place items for 2 separate activities on both sides of the card stock.

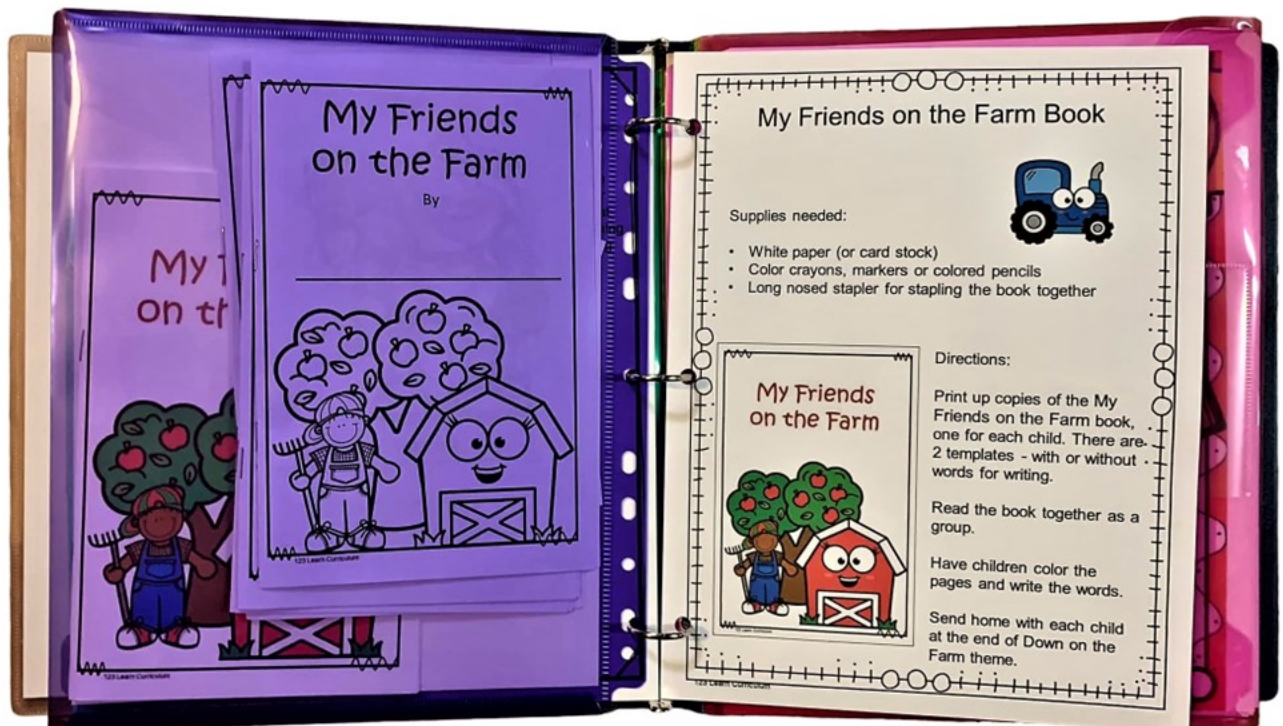

The pictures and links are only an example of what you could do to make it easier to organize your preschool lesson plan. There are links for resources to purchase, but you can also visit your local Target or office supply store and see what they have available, and if this would work for you.

As always, any feed back would be appreciated, or finished pictures of your lesson plan. JeanieB506@aol.com

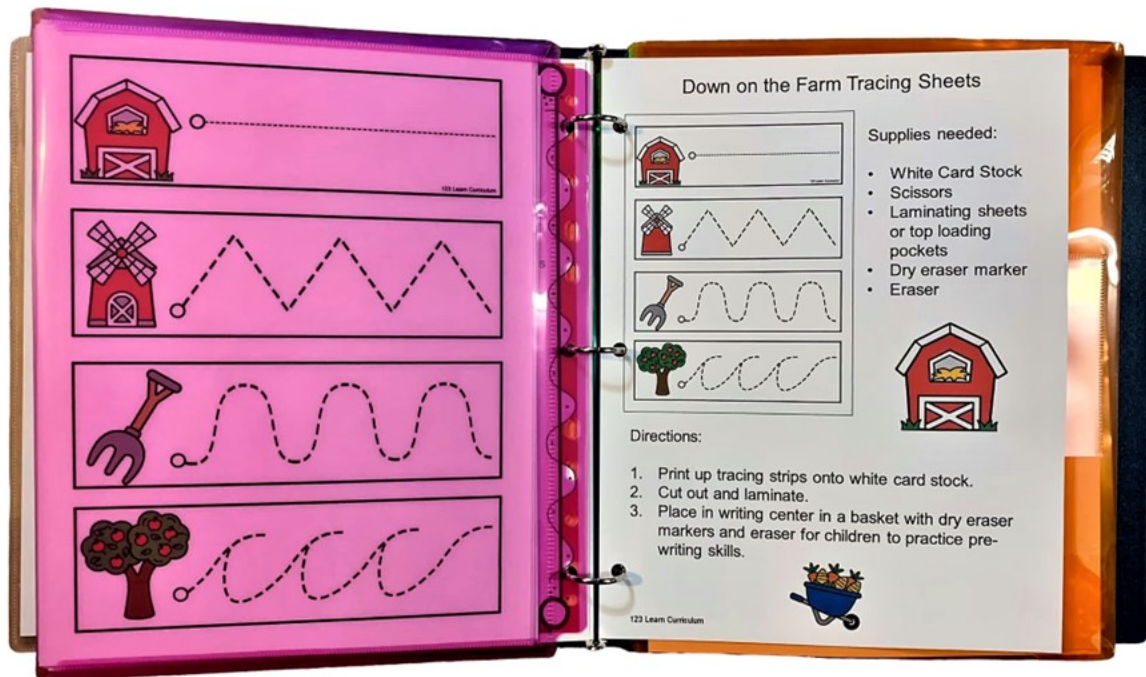

Label for Bin

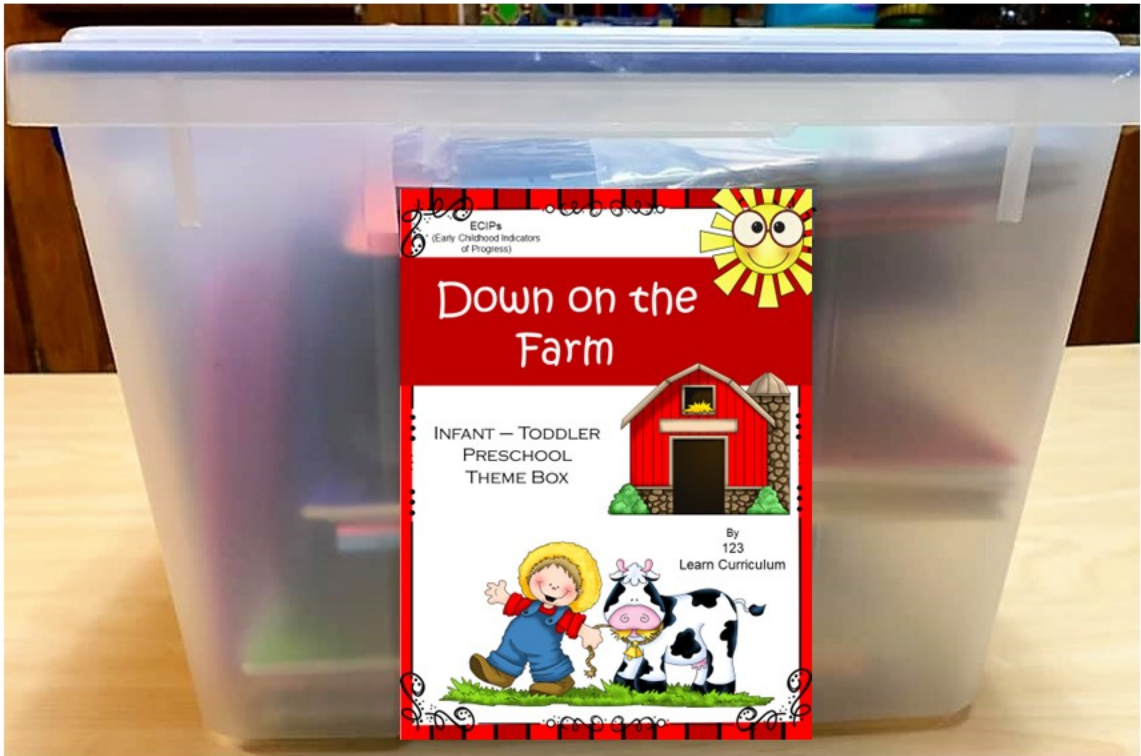

The following sheet is printed on self-adhesive full sheet labels. Once printed, cover with a self laminating sheet and trim.

Remove adhesive paper from the back of the label and attach to the container.

Putting a self laminating sheet over the label before trimming will protect the ink and it won't fade or rub off.

Samples of items to purchase from Amazon, but you can look at your local office supply store for identical items. Click on picture to purchase from Amazon.



Full Sheet Self Adhesive Shipping Labels

Avery 73601 Self-Adhesive Laminating Sheets, 9 x 12 Inch, Permanent Adhesive, 50 Clear Laminating Sheets

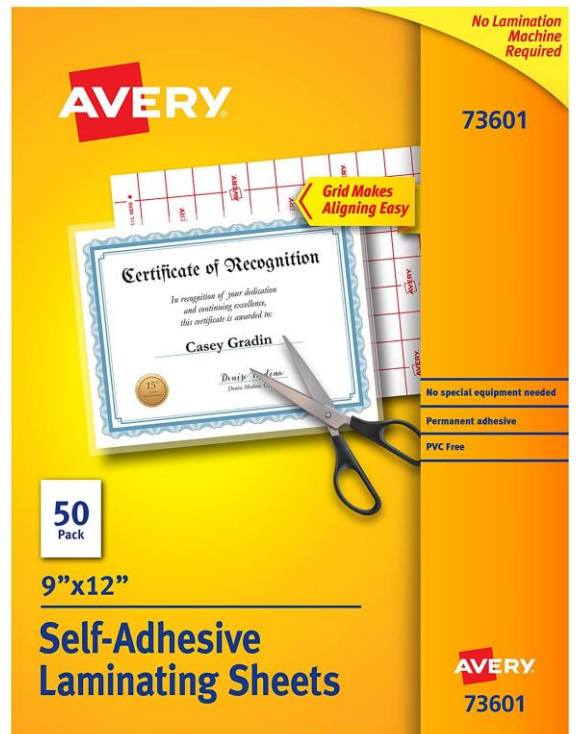

ECIPs
(Early Childhood Indicators
of Progress)



Down on the Farm

INFANT – TODDLER
PRESCHOOL
THEME BOX



By
123
Learn Curriculum



ECIPs
(Early Childhood Indicators
of Progress)



Down on the Farm

INFANT – TODDLER
PRESCHOOL
THEME BOX



By
123
Learn Curriculum





Down on the Farm

INFANT – TODDLER
PRESCHOOL
THEME BOX



By
123
Learn Curriculum



Smaller label for smaller bin or use shipping label and type in Down on the Farm.

Family Notes and Notes Home



- **Family Notes.** Print up and send home with each child the Friday before you start the down on the farm theme.
- **Blank Notes.** Additional notes for you to use and send home during this theme. They are in the format of Childcare, Day Care or Preschool, depending on what term you use. Use the appropriate note and print up. Write your note and send home with children

Family Notes and Notes Home

You have 2 options when using the family notes and notes home.

- Print up - write directly onto them, make copies and hand out.
- Bring up form you would like to use. The templates can be typed directly onto the form in the blue boxes. Type in the blue boxes and print up. You will not be able to save the data, so make sure you do all the typing needed and print up.

When printing, the blue boxes will not show up.

Dear Family,



Next week, our theme is Down on the Farm. During this time, if you have any books or DVD's that are theme related that you would like to share, please feel free to bring them.

The color for this theme is pink. Please help your child locate something to bring or wear for Color Day on _____.

We will also learn about the number 4, shape triangle and letter Y.

Thank you

Dear Family,



Next week, our theme is Down on the Farm. During this time, if you have any books or DVD's that are theme related that you would like to share, please feel free to bring them.

The color for this theme is pink. Please help your child locate something to bring or wear for Color Day on _____.

We will also learn about the number 4, shape triangle and letter Y.

Thank you

A Note From Childcare



A Note From Childcare





A Note From Child Care



A Note From Child Care

A Note From Childcare



A Note From Childcare



A Note From Day Care



A Note From Day Care





A Note From Day Care



A Note From Day Care

A Note From Day Care



A Note From Day Care



A Note From Preschool



A Note From Preschool





A Note From Preschool



A Note From Preschool

A Note From Preschool



A Note From Preschool





Just a Reminder



Just a Reminder

Just a Reminder



Just a Reminder





Just a Reminder



Just a Reminder

WEEK IN REVIEW



WEEK IN REVIEW



WEEK IN REVIEW



Dear Family,

Just a reminder that tomorrow is Color Day. Our color for tomorrow is pink. You can have your child bring or wear something that is pink.

Thank you



Dear Family,

Just a reminder that tomorrow is Color Day. Our color for tomorrow is pink. You can have your child bring or wear something that is pink.

Thank you



Blank Sheets

The following pages have sheets that you can type directly onto and print. Just click in the blue boxes and type what you want and print up.

Blue boxes will not show up when you print.
2nd option: print up and write directly onto the sheet.

(Forms cannot be saved, so make sure you have time to fill out completely before you print up).

DOWN ON THE FARM



Art

Literacy

Manipulates

Fine/Gross Motor Skills

Math Skills

Sensory/Science



Music/Movement

Down on the Farm



Art

Literacy

Manipulates

Fine/Gross Motor Skills

Math Skills

Sensory/Science



Music/Movement

Down on the Farm



Art

Literacy

Manipulates

Fine/Gross Motor Skills

Math Skills

Sensory/Science



Music/Movement

Down on the Farm



Art

Literacy

Manipulates

Fine/Gross Motor Skills

Math Skills

Sensory/Science



Music/Movement

Blank Sheets

The following pages have sheets that you can type directly onto and print. Just click in the blue boxes and type what you want and print up.

Blue boxes will not show up when you print.

2nd option: print up and write directly onto the sheet.

(Forms cannot be saved, so make sure you have time to fill out completely before you print up)

Weekly Planner



Week of: _____

A large, empty rounded rectangular box for writing the weekly schedule.

A smaller, empty rounded rectangular box for additional notes or a signature.

Weekly Planner



Week of: _____

A large, empty rounded rectangular box intended for writing the weekly schedule or notes.

A smaller, empty rounded rectangular box at the bottom of the page, likely for a signature or additional notes.

Weekly Planner



Week of: _____

A large, empty rounded rectangular box for writing the weekly schedule.

A smaller, empty rounded rectangular box for additional notes or a signature.

Weekly Planner



Week of: _____

A large, empty rounded rectangular box for writing the weekly schedule.

A smaller, empty rounded rectangular box for additional notes or a signature.

Down on the Farm Book List

Down on the farm theme is giving you the option to buy these books directly from Amazon.com.

If you are interested in checking out any of the books on the down on the farm book list, click directly on the title of the book.

A box will open stating it is trying to connect to - and will give the url of the book you clicked on.

Click on allow - and you will be directed to the description of the book and if you wish to purchase, you can also buy the book from Amazon.com

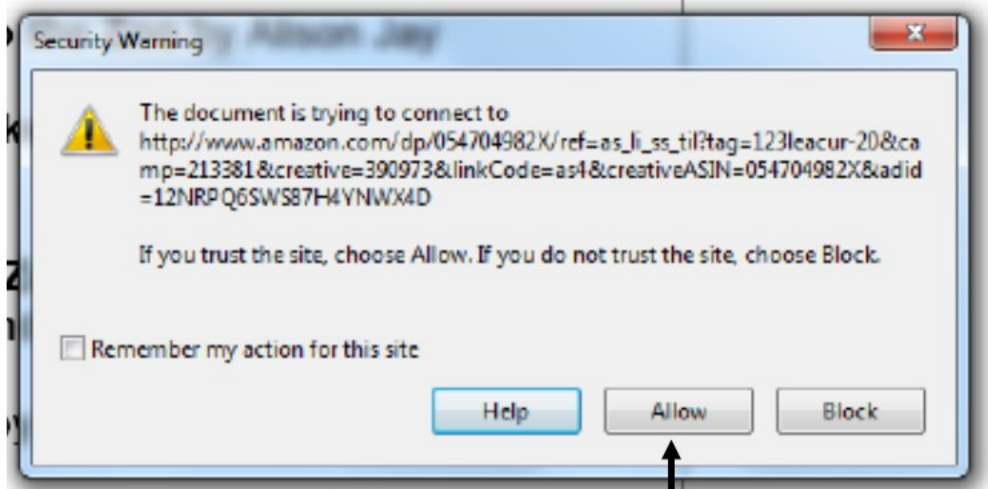

Click on allow to view description of book and to purchase.

Down on the Farm Book List

[Little Blue Truck](#) by Alice Schertle

[Plant & Grow](#) by Jack Redwing

[Night Night Farm](#) by Roger Priddy

[Mrs. Wishy-Washy's Farm](#) by Joy Cowley

[Construction Site: Farming Strong, All Year Long](#) by Sherri Duskey Ringer

[This Farm is Family](#) by Dan McKernan

[A Year at a Farm](#) by Nicholas Harris

[Barnyard Dance](#) by Sandra Boynton

[Pigs! A My Incredible World Picture Book for Children](#)
by My Incredible World

[Cows! A My Incredible World Picture Book for Children](#)
by My Incredible World

[The Cow Who Clucked](#) by Denise Fleming

[Down on the Farm](#) by Merrily Kutner

[Big Red Barn](#) by Margaret Wise Brown

[Pete the Cat: Old McDonald Had a Farm](#) by James Dean



Cover Sheet

The cover sheet is something that can be printed up and hung on your bulletin board.

This will give parents a visual of what theme the children will be working on.

You can place this cover sheet in a top loading page protector.

(You have 4 to choose from)

Down on the Farm



DOWN ON THE FARM





Down on the Farm

Down on the Farm



Large Wall Flashcards

The letter Y, number 4, color pink, shape triangle are available in both color and B & W.

These can be printed on white card stock, laminated and hung up during your Down on the Farm theme.

You can also use the B & W sheets as extra worksheets for the children. Print the worksheets up on regular copy paper.

Large Wall Flashcards

Y – 4 – Pink Triangle
(In color and B & W)

Y y

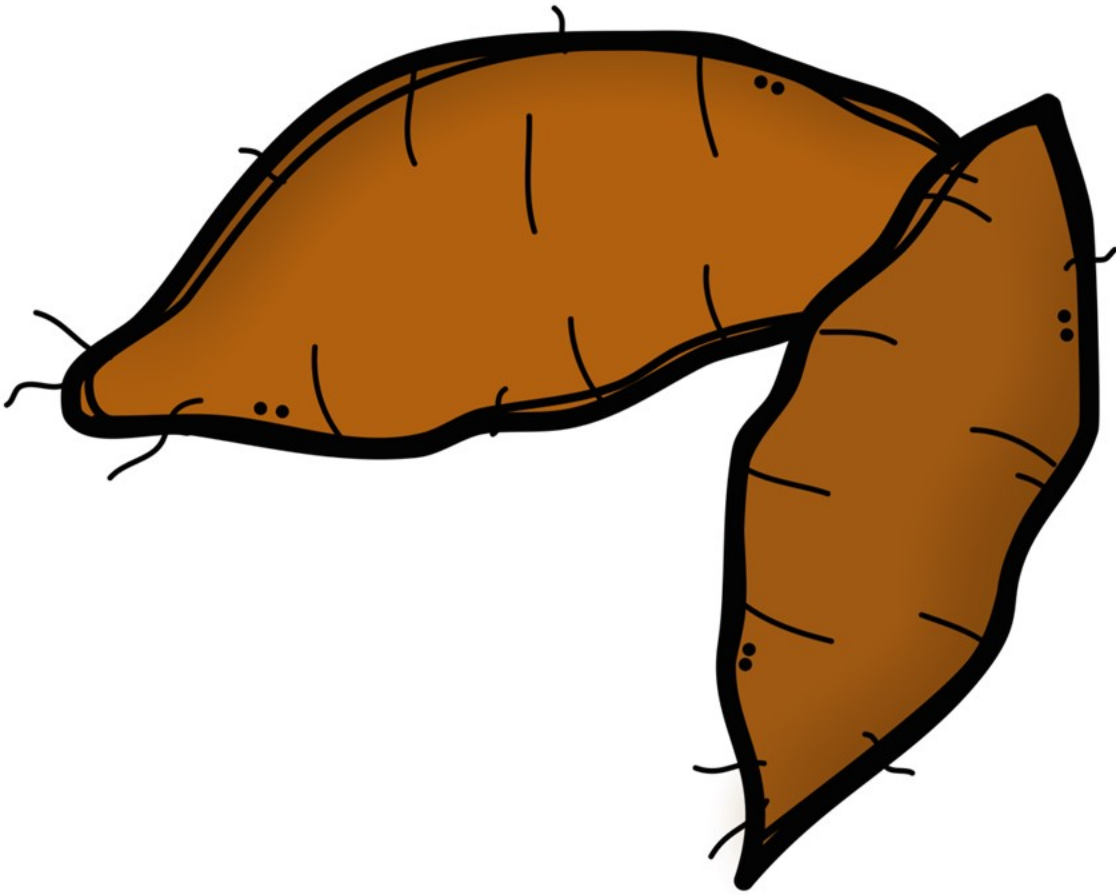

Yams

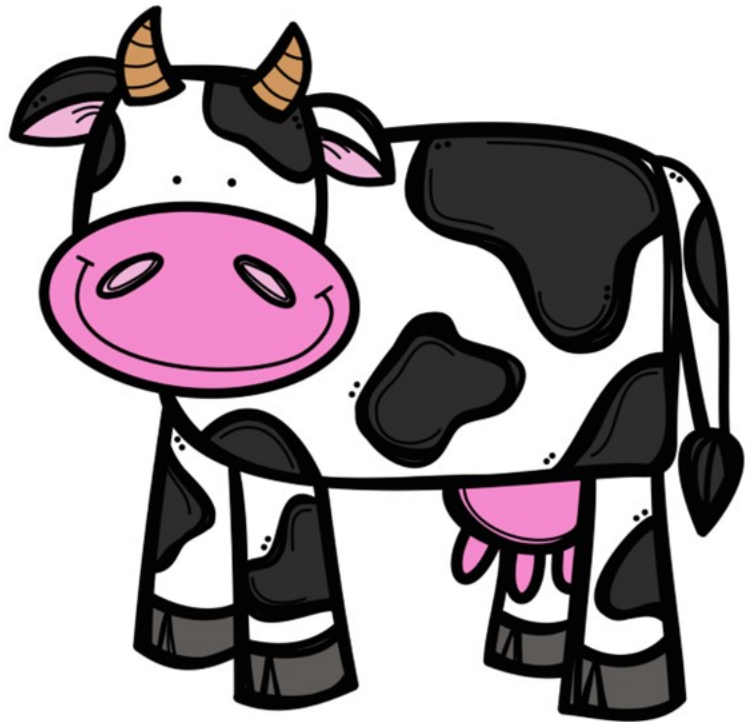
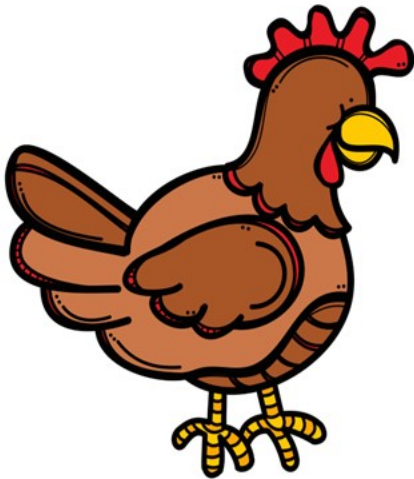
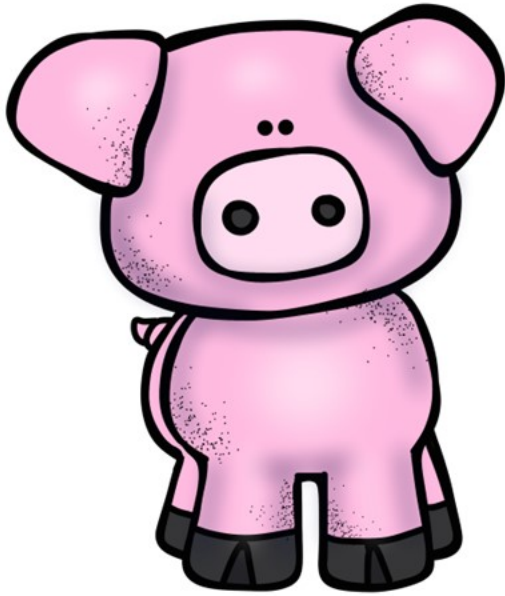

4

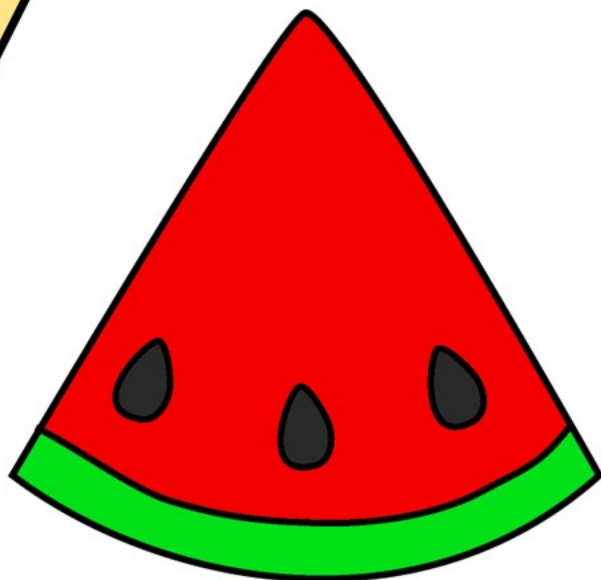
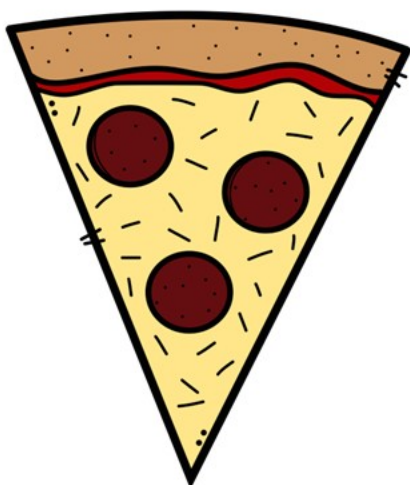

Triangle

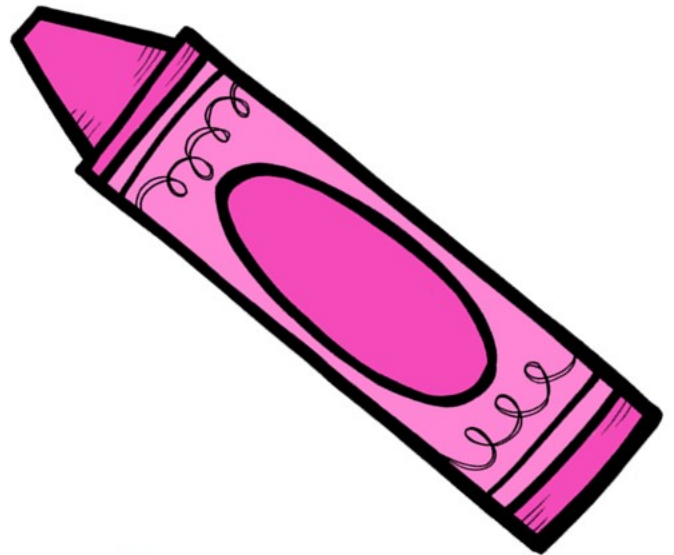
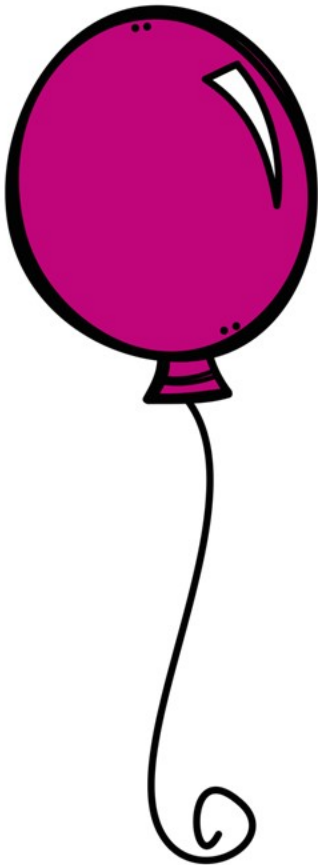
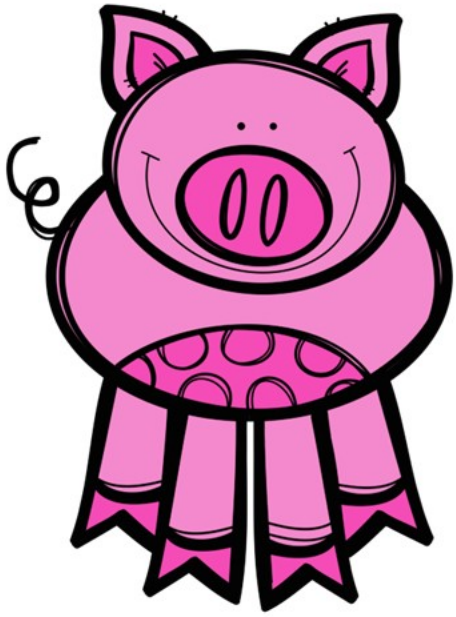

Pink

Y y

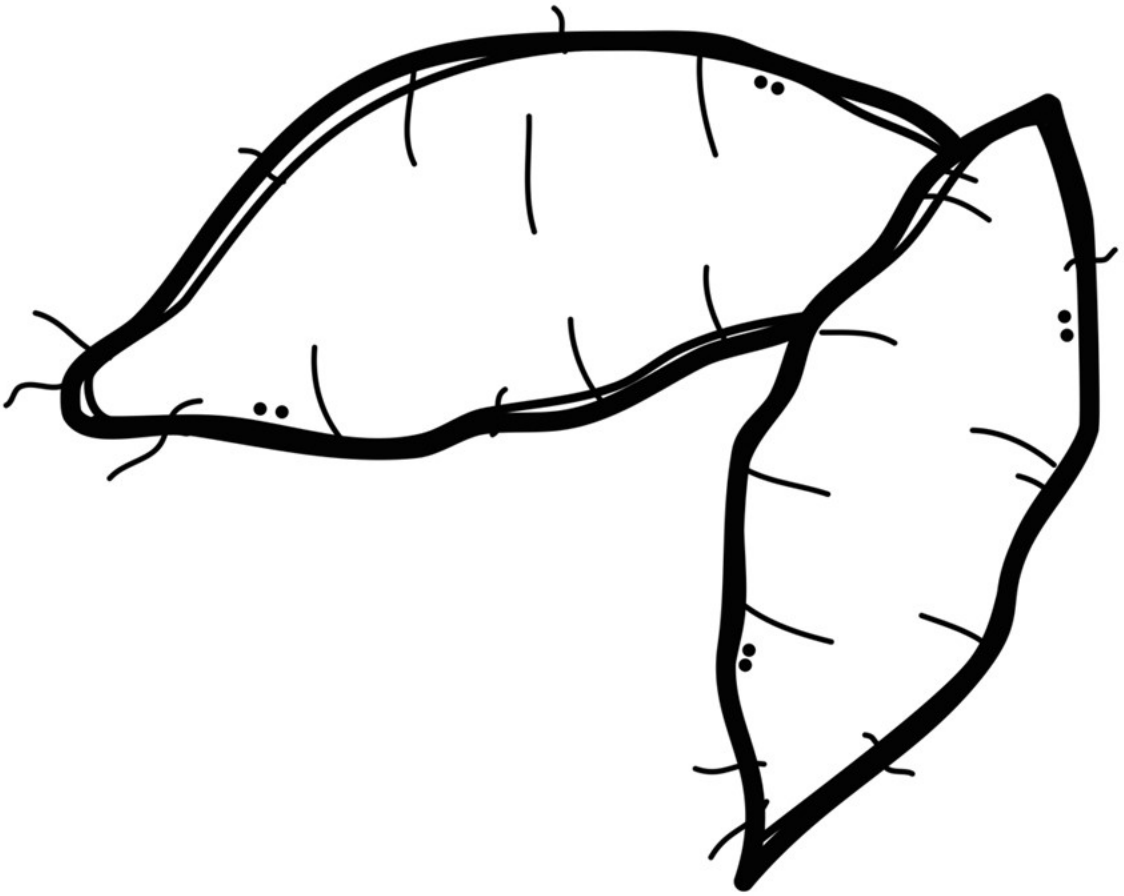

Yams

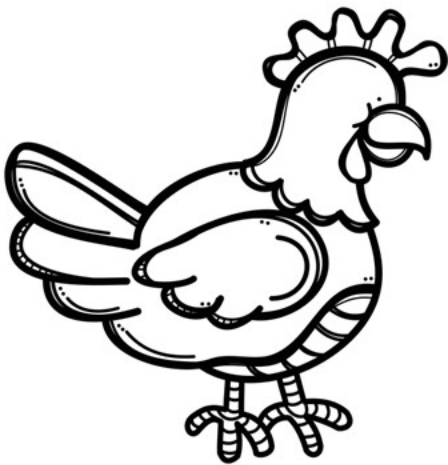
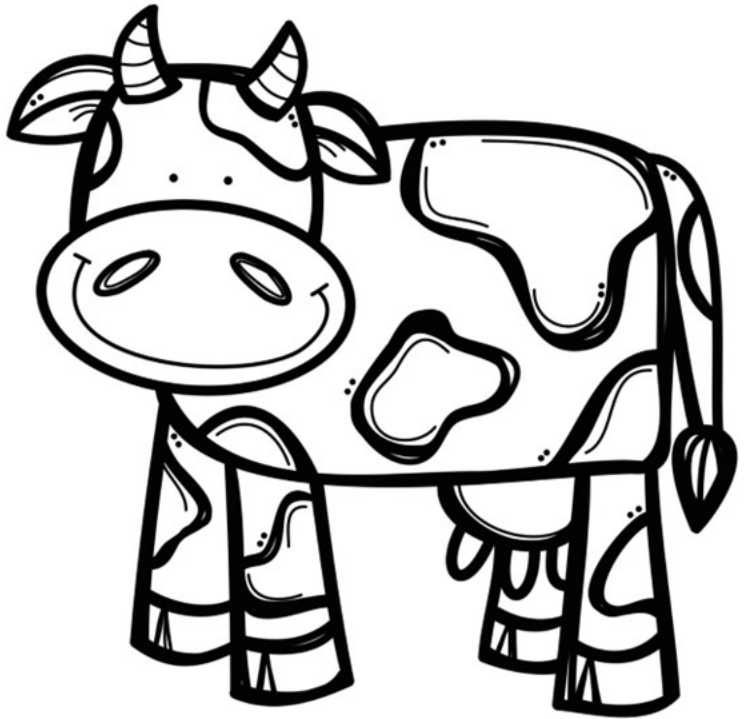
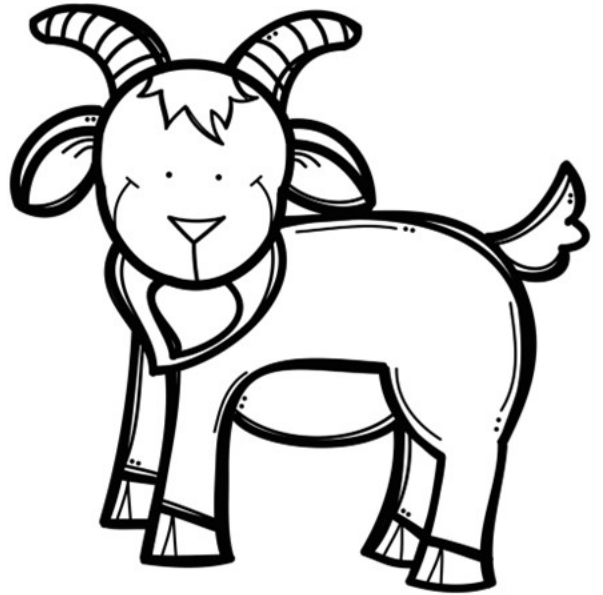
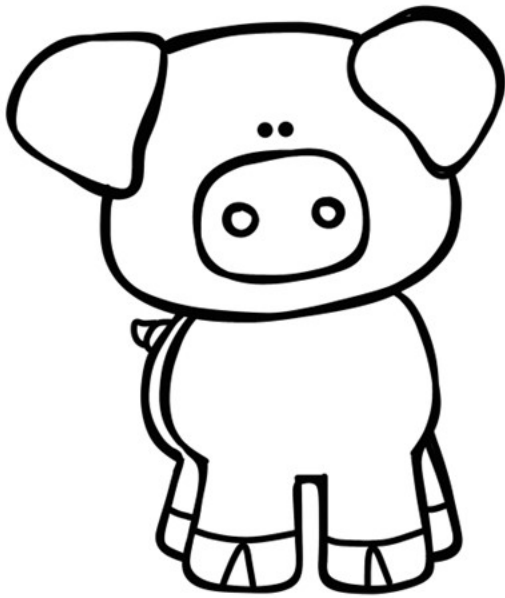

4

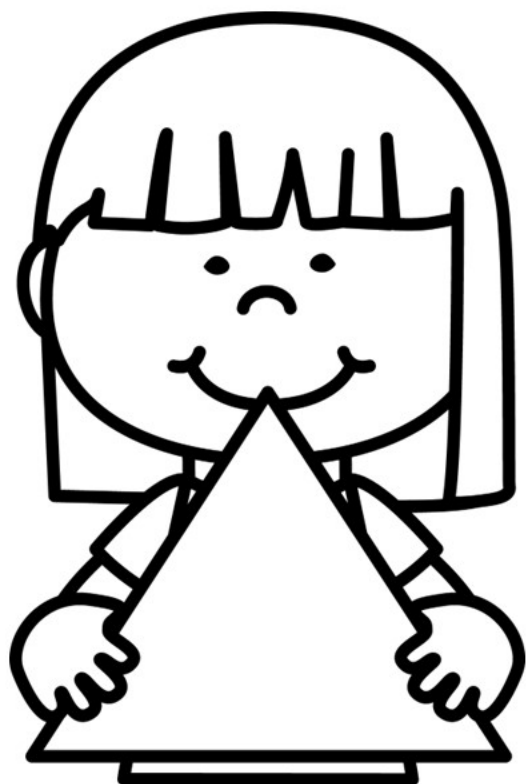
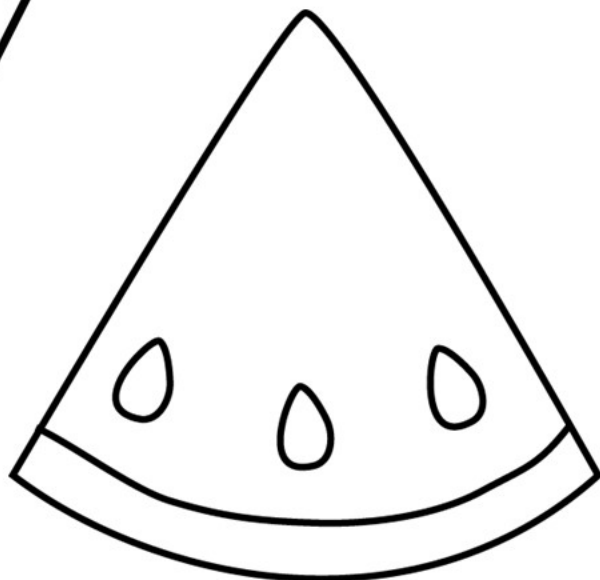
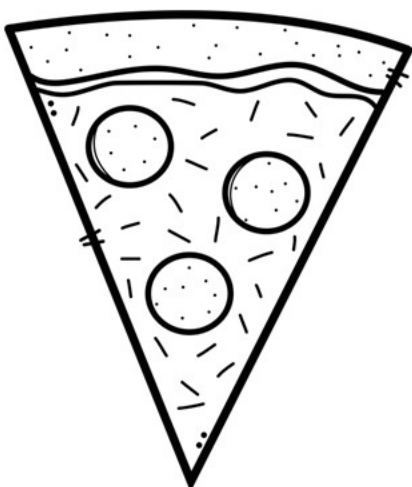

Triangle

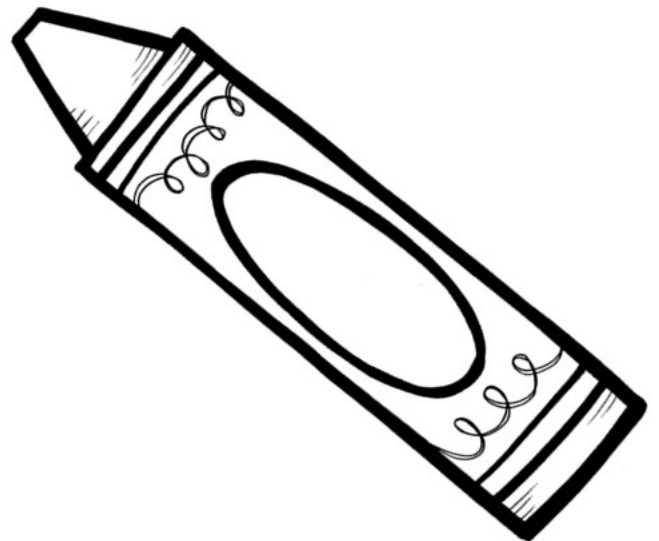
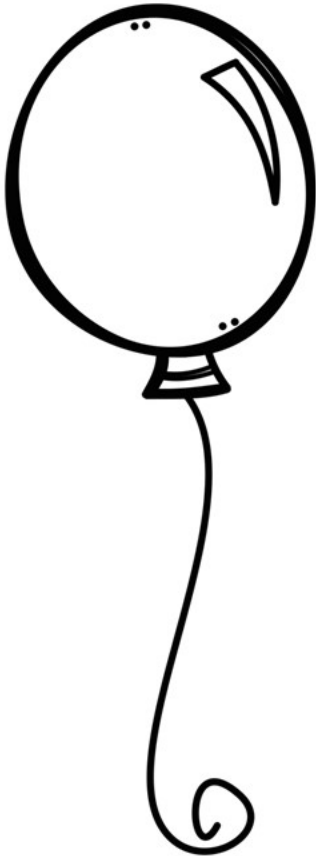
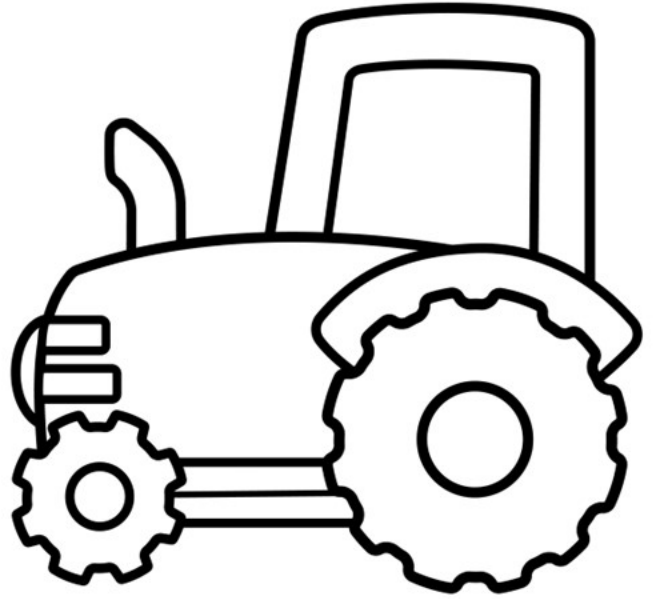
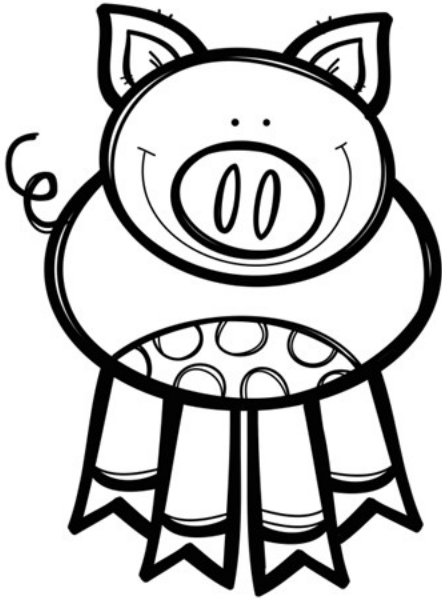

Pink

Large Group Activities

ECIPs

1. Social and Emotional Development
2. Approaches to Learning
3. Language and Literacy Development
4. Creativity and the Arts
5. Cognitive Development
6. Physical and Motor Development

Domain 1: Social and Emotional Development

Component: Social Competence and Relationships

Indicator: Interacts easily with one or more

Domain 2: Approaches to Learning

Component: Curiosity

Indicator: Show eagerness and a sense of wonder as a learner

Domain 3: Language and Literacy Development

Component: Emergent Writing

Indicators: Understand that writing is a way of communicating * Begin to copy or write own name

Domain 4: Creativity and the Arts

Component: Responding

Indicators: Shows others and/or talk about what they have made or done *
Show interest and respect for the creative work of self and others

Domain 5: Cognitive Development

Component: Mathematical and Logical Thinking - Number Concepts and Operations

Indicators: Demonstrates increasing interest in and awareness of numbers and counting * Demonstrate understanding of one-to-one correspondence between objects and number

Domain 6: Physical and Motor Development

Component: Fine Motor Development

Indicator: Explore and experiment with a variety of tools, (e.g., spoons, crayons, paintbrushes, scissors, keyboards)



DOWN ON THE FARM

LARGE GROUP ACTIVITIES



	Theme Worksheets	Letter Y	Number 4	Shape Triangle	Color Pink
Monday	Farm Color – Cut and Glue	Y is for Yawn		Color the Triangles	
Tuesday	Farm Puzzle		How Many Farm Animals – Color and Write the Number 4		Color and Write the Word Pink
Wednesday	Farm Lacing Cards	Words that Start With the Letter Y		How Many Triangles?	
Thursday	Color By Number Farm Animals		Count the Barns – Circle the correct number		Learning the Color Pink
Friday	Farmer Sequencing Color – Cut and Glue	Y is for Yarn		Color the Triangle Shapes	

Monday – Large Group Activities

Color – Cut out on dotted line – Glue onto construction paper.

DOWN ON THE FARM

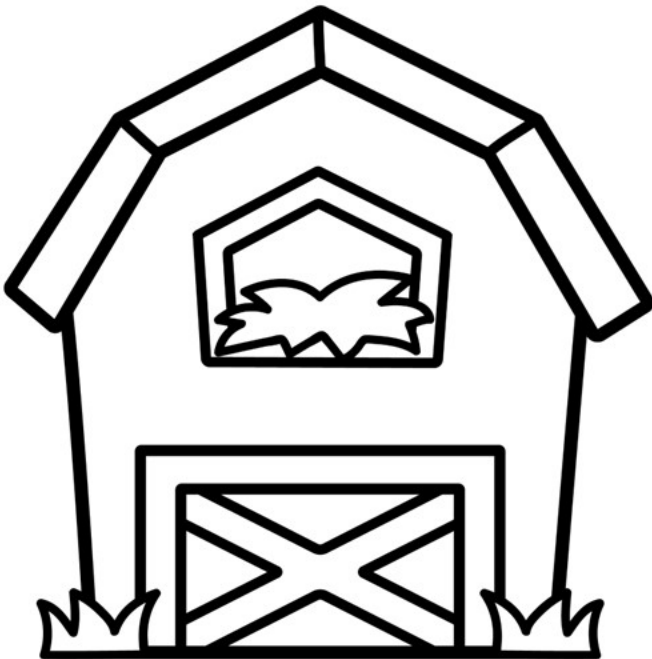
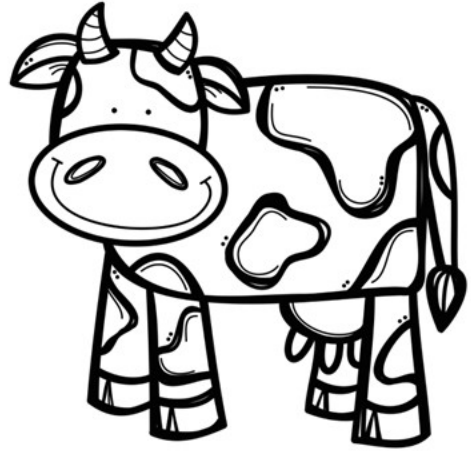

Name _____

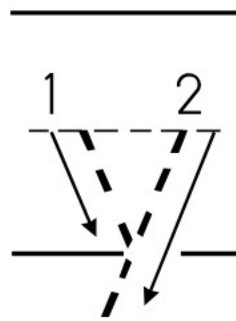
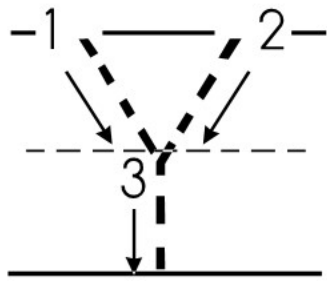

Write the word yawn

yawn

Name _____

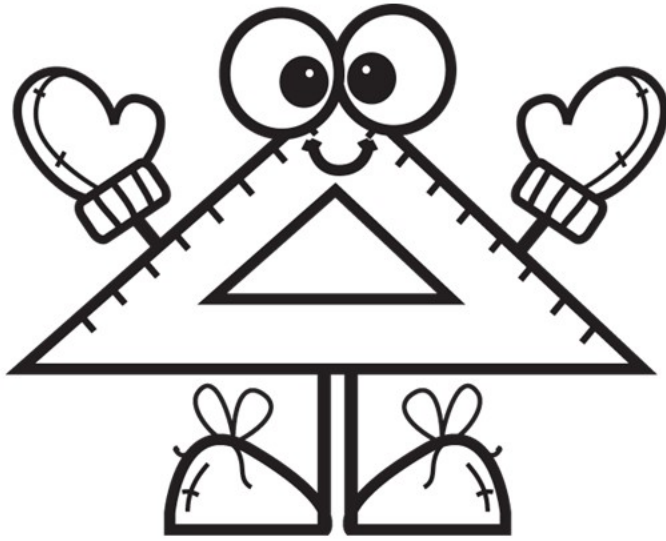

Color

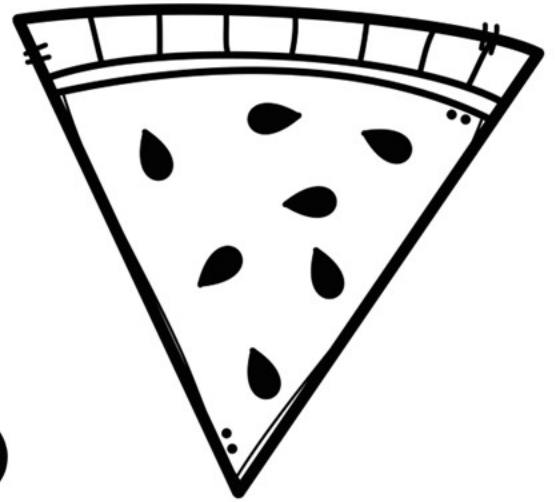

Triangles

Tuesday – Large Group Activities

Farm puzzle – Color, cut out on lines and put together. Glue onto construction paper if desired.

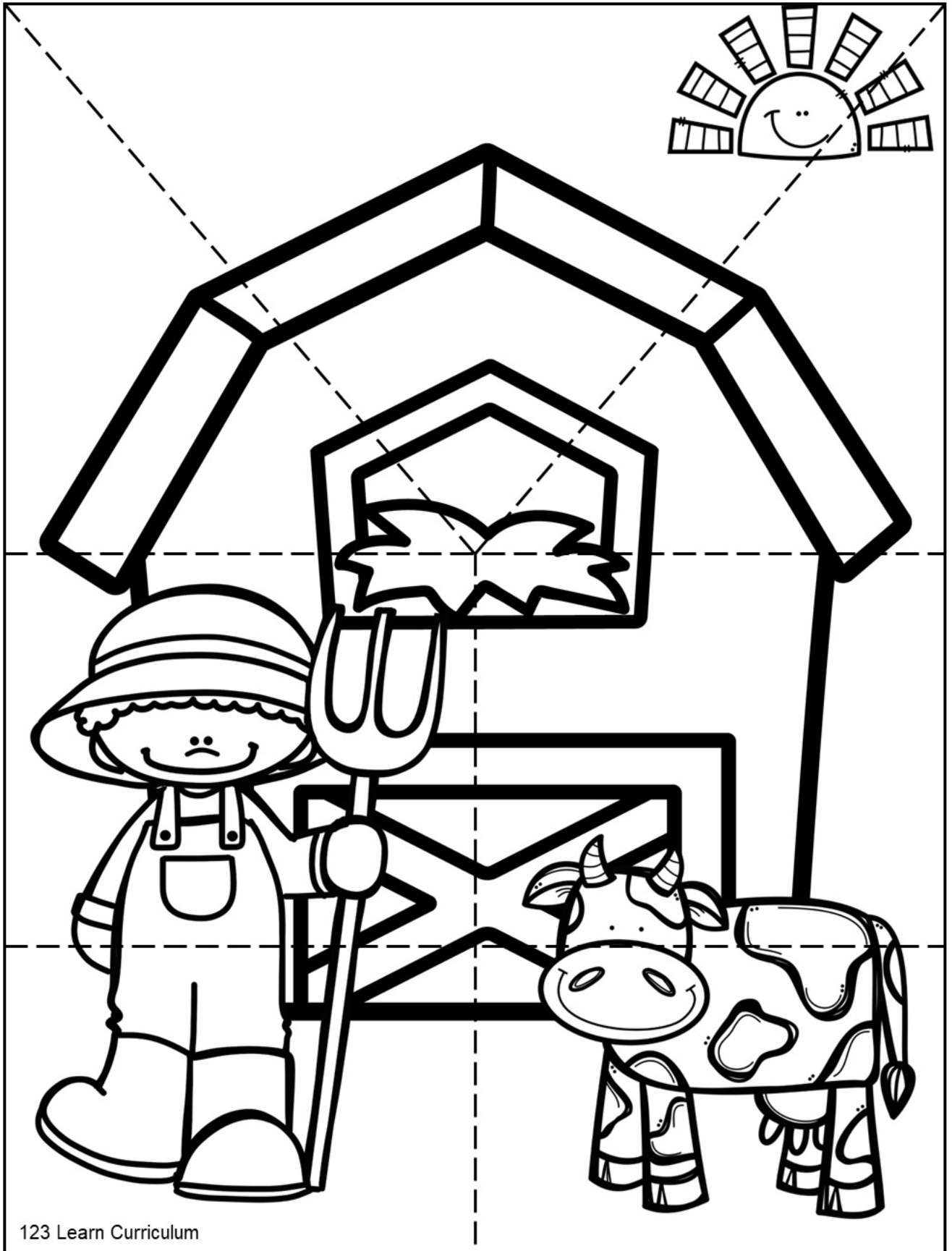

Name _____

How many farm animals? _____

Color

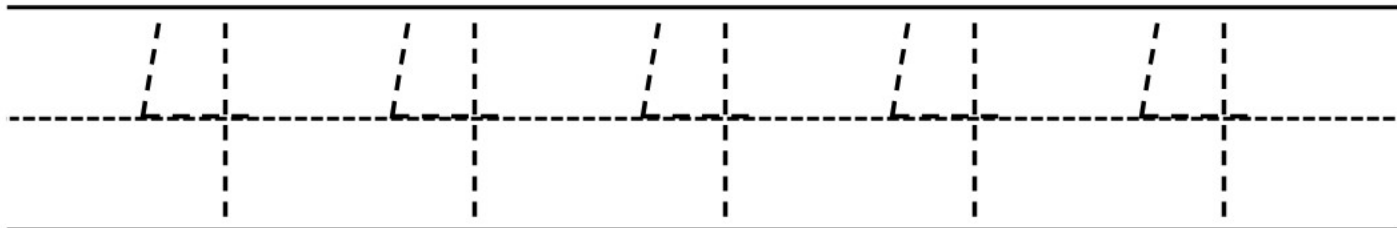
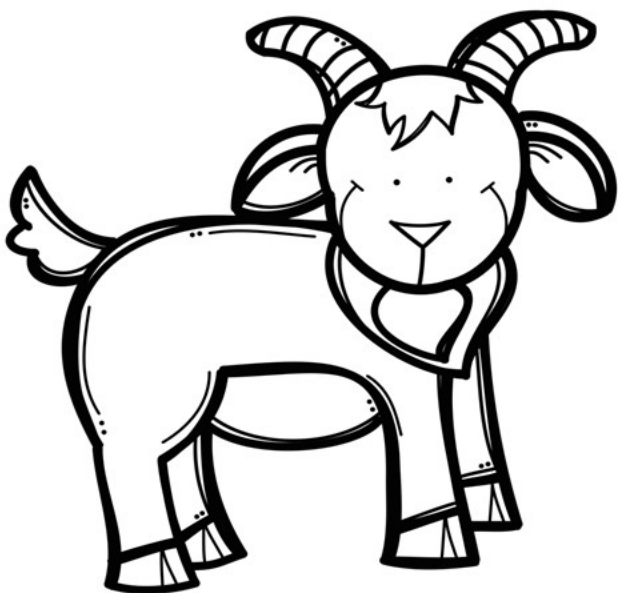
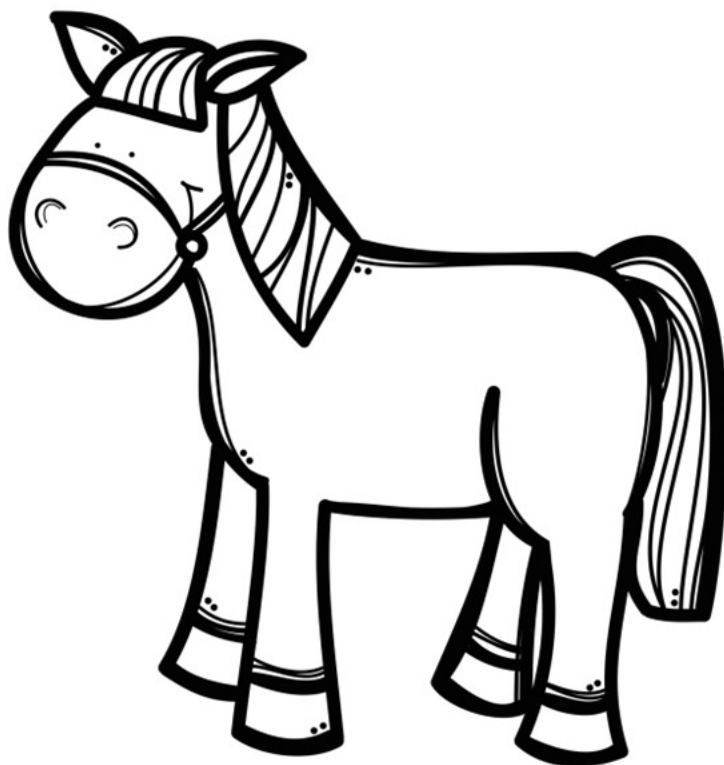
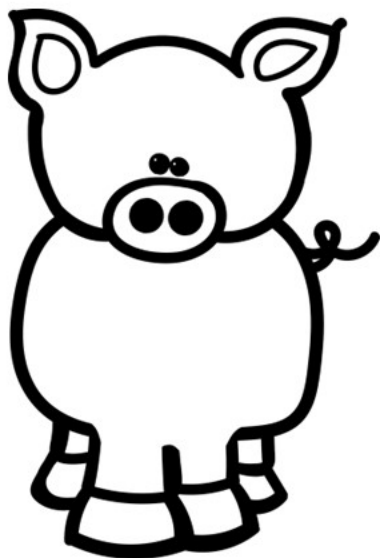
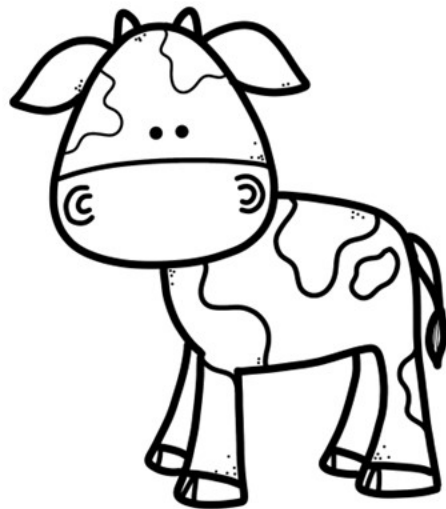

Name _____

Color the crayons pink

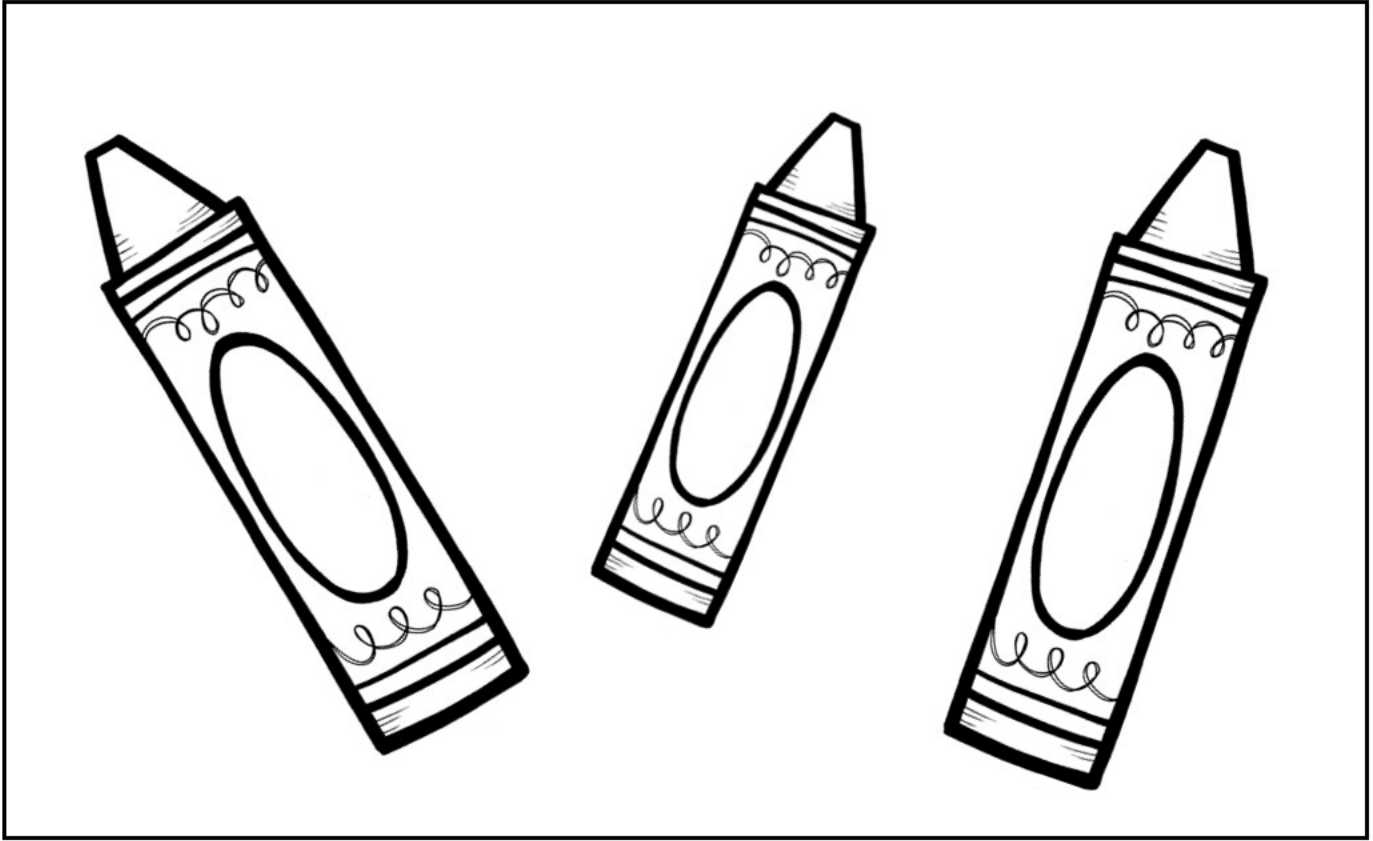

Trace the word.

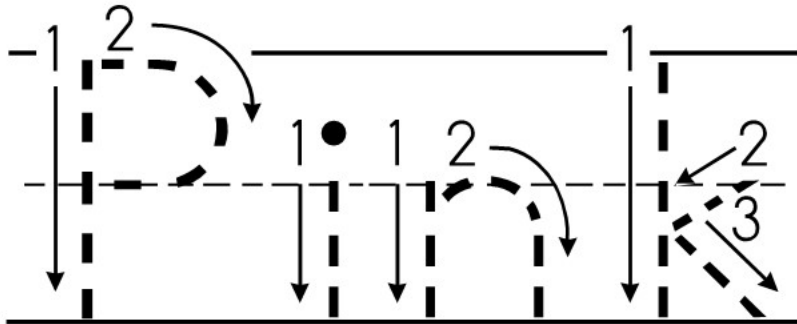

Print the word.

Wednesday – Large Group Activities

Lacing Cards

Children love lacing cards. Print on white card stock, have children color and cut out. Have an adult punch holes and they can lace using the above options of string.

Give the children lacing strings, yarn or shoelaces to lace the cards.

Lacing strings can be purchased through:

<http://www.discountsschoolsupply.com/>

<http://www.lakeshorelearning.com/>

<https://www.amazon.com/>

Type lacing strings in search. 😊

Print up on white card stock. Color - Cut out on the dotted line. Punch holes with a hole punch. Have children lace using lacing string.



Farm Life

Down on the Farm Lacing Card



Farm Life

Print up on white card stock. Color - Cut out on the dotted line. Punch holes with a hole punch. Have children lace using lacing string.

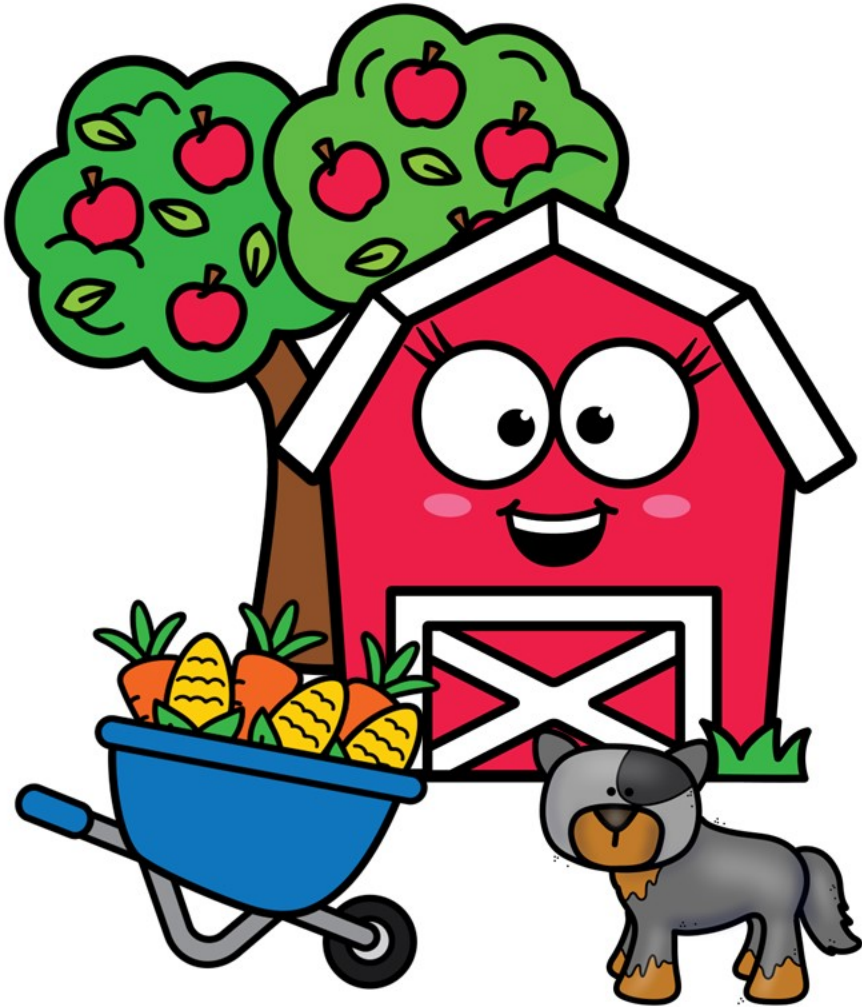

Farm Life

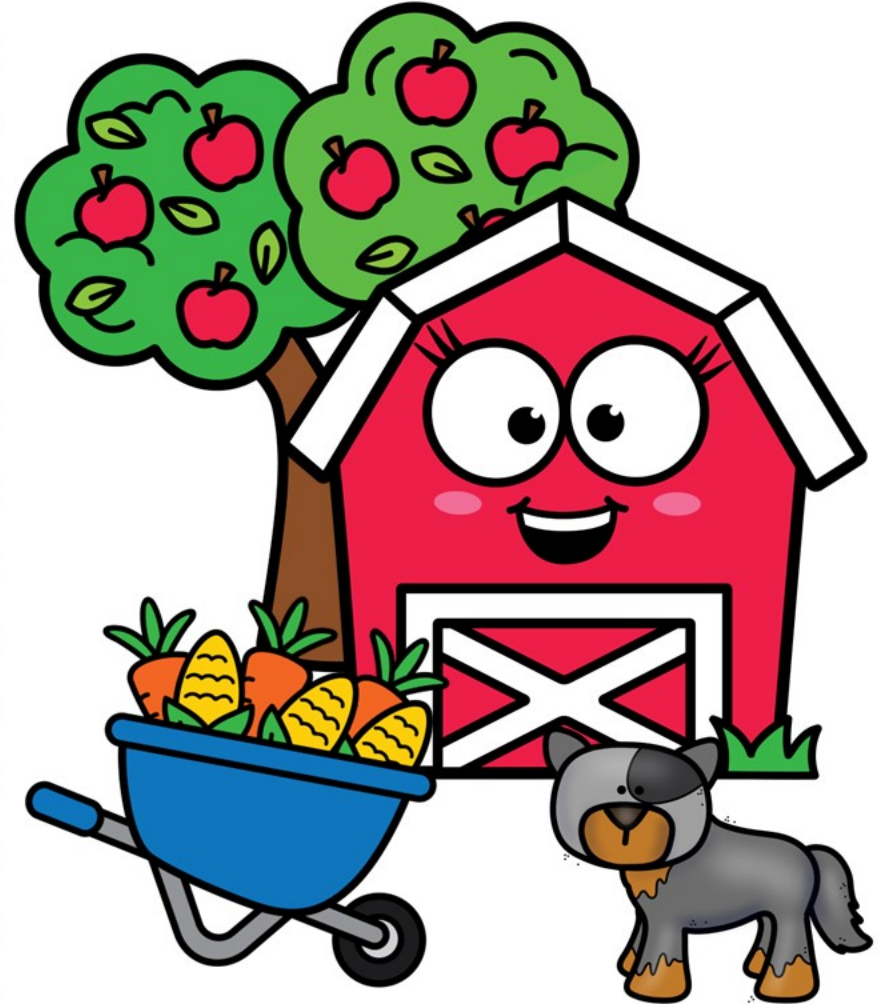

Farm Life

Down on the Farm Lacing Card

Print up on white card stock. Color - Cut out on the dotted line. Punch holes with a hole punch. Have children lace using lacing string.

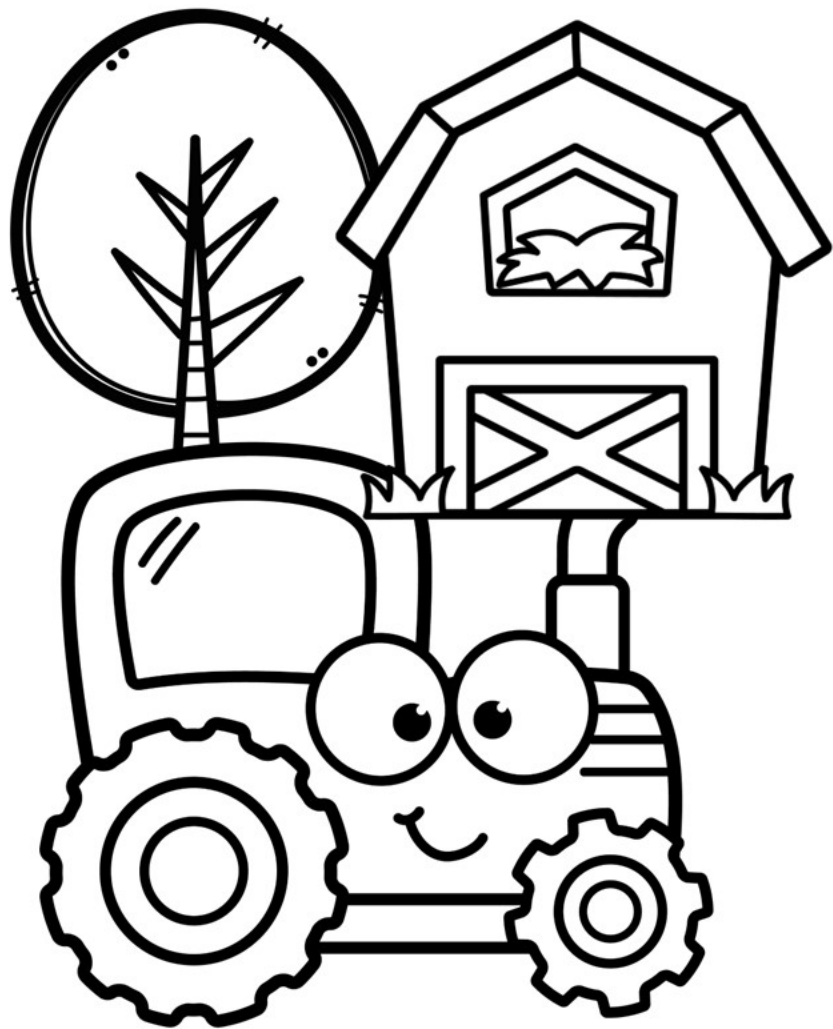

Down on the Farm

Down on the Farm Lacing Card



Down on the Farm

Print up on white card stock. Cut out on the dotted line.
Punch holes with a hole punch. Have children lace using
lacing string.



Down on the Farm

Down on the Farm Lacing Card



Down on the Farm

Print up on white card stock. Color - Cut out on the dotted line. Punch holes with a hole punch. Have children lace using lacing string.



Farm Life

Down on the Farm Lacing Card



Farm Life

Print up on white card stock. Color - Cut out on the dotted line. Punch holes with a hole punch. Have children lace using lacing string.



Farm Life

Down on the Farm Lacing Card



Farm Life

Name _____

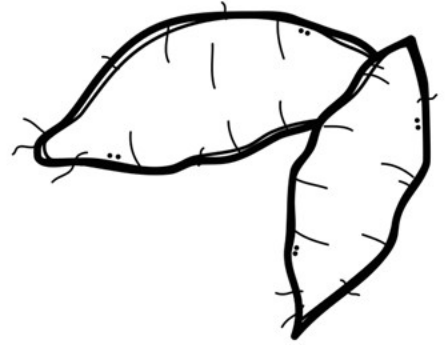
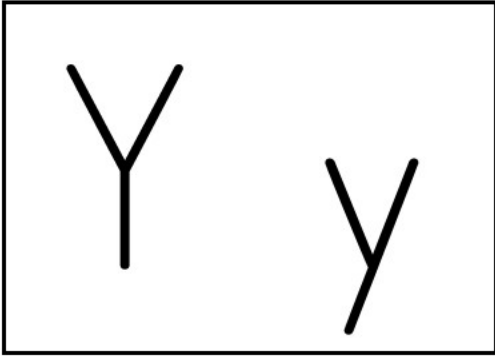

yams

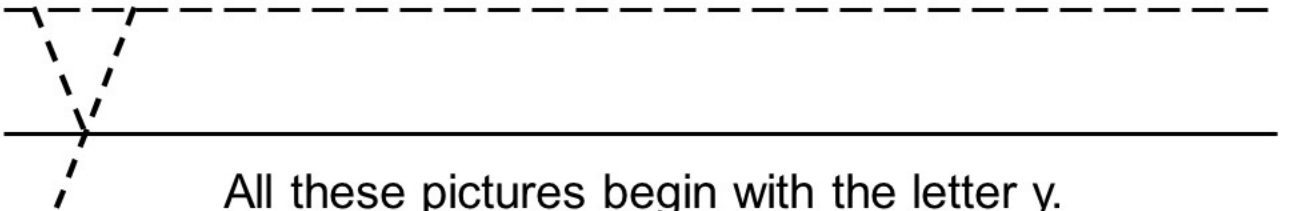
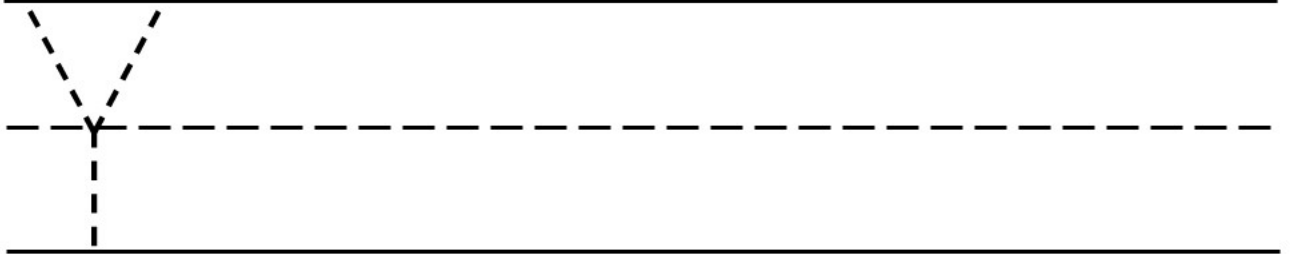

All these pictures begin with the letter y.



yell



yogurt



yo-yo

Name _____

I'm Learning about Triangles

Trace the triangles.

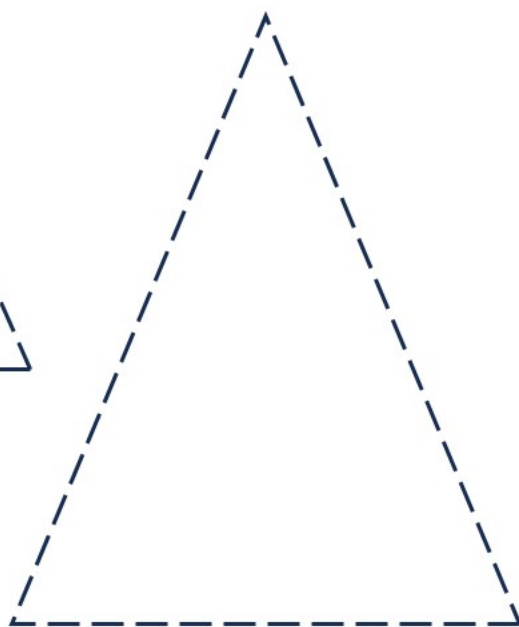
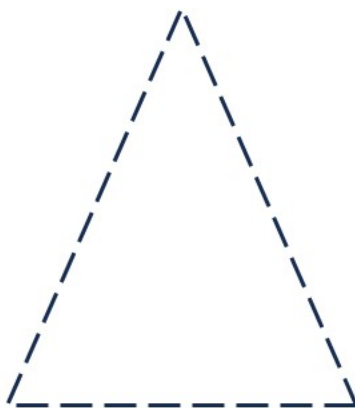
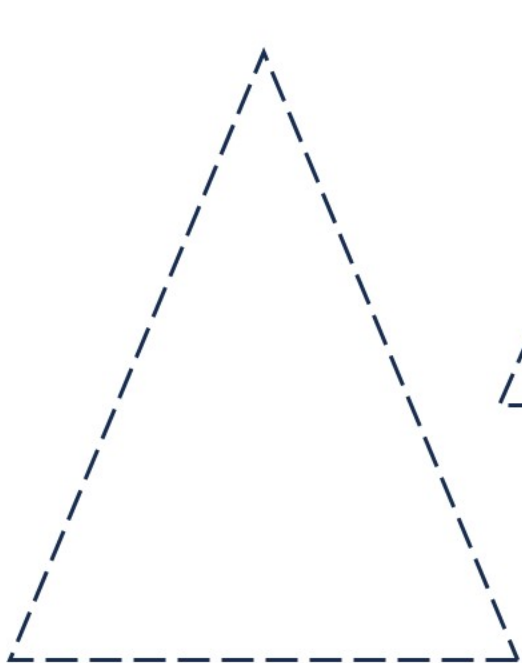
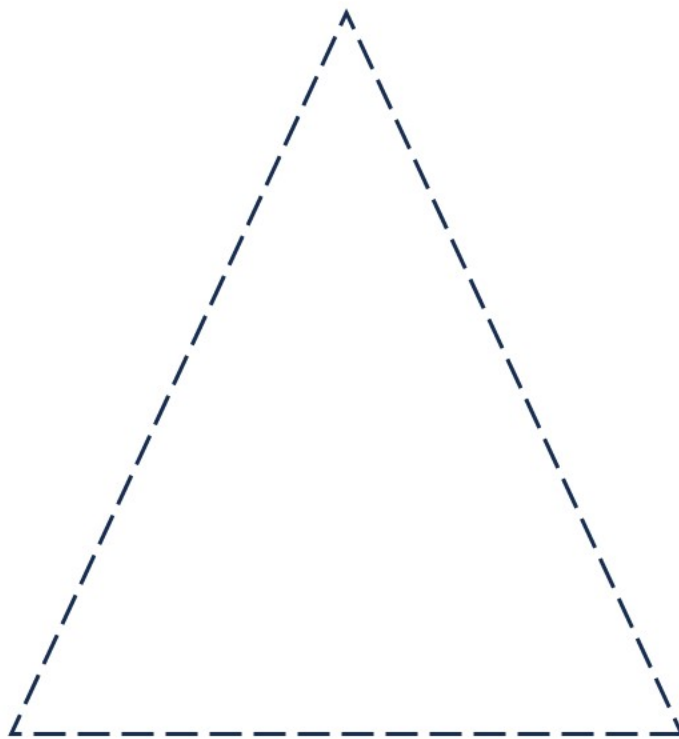
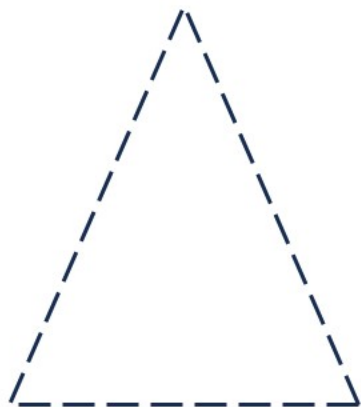

Thursday – Large Group Activities

Name _____

DOWN ON THE FARM

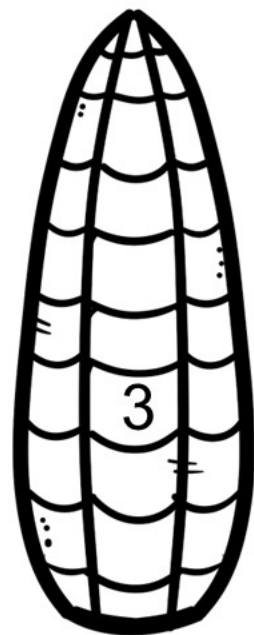

- 1 Red
- 2 Orange
- 3 Yellow
- 4 Green
- 5 Black

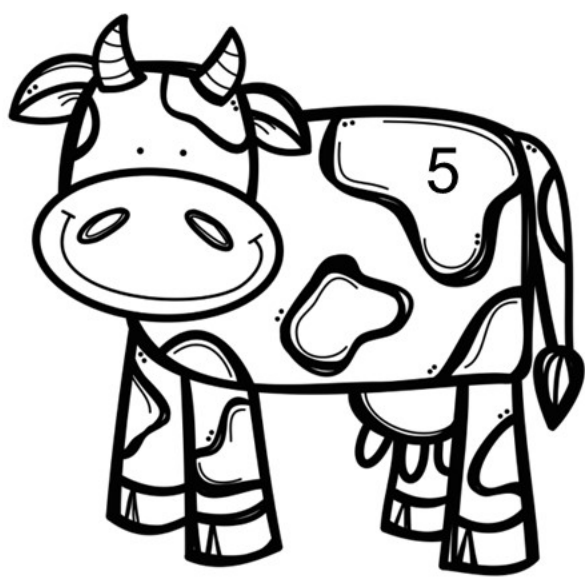
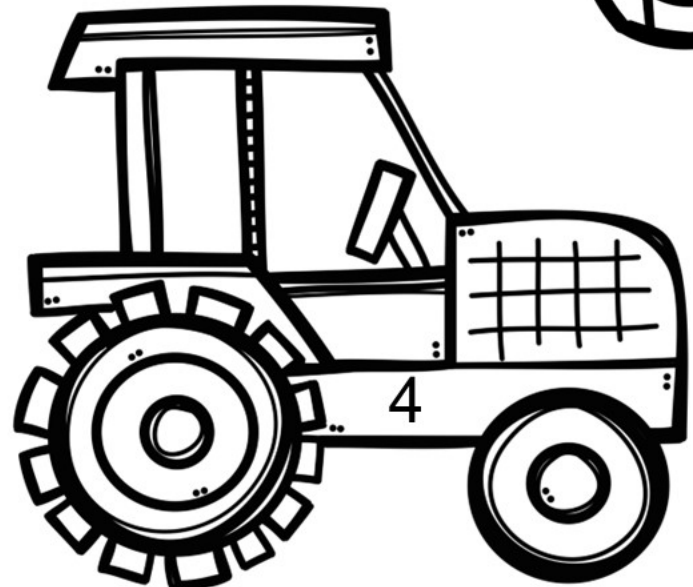

Name _____

4 Barns

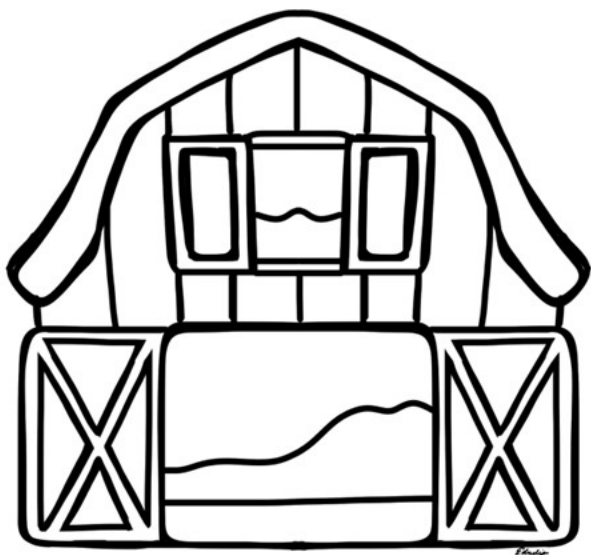

Circle the number 4 - Color

3

4

5

6

7

Name _____

Pink

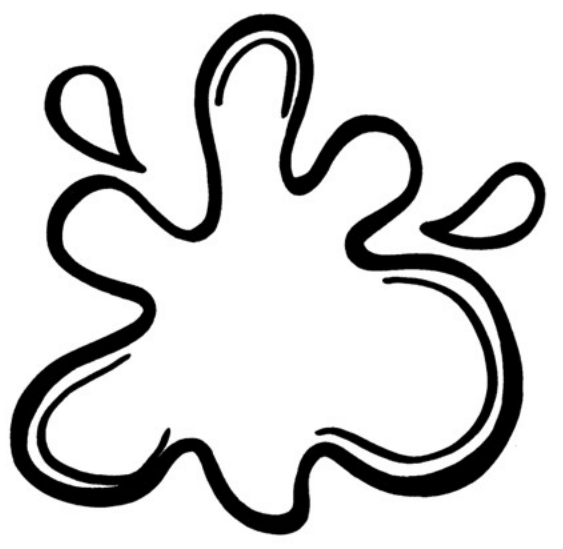
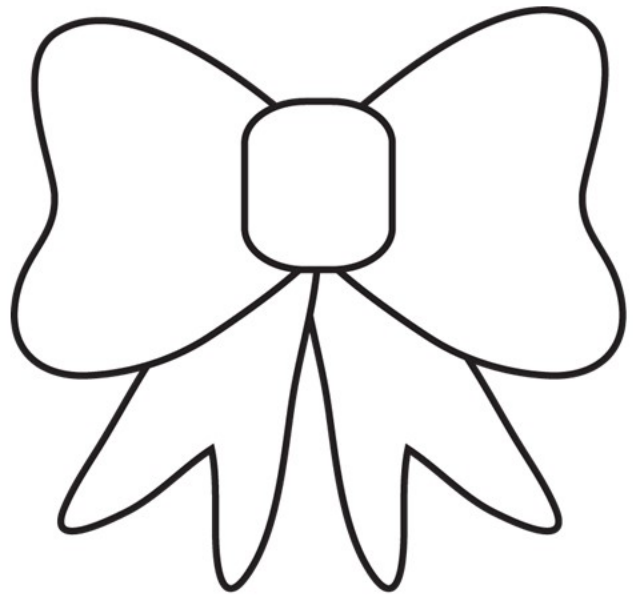
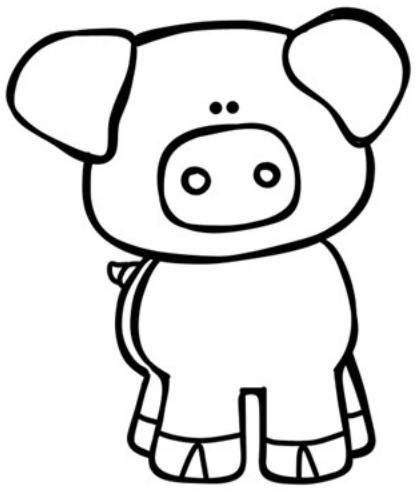

Pink

Friday – Large Group Activities

Farmer Sequencing

Print up the sheet with the 3 farmers on white card stock.

Give to the children to color and cut out. Glue them in sequence – Largest to smallest.

Print up the sequence – Largest to smallest sheet on card stock, or hand print the information on a piece of construction paper.

Name _____

Farmer Sequencing
Large to Small

Large

Medium

Small

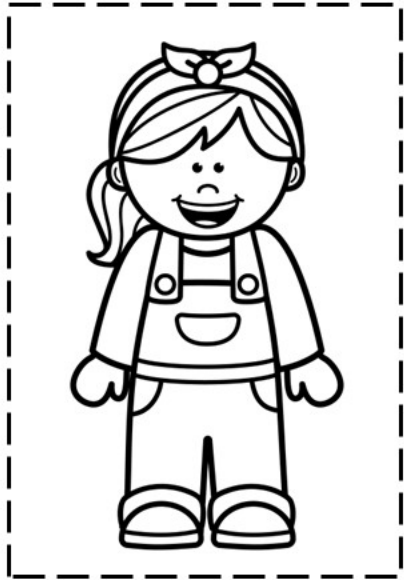
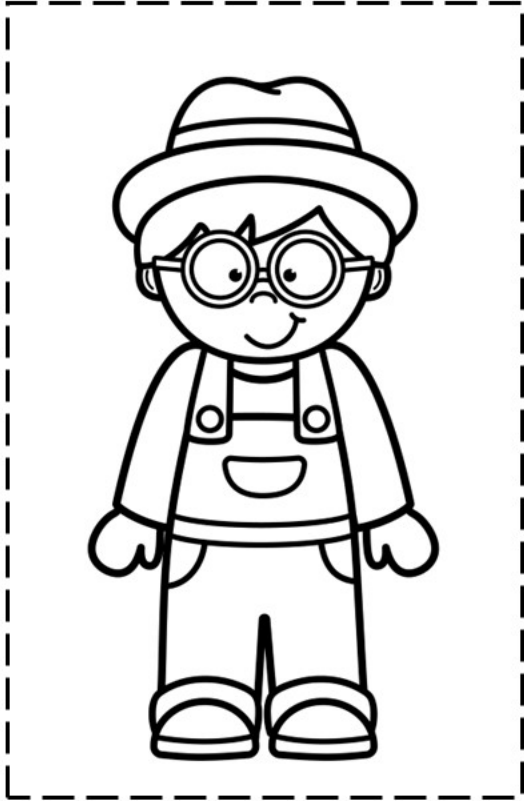
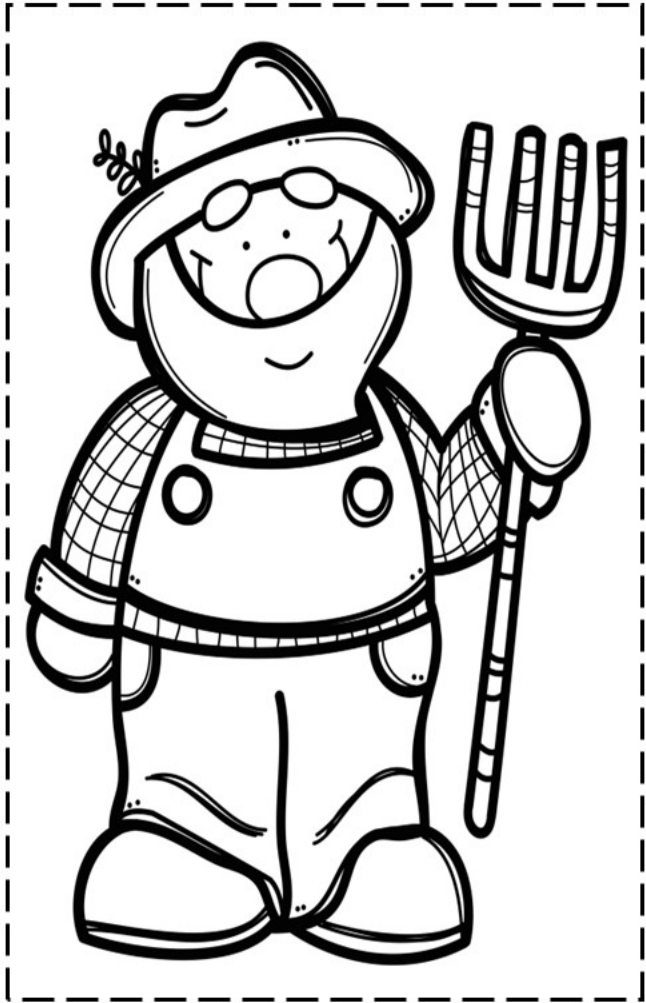

Name _____

Y

y

yarn

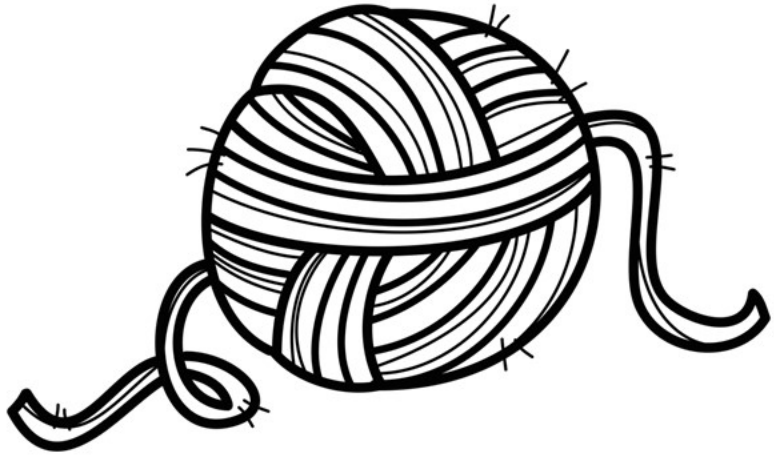

Name _____

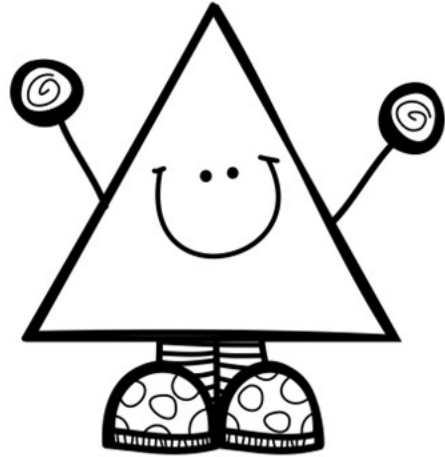
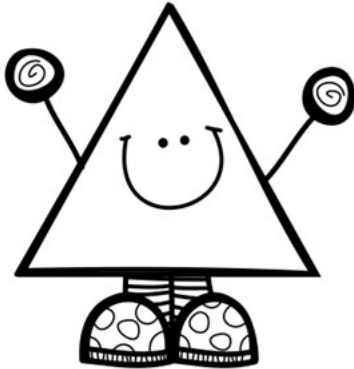
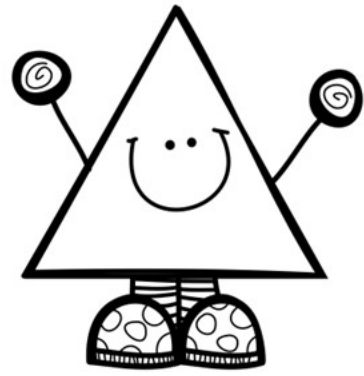
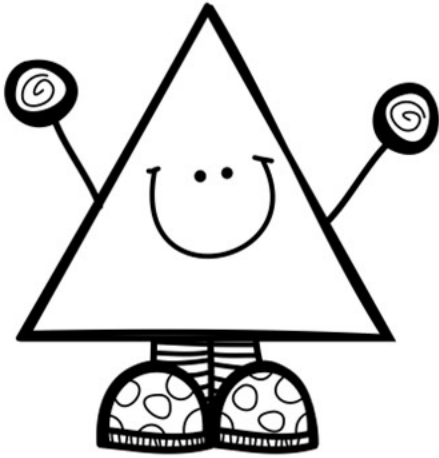

How many triangles? _____

Draw your own triangles.

